

CATALOGUE PRODUITS

Products catalogue

quotes@tipes.co.uk

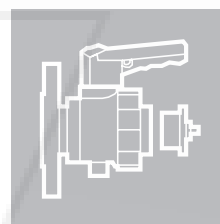
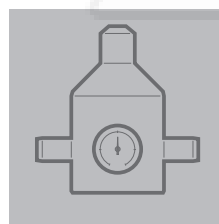
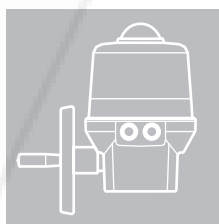
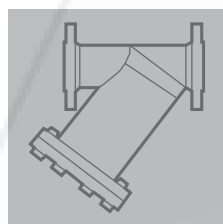
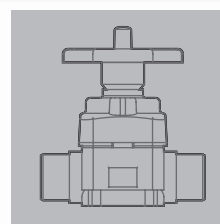
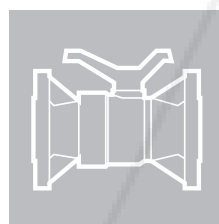
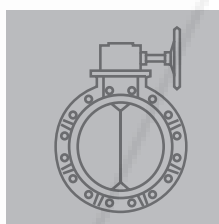
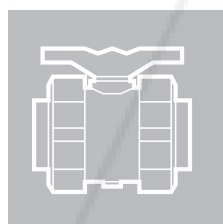

Thermoplastic Valve Solutions
Tel. 01626 201092



Thermoplastic Valve Solutions

SAFi France (HQ)

13, av. Jacques Moison - BP 1
26770 TAULIGNAN CEDEX
FRANCE
Tél. : (+33) 4 75 53 56 29
Fax : (+33) 4 75 53 62 78
info@safi-valves.com

SAFi UK

35 Holton Road
Holton Heath Trading Park
POOLE Dorset - BH16 6LT
UNITED KINGDOM
Tél. : (+44) 1202 624618
Fax : (+44) 1202 628500
sales@safi-valves.com

SAFi Deutschland

Kunststoffarmaturen
Vertriebs GmbH
Jahnstrasse 29
64319 PFUNGSTADT
DEUTSCHLAND
Tél. : (+49) 61 57 81 919
Fax : (+49) 61 57 82 025
info-deutschland@safi-valves.com

SAFi Fabrica de Valvulas

C/ Carboners, 35
Pol. Ind. La Cometa
43700 EL VENDRELL
TARRAGONA-ESPAÑA
Tel. : (+34) 977 665 147
Fax : (+34) 977 664 989
info@safi-valvulas.com

quotes@tfpes.co.uk

SAFi América

Las Garzas Trade Center
Las Garzas #950
Quilicura
SANTIAGO - CHILE
Tfno. : (+56 2) 2 510 3500
info@safi-america.com

SAFi América Perú

Av. José Pardo #601
Oficina 1301
Miraflores
LIMA - PERÚ
Tfno. : (+51) 1 699 8100
peru@safi-america.com

Tel: 01626 201092



EDITO

Stéphane Moison, Président

Cher client,

J'ai le plaisir de vous présenter notre Catalogue Produits version **2020**.

Fidèles à notre engagement de **qualité et de proximité**, nous avons souhaité réaliser un document de terrain, facilitant la sélection et la visualisation des produits, avec des informations techniques directement accessibles.

Ce catalogue est cependant loin d'être exhaustif. Notre **site internet** vous permettra de consulter les dernières nouveautés et télécharger de nombreux documents techniques.

Au-delà des produits, les équipes SAFI sont à votre **service** partout dans le monde pour vous apporter des **solutions**. N'hésitez donc pas à les contacter.

Bonne lecture !

Dear Client,

I am pleased to introduce you the 2020 version of our Products Catalogue.

Loyal to our commitment to **quality and proximity**, we wanted to produce a pragmatic document, facilitating the selection and visualization of products, with technical information directly accessible.

This catalog is however far from being exhaustive. Our **website** will allow you to consult the latest news and download many technical documents.





































Beyond products, SAFI teams are at your **service** all over the world to bring you **solutions**. Do not hesitate to contact them.





























Have a pleasant reading.

NOTRE GAMME DE PRODUITS
Our products range

quotes@tfpes.co.uk

INDUSTRIAL VALVES

		PVC-U	PVC-C	PP-H	PPGF	PP-EL	PVDF
ROBINET À TOURNANT SPHÉRIQUE Ball valve	COMPACT À BRIDES Flanged compact						
					P62	P78	P82
	DOUBLE UNION Double union						
		P26	P40	P48	P64		P84
ROBINET À TOURNANT SPHÉRIQUE Ball valve	MULTIVOIES Multiport						
					P66		P85
ROBINET À TOURNANT SPHÉRIQUE Ball valve	AUTRES Others						
		P28			P71		
ROBINET À MEMBRANE Diaphragm valve	MÂLE DOUBLE UNION, À BRIDES Metric spigot, Double union, Flanged						
		P29	P42	P50			P87
ROBINET À PAPILLON Butterfly valve	À POIGNÉE OU À RÉDUCTEUR À VOLANT With hand lever or handwheel						
		P31	P43	P52			P89
ROBINET À PAPILLON Butterfly valve	REGISTRE DE VENTILATION Ventilation damper						
				P53			
CLAPET Check valve	À BATTANT WAFER Wafer swing check valve						
		P32		P54			P94
	À BATTANT ENTRE BRIDES Flanged swing check valve						
	P33	P44	P54			P94	
CLAPET Check valve	À BILLE OU CÔNE Ball or cone check valve						
		P34	P45	P55	P73		P91
FILTRE EN Y Y Strainer	MÂLE À SOUDER, DOUBLE UNION, À BRIDES Metric socket, Double union, Flanged						
		P35		P56			P95

FITTINGS	EMBOUTS & RACCORDS Fittings & End connections	TOUS NOS EMBOUTS ET RACCORDS SONT PRÉSENTÉS DE LA PAGE 100 À 113. All our fittings and end connections are described from page 100 to 113.					
		Femelle à coller Solvent sockets 	Tarauté Threaded 	Brides Flanges 			
OPTIONS	OPTIONS & ACCESSOIRES Options & Accessories	Femelle à souder Fusion welding socket 	PE mâle PE Spigot 	Autres Other 			
		Trou de dégazage Gaz release hole 	Système de cadennage Locking system 	Inserts Lug Lug inserts 			
FLOW CONTROL	ROBINETS DE CONTRÔLE DES FLUIDES Flow control valves	Kit de réparation Maintenance kit 	Enveloppe de protection Safety Shield 	Joint plats Flat gaskets 			
		Regard de coulée Sight glass 	Débitmètre Flowmeter 	Réducteur de pression Pressure reducer 			
IBC VALVES	ROBINET & ACCESSOIRES DE CUVES Valves & accessories for IBC	Détendeur de pression Pressure retaining valve 	Soupape de décharge Pressure relief valve 	Séparateur à membrane Diaphragm pressure gauge guard 			
		Robinet à tournant sphérique de cuve IBC Ball valve 	Couvercle Manhole cover 	Soupape Tank vent 			
ACTUATION	KITS & ACTIONNEURS Kits & actuators	Traversée de cloison Bulkhead fitting 	Accessoires Accessories 				
		Kit de motorisation Actuation kit 	Robinet à membrane motorisé Actuated diaphragm valve 	Guide de motorisation Actuation guide 			
		Actionneur pneumatique Pneumatic actuator 	Actionneur électrique Electric actuator 				



since
1963

SAFI, 1^{er} fabricant français de robinetterie thermoplastique industrielle

Fondée en 1963 par Jacques MOISON, SAFI conçoit et fabrique pour les **industries les plus exigeantes** une large gamme de robinets thermoplastiques.

Qu'il s'agisse d'un robinet de notre catalogue ou d'une **solution spécifiquement développée** pour votre besoin, SAFI met son expérience et sa capacité d'innovation au service de la **sécurité** et la **performance** de votre installation.

Société familiale depuis plus de 50 ans, SAFI vous garantit une relation à taille humaine, assurant un **service de proximité, technique et dynamique.**

Où que vous soyez **à travers le monde**, SAFI vous accompagne via ses **filiales** et un large **réseau international** de revendeurs.

SAFI, 1st French manufacturer of industrial plastic valves

Founded in 1963 by Jacques MOISON, SAFI designs and manufactures for the **most demanding industries** a wide range of thermoplastic valves.

From a standard product available in our catalogue to a **solution specifically designed** for you, SAFI dedicates its experience and its innovation skills to improve the **safety** and the **performance** of your process.

As a family business for more than 50 years, SAFI guarantees you a relation at a human scale, providing a close **service, technical and reactive.**

Wherever you are **in the world**, SAFI will support you through its **subsidiaries** and large **international network** of resellers.

55 années d'expérience

Dédiée à la conception et la production de robinetterie plastique industrielle dès sa création en 1963, SAFI est aujourd'hui un des leaders européens de son secteur.

55 years of experience

Dedicated to the design and production of industrial plastic valves since its creation in 1963, SAFI is today one of the European leaders in its sector.

70 pays couverts

SAFI vous propose ses produits et services à travers un large réseau de filiales et de revendeurs. Nos équipes se déplacent sur site, où que vous soyez dans le monde.

70 countries addressed

SAFI offers its products and services through a large network of subsidiaries and resellers. Our teams come to your site, wherever you are in the world.

15 langues parlées

L'international n'est pas une stratégie, c'est un état d'esprit. Chez SAFI, nous nous enrichissons de cultures différentes.

15 languages spoken

International is not a strategy, it is a state of mind. At SAFI, we enrich ourselves with different cultures.

8 000 produits référencés

Notre catalogue, riche de nos 55 ans d'existence, nous permet de vous proposer une large gamme de produits standards au design éprouvé.

8000 referenced products

Our catalog, rich of our 55 years of existence, allows us to offer you a wide range of standard products with a proven design.

NOS MARCHÉS

Our markets

Présente dans plus de 70 pays, SAFI offre des solutions en robinetterie thermoplastique pour les industries suivantes :

With a presence in more than 70 countries, SAFI offers solutions in thermoplastic valves for the following industries:

Traitement d'eau
& Environnement

Water treatment
& Environment



Industrie chimique

Chemical industry



Transport & stockage de fluides

Transport & storage of fluids



Industrie minière

Mining industry



Traitement de surface

Surface treatment



Agroalimentaire

Food products



Energie

Energy



Pulvérisation agricole

Crop sprayers



Oil & gas

Oil & gas



Industrie navale

Naval industry



Remplacement des robinets métalliques

Replacing metal valves



quotes@tfpes.co.uk

Tel: 01626 201092

www.safi-valves.com

PERSONNALISATION & DÉVELOPPEMENT SUR MESURE

Customization
& Taylor made development



R&D et innovation

Consacrant une large part de son budget à la R&D et l'innovation, SAFI dispose de logiciels de simulation de dernière génération et de son propre laboratoire d'essais.

Qu'il s'agisse de la personnalisation d'un produit existant ou d'un développement complet sur mesure, notre équipe technique est à votre disposition pour répondre à vos besoins les plus spécifiques.

R&D and innovation

Dedicating a large part of its budget to R&D and innovation, SAFI owns last generation simulation softwares and a trials laboratory.

From the customization of an existing product to an entire bespoke development, our technical team is at your disposal to answer to your most specific needs.

PERSONNALISATION DE PRODUIT Product customization

SAFI sait adapter ses produits aux contraintes de votre process : choix de motorisation et capteurs de fin de course, rallonge de commande, connexions spécifiques, identifications, peinture, etc.

SAFI can customize its products to the constraints of your process: choice of actuator and limit switches, lever extension, specific connections, tagging, painting, etc.

Limit Switch Box
SS316

Pneumatic
Actuator SS316

Filter Regulator

Flange Ball Valve
in PVDF

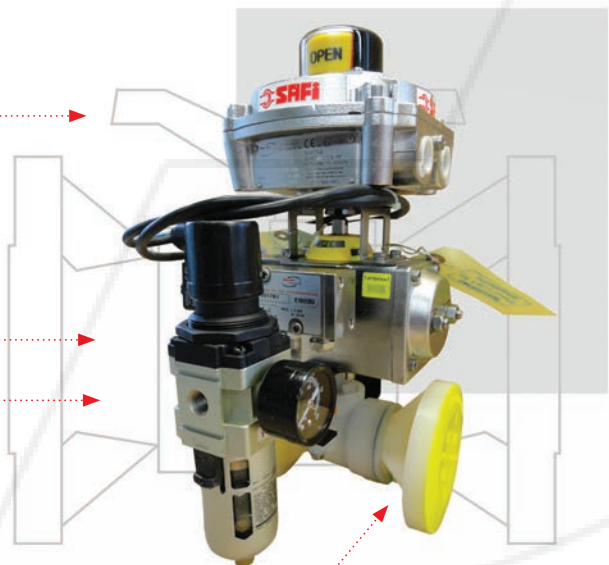



Notre expérience au service de vos besoins spécifiques
Our experience dedicated to your specific needs

quotes@tfpes.co.uk

DÉVELOPPEMENT SUR MESURE
Taylor made development

SAFI offre ses compétences dans la conception et la production de robinets entièrement réalisés sur mesure. Nos prestations vont de l'établissement du cahier des charges technique et industriel jusqu'à la production des robinets, chaque projet étant personnalisé en fonction des besoins de notre client.

SAFI offers its expertise in the design and production of taylor made valves. Our services range from the establishment of technical and industrial specifications to the production of the valves. Each project is customized according to the needs of our client

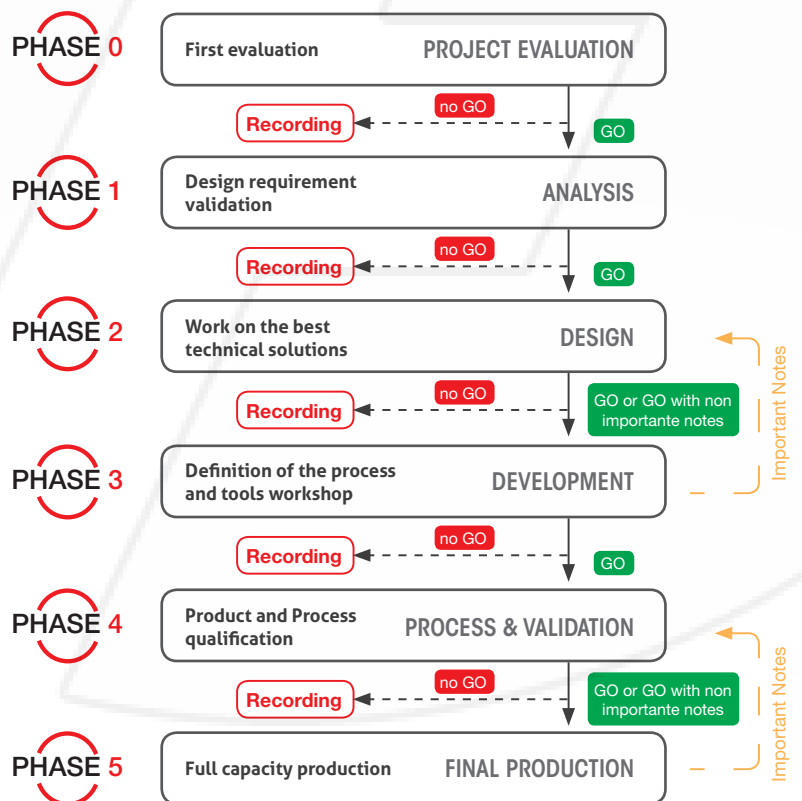

Tel: 01626 201092

www.safi-valves.com

NORMES, DIRECTIVES ET AGRÉMENTS

Standards, directives and approvals

Certifiée ISO 9001:2015, SAFI est leader technique dans le domaine de la robinetterie thermoplastique industrielle.

La qualité ne se résume pas chez SAFI à un simple certificat. C'est une **organisation quotidienne** bien ancrée dans la culture du groupe et structurée par des processus de fonctionnement appliqués.

Ainsi, de façon régulière, nos collaborateurs sont tour à tour audités et auditeurs. Nos processus ISO intègrent des fonctions habituellement exclues du champ d'application de la norme, comme la finance ou l'informatique.

L'ensemble du fonctionnement de l'entreprise est ainsi tourné vers un unique objectif : la satisfaction de nos clients internes et externes et des parties prenantes à l'entreprise.

Membres des comités de normalisation, nous appliquons avec attention les **directives et normes en vigueur** dans la conception, la production et le contrôle des robinets plastiques et de leurs accessoires. Nous avons également défini nos **propres standards**, bien plus restrictifs que les normes actuelles. Ainsi, par exemple, **100% des robinets fabriqués par SAFI sont testés en étanchéité.**

ISO 9001:2015 certified, SAFI is a technical leader in the field of industrial thermoplastic valves.

Quality is not considered as just a certificate. It is a **daily organization** well integrated in the group culture, which is structured by process carefully applied.

Thus, all year long, our teams are audited and then auditors. Our ISO process include some functions which are usually excluded from this standard, such as IT or financial departments.







All the company is then polarized towards a single objective: to satisfy our external and internal customers and the relevant stakeholders.

As a member of the standards working groups, we apply carefully the relevant **standards and directives in the design**, production and control of plastic valves and their accessories.

We also defined our own standards, which are more stringent than the existing ones. As an example, we test the tightness of **100% of the valves manufactured by SAFI.**

Certains de nos robinets répondent à des agréments spécifiques que vous retrouverez dans les pages du catalogue avec les pictogrammes suivants :

Some of our valves comply with specific approvals. You will find them in the catalogue with the following pictograms:

Picto.	DÉSIGNATION	Description
	Adaptation de produits non-métalliques pour l'utilisation en contact avec l'eau potable pour la consommation humaine en considérant leurs effets sur la qualité de l'eau. Méthodes d'essai. Essai de croissance des micro-organismes aquatiques (Agrément WRAS).	Suitability of non-metallic products for use in contact with water intended for human consumption with regard to their effect on the quality of water. Methods of test. Growth of aquatic micro-organisms test (WRAS Approval).
	Produits disposant d'une attestation de conformité sanitaire (ACS) conformément à l'arrêté du 29/05/97 modifié et à la circulaire DGS/SD7A 2002 N° 571 du 25/11/2002.	Products with a certificate of sanitary compliance in accordance with decree of 29/05/97 and circular DGS/SD7A 2002 N° 571 done on 25/11/2002.
	Norme NSF/ANSI 61 « Drinking water systems components Health effects » (effets sur la santé des composants de circuits d'eau potable). La norme NSF/ANSI Standard 61 établit les exigences minimales quant aux effets sur la santé dus au contact des matériaux, des composants, des produits ou des systèmes avec l'eau potable, ainsi que des produits chimiques servant au traitement de cette eau.	Standard NSF/ANSI 61 « Drinking water systems components - Health effects » (health effects of drinking water circuit components). NSF / ANSI Standard 61 establishes minimum health effects requirements for the chemical contaminants and impurities that are indirectly imparted to drinking water from products, components, and materials used in drinking water systems.
	Produits conformes au règlement européen n° 1935/2004 du 27/10/2004 concernant les matériaux et objets destinés à entrer en contact avec les denrées alimentaires.	Products complying with the requirements of European regulation 1935/2004 of 27th of October 2004 relating to materials and articles intended to come into contact with food.
	Produits agréés BV Marine pour une classification « Steel Ships », « Yachts », et « Offshore Units ».	Products approved by BV Marine for « Steel Ships », « Yachts », and « Offshore Units ».
	Produits conformes à la norme ISO 15848-1 (classe B) et à la norme allemande TA-Luft VDI 2440, qui spécifient les critères de fuites externes des dispositifs d'étanchéité.	Products complying with the requirements of EN ISO Standard 15848-1 (Class B) and German standard TA-Luft VDI 2440, which define external leak criteria for leaktight systems.



La qualité, une culture d'entreprise Quality, a corporate culture

+50 Normes et directives

applicables aux robinets plastiques

... et de nombreuses autres applicables aux composants, matières et accessoires.

Les principales directives et normes que nous appliquons sont disponibles dans le tableau ci-dessous.

+50 Directives and standards

applicable to plastic valves

... and many others applicable to components, materials and accessories..

The main directives and standards that we apply are available in the table below.

Référence	DÉSIGNATION	Description
ANSI/ASME B16.10	Dimensions face à face et bout à bout des robinets	Face-to-face and end-to-end dimensions of the valves
ANSI/ASME B16.5	Brides de tuyaux et raccord à brides - NPS 1/2 à NPS 24 normes métrique/inch	Pipe Flanges and Flanged Fittings — NPS 1/2 Through NPS 24 Metric/Inch Standard
API 598	Inspection et test des robinets	Valve Inspection and Testing
BS 6920:2014	Adaptation de produits non-metalliques pour l'utilisation en contact avec l'eau potable pour la consommation humaine en considérant leurs effets sur la qualité de l'eau. Méthodes d'essai. Essai de croissance des micro-organismes aquatiques (Agrément WRAS)	Suitability of non-metallic products for use in contact with water intended for human consumption with regard to their effect on the quality of water. Methods of test. Growth of aquatic micro-organisms test (WRAS Approval)
Circulaire DGS/SD7A N°571	Circulaire relative aux modalités de vérification de la conformité sanitaire des matériaux constitutifs d'accessoires ou de sous-ensembles d'accessoires, constitués d'éléments organiques entrant au contact d'eau destinée à la consommation humaine (Agrément ACS)	Products with a certificate of sanitary compliance in accordance with decree of 29/05/97 and circular DGS/SD7A 2002 N° 571 done on 25/11/2002
Directive 10/2011	Matériaux et objets en matières plastiques destinés à entrer en contact avec des denrées alimentaires	Plastic materials and articles intended to come into contact with food (Food Grade)
Directive 1935/2004	Matériaux et objets destinés à entrer en contact avec des denrées alimentaires et abrogeant les directives 80/590/CEE et 89/109/CEE	Materials and articles intended to come into contact with food and repealing Directives 80/590/EEC and 89/109/EEC (Food Grade)
Directive 2006/42/EC	Directive relative aux machines et modifiant la directive 95/16/CE	Directive on machinery, and amending Directive 95/16/EC
Directive 2014/30/EU	Compatibilité électromagnétique	Electromagnetic compatibility
Directive 2014/34/UE	Appareils et systèmes de protection destinés à être utilisés en atmosphères explosibles (ATEX)	Equipment and protective systems intended for use in potentially explosive atmospheres (ATEX)

Référence	DÉSIGNATION	Description
Directive 2014/35/EU	Mise à disposition sur le marché du matériel électrique destiné à être employé dans certaines limites de tension	The making available on the market of electrical equipment designed for use within certain voltage limits
Directive 2014/68/UE	Mise à disposition sur le marché des équipements sous pression (DESP)	The making available on the market of pressure equipment (PED)
EN 1092-1	Brides et leurs assemblages — Brides circulaires pour tubes, appareils de robinetterie, raccords et accessoires désignées PN — Partie 1 : Brides en acier	Flanges and their joints — Circular flanges for pipes, valves, fittings and accessories PN designated — Part 1: Steel flanges
EN 12266-1	Robinerie industrielle — Essais des appareils de robinetterie métalliques — Partie 1 : Essais sous pression, procédures d'essai et critères d'acceptation — Prescriptions obligatoires	Industrial valves — Testing of metallic valves — Part 1: Pressure tests, test procedures and acceptance criteria — Mandatory requirements
EN 12266-2	Robinerie industrielle — Essais des appareils de robinetterie métalliques — Partie 2 : Essais, modes opératoires d'essai et critères d'acceptation — Prescriptions complémentaires	Industrial valves — Testing of metallic valves — Part 2: Tests, test procedures and acceptance criteria — Supplementary requirements
EN 12560-1	Brides et leurs assemblages — Joints pour les brides désignées Class — Partie 1: joints plats non métalliques avec ou sans insert	Flanges and their joints — Gaskets for Class-designated flanges — Part 1: Non-metallic flat gaskets with or without inserts
EN 12570	Robinerie industrielle — Méthode de dimensionnement de l'organe de manœuvre	Industrial valves — Method for sizing the operating element
EN 1267	Robinerie industrielle — Essai de résistance à l'écoulement utilisant l'eau comme fluide d'essai	Industrial valves — Test of flow resistance using water as test fluid
EN 14420-7	Raccords pour flexibles avec demi-coquille — Partie 7 : Raccords à cames	Hose fittings with clamp units — Part 7: Cam locking couplings
EN 14432	Citernes de transport de matières dangereuses — Équipements de la citerne pour le transport de produits chimiques liquides et de gaz liquéfiés — Vannes de mise en pression de la citerne ou de déchargement du produit	Tanks for the transport of dangerous goods — Tank equipment for the transport of liquid chemicals and liquefied gases — Product discharge and air inlet valves
EN 1514-1	Brides et leurs assemblages — Dimensions des joints pour les brides désignées PN — Partie 1 : joints plats non-métalliques avec ou sans insert	Flanges and their joints — Dimensions of gaskets for PN-designated flanges — Part 1: Non-metallic flat gaskets with or without inserts
EN 558 + A1	Robinerie industrielle — Dimensions face-à-face et face-à-axe — Appareils de robinetterie désignés PN et Class	Industrial valves — Face-to-face and centre-to-face dimensions of metal valves for use in flanged pipe systems — PN and Class designated valves
EN 60529	Degrés de protection procurés par les enveloppes (Code IP)	Degrees of protection provided by enclosures (IP code)
EN 60534-6-1	Vannes de régulation des processus industriels — Partie 6: Détails d'assemblage pour le montage des positionneurs sur les actionneurs de vannes de régulation — Section 1: Montage des positionneurs sur les actionneurs linéaires	Industrial-process control valves — Part 6: Mounting details for attachment of positioners to control valves — Section 1: Positioner mounting on linear actuators
EN 60534-6-2	Vannes de régulation des processus industriels — Partie 6-2: Détails d'assemblage pour le montage des positionneurs sur les actionneurs de vannes de régulation — Montage des positionneurs sur les actionneurs rotatifs	Industrial-process control valves — Part 6-2: Mounting details for attachment of positioners to control valves — Positioner mounting on rotary actuators
EN 736-1	Appareils de robinetterie — Terminologie — Partie 1: Définition des types d'appareil	Valves — Terminology — Part 1: Definition of types of valves
EN 736-2	Appareils de robinetterie — Terminologie — Partie 2: Définition des composants des appareils de robinetterie	Valves — Terminology — Part 2: Definition of components of valves
EN 736-3	Appareils de robinetterie — Terminologie — Partie 3: Définition des termes	Valves — Terminology — Part 3: Definition of terms
IEC 60068-2-17	Essais fondamentaux climatiques et de robustesse mécanique — Partie 2-17: Essais — Essai Q: Étanchéité	Basic environmental testing procedures — Part 2-17: Tests — Test Q: Sealing
IEC 60068-2-6	Essais d'environnement — Partie 2-6: Essais — Essai Fc: Vibrations (sinusoïdales)	Environmental testing — Part 2-6: Tests — Test Fc: Vibration (sinusoidal)
IEC 61000-6-2	Compatibilité électromagnétique (CEM) — Partie 6-2: Normes génériques — Norme d'immunité pour les environnements industriels	Electromagnetic compatibility (EMC) — Part 6-2: Generic standards — Immunity standard for industrial environments
IEC 61000-6-4	Compatibilité électromagnétique (CEM) — Partie 6-4: Normes génériques — Norme sur l'émission pour les environnements industriels	Electromagnetic compatibility (EMC) — Part 6-4: Generic standards — Emission standard for industrial environments
ISO 10931	Systèmes de canalisations en matières plastiques pour les applications industrielles — Poly(fluorure de vinylidène) (PVDF) — Spécifications pour les composants et le système	Plastics piping systems for industrial applications — Poly(vinylidene fluoride) (PVDF) — Specifications for components and the system
ISO 12162	Matières thermoplastiques pour tubes et raccords pour applications avec pression — Classification, désignation et coefficient de calcul	Thermoplastic materials for pipes and fittings for pressure applications — Classification, designation and design coefficient
ISO 12944-2	Peintures et vernis — Anticorrosion des structures en acier par systèmes de peinture — Partie 2 : Classification des environnements	Paints and varnishes — Corrosion protection of steel structures by protective paint systems — Part 2 : Classification of environments
ISO 15493	Systèmes de canalisations en matières plastiques pour les applications industrielles — Acrylonitrile-butadiène-styrène (ABS), poly(chlorure de vinyle) non plastifié (PVC-U) et poly(chlorure de vinyle) chloré (PVC-C) — Spécifications pour les composants et le système — Série métrique	Plastics piping systems for industrial applications — Acrylonitrile-butadiene-styrene (ABS), unplasticized poly(vinyl chloride) (PVC-U) and chlorinated poly(vinyl chloride) (PVC-C) — Specifications for components and the system — Metric series

Référence	DÉSIGNATION	Description
ISO 15494	Systèmes de canalisations en matières plastiques pour les applications industrielles — Polybutène (PB), polyéthylène (PE), polyéthylène de meilleure résistance à la température (PE-RT), polyéthylène réticulé (PEX), polypropylène (PP) — Séries métriques pour les spécifications pour les composants et le système	Plastics piping systems for industrial applications — Polybutene (PB), polyethylene (PE), polyethylene of raised temperature resistance (PERT), crosslinked polyethylene (PE-X), polypropylene (PP) — Metric series for specifications for components and the system
ISO 15848-1	Robinetterie industrielle — Mesurage, essais et modes opératoires de qualification pour émissions fugitives — Partie 1: Système de classification et modes opératoires de qualification pour les essais de type des appareils de robinetterie	Industrial valves — Measurement, test and qualification procedures for fugitive emissions — Part 1: Classification system and qualification procedures for type testing of valves
ISO 16135	Robinetterie industrielle — Robinets à tournant sphérique en matériaux thermoplastiques	Industrial valves — Ball valves of thermoplastic materials
ISO 16136	Robinetterie industrielle — Robinets à papillon en matériaux thermoplastiques	Industrial valves — Butterfly valves of thermoplastics materials
ISO 16137	Robinetterie industrielle — Clapets de non-retour en matériaux thermoplastiques	Industrial valves — Check valves of thermoplastics materials
ISO 16138	Robinetterie industrielle — Robinets à membrane en matériaux thermoplastiques	Industrial valves — Diaphragm valves of thermoplastics materials
ISO 16139	Robinetterie industrielle — Robinets-vannes en matériaux thermoplastiques	Industrial valves — Gate valves of thermoplastics materials
ISO 27895	Technique du vide — Vannes à vide — Essai d'étanchéité des vannes à vide	Vacuum technology — Valves — Leak test
ISO 5210	Robinetterie industrielle — Raccordement des actionneurs multi-tours aux appareils de robinetterie	Industrial valves — Multi-turn valve actuator attachments
ISO 5211	Robinetterie industrielle — Raccordement des actionneurs à fraction de tour	Industrial valves — Part-turn actuator attachments
ISO 7483	Dimensions des joints à utiliser avec les brides de l'ISO 7005	Dimensions of gaskets for use with flanges to ISO 7005
ISO 8233	Robinets en matériaux thermoplastiques — Couple de manœuvre — Méthode d'essai	Thermoplastic valves — Torque — Test method
ISO 8659	Robinets en matériaux thermoplastiques — Résistance à la fatigue — Méthode d'essai	Thermoplastic valves — Fatigue strength — Test method
ISO 9393-1	Robinets en matières thermoplastiques pour les applications industrielles — Méthodes d'essai de pression et exigences — Partie 1: Généralités	Thermoplastic valves for industrial applications — Pressure test methods and requirements — Part 1: General
ISO 9393-2	Robinets en matières thermoplastiques pour les applications industrielles — Méthodes d'essai de pression et exigences — Partie 2: Conditions d'essai et exigences de base	Thermoplastic valves for industrial applications — Pressure test methods and requirements — Part 2: Test conditions and basic requirements
ISO/TR 10358	Tubes et raccords en matières plastiques — Tableau de classification de la résistance chimique	Plastics pipes and fittings — Combined chemical-resistance classification table
NR320	Système de certification des matériaux et équipements pour la classification des unités marines	Certification scheme of materials and equipment for the classification of marine units

MATIÈRES THERMOPLASTIQUES

Thermoplastic Materials

Des matériaux différents en fonction de votre application

SAFI fabrique ses robinets dans une **large gamme de matières**. En fonction des caractéristiques du fluide véhiculé (pression, température, composition chimique) et de l'environnement extérieur (température, présence de rayons UV, ...), **il convient de choisir avec attention les matériaux du robinet**.

Different materials depending on your application

SAFI manufactures its products in a **wide range of materials**. Depending on the characteristics of the fluid (pressure, temperature, chemical composition) and on the external environment (temperature, UV rays, ...), **it is important to choose carefully the materials of the valve**.

	PROPRIÉTÉS	Properties	TEMPÉRATURE	PN*
PVC-U	<p>Le PVC-U (non plastifié) est un des matériaux plastiques les plus anciens et les plus utilisés dans l'industrie ou les produits grand public. Ce thermoplastique amorphe ne réagit pas à l'humidité et est très stable dimensionnellement à température ambiante.</p> <p>Sa bonne tenue chimique à température modérée (0-60°C) ainsi que son faible coût en font le matériau le plus répandu dans la robinetterie et la tuyauterie plastique.</p> <p>Ce matériau, qui se colle et se soude, présente cependant une faible résistance aux chocs et ne tient pas aux UV, ce qui limite son utilisation dans de nombreuses applications. Il en est de même pour sa tenue thermique modérée et on lui préférera alors le PVC-C.</p>	<p>The PVC-U (unplasticised) is one of the oldest and the most used plastic materials in the industry and in consumer products. This amorphous thermoplastic does not react to humidity and is dimensionally very stable at room temperature.</p> <p>This material is the most widely used in the valve industry and plastic piping, thanks to its good chemical behaviour at moderate temperature (0-60°C) and its low cost.</p> <p>This material, which can be glued and welded, presents however a low shock resistance and cannot withstand UV light, which limits its use in various applications. It is the same for its moderate thermal behaviour and we would rather use PVC-C.</p>	0°C → 60°C	PN 16
PVC-C	<p>Le PVC surchloré (PVC-C), outre sa densité supérieure, présente une plus grande plage de tenue thermique (jusqu'à 90°C environ) que le PVC-U. La présence de chlore dans le PVC-C rend néanmoins son utilisation de plus en plus contestée. Il est dans ce cas souvent remplacé par l'ABS ou le PP.</p>	<p>Chlorinated polyvinyl chloride (PVC-C) with its superior density presents a greater range of thermal behaviour (up to approximately 90°C) than PVC-U. Because of the presence of chlorine in the PVC-C, its use is more and more contested. In this case, it is often replaced by ABS or PP.</p>	0°C → 90°C	PN 16
PP-H	<p>Le polypropylène (PP) est un thermoplastique semi-cristallin, du groupe des polyoléfinés. Ses bonnes propriétés mécaniques et chimiques en font un des matériaux les plus répandus dans la robinetterie plastique.</p> <p>On compte trois grandes familles de polypropylène :</p> <ul style="list-style-type: none"> . Type 1 : PP-H (Homopolymère) . Type 2 : PP-B (Block-copolymère) . Type 3 : PP-R (Random-copolymère) <p>Les robinets SAFI utilisent exclusivement le PP de Type 1.</p> <p>Le polypropylène présente une bonne stabilité thermique (par rapport au PVC-U notamment) entre 0°C et +90°C, ainsi qu'une bonne résistance aux chocs. La nature non polarisée du PP lui donne une bonne résistance chimique.</p> <p>Il résiste notamment aux sels, acides et alcalis et à de nombreux solvants organiques. Le polypropylène est non-toxique et se soude facilement.</p>	<p>Polypropylene (PP) is a thermoplastic partially crystalline, from the polyolefin group. Due to its good mechanical and chemical properties, it is one of the most widely used materials in the plastic valve industry.</p> <p>There are three main polypropylene families:</p> <ul style="list-style-type: none"> . Type 1: PP-H (Homopolymer) . Type 2: PP-B (Block-copolymer) . Type 3: PP-R (Random-copolymer) <p>SAFI's valves exclusively use Type 1 PP.</p> <p>The polypropylene presents a good thermal stability from 0°C up to 90°C (particularly compared to PVC-U), as well as a good shock resistance. PP's non-polarized nature provides a good chemical resistance.</p> <p>It particularly resists to salts, acids and alkalis and numerous organic solvents. The polypropylene is non-toxic and can be easily welded.</p>	0°C → 90°C	PN 10

*typique du robinet DN ≤ 50
Typical PN of the valve DN ≤ 50

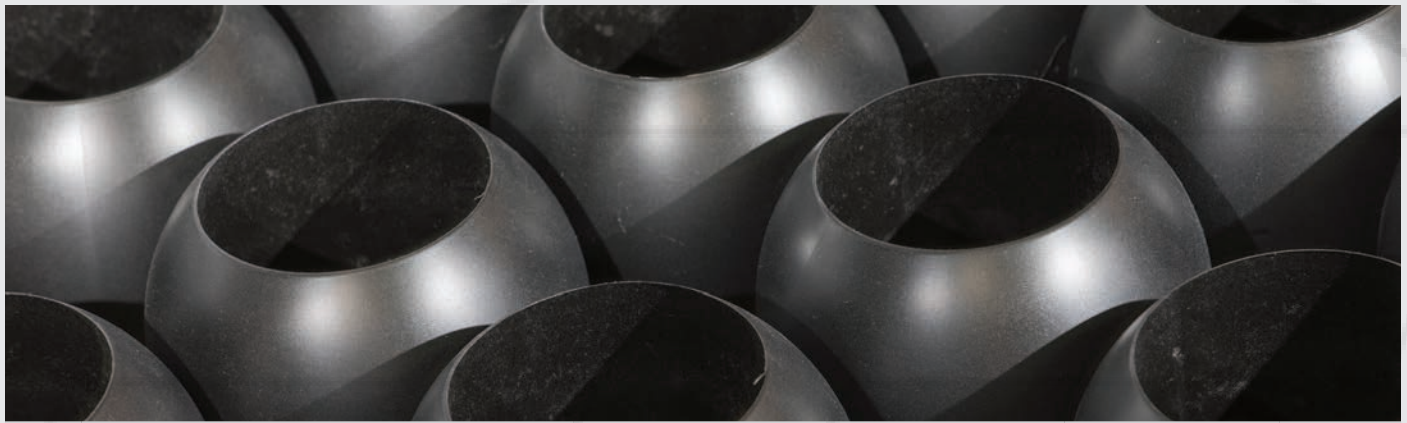

	PROPRIÉTÉS	Properties	TEMPÉRATURE	PN*
PPGF	<p>Ce polypropylène contient 20 % de fibres de verre borosilicates de type «C» résistantes chimiquement.</p> <p>Il possède une très bonne résistance mécanique, une grande stabilité dimensionnelle, s'usine facilement et résiste à des températures de -10°C jusqu'à 100°C.</p> <p>Sa résistance aux UV est améliorée par l'ajout de pigments au carbone et de stabilisateurs aux UV.</p>	<p>This polypropylene contains 20 % of borosilicate glass reinforced of type «C» chemically resistant.</p> <p>It has a very good mechanical resistance, a good dimensional stability, can be easily machined and it is resistant to temperatures from -10 up to 100°C.</p> <p>Its resistance to UV is improved by the addition of carbon pigments and UV stabilizers.</p>	-10°C → 100°C	PN 10
PP-EL	<p>Ce polypropylène contient 20% de fibres de carbone.</p> <p>Il possède ainsi une résistivité superficielle fortement diminuée ($10^5 \Omega$) par rapport au PP standard (minimum $10^{17} \Omega$) lui permettant de mieux conduire l'électricité tout en préservant ses autres propriétés.</p> <p>Il permet à toute une gamme de produits SAFI d'être compatible avec la réglementation ATEX zones 1 et 2.</p>	<p>This polypropylene contains 20% of carbon fibres.</p> <p>Thus, its surface resistivity ($10^5 \Omega$) is significantly reduced compared to standard PP (minimum $10^{17} \Omega$), so it can better conduct electricity while keeping its other properties.</p> <p>It enables a whole range of SAFI valves to comply with zones 1 and 2 ATEX regulation.</p>	0°C → 90°C	PN 10
PVDF	<p>Le polyfluorure de vinylidène est un thermoplastique très résistant mécaniquement et chimiquement. À l'instar des autres polymères fluorés, il supporte les variations de température (-20°C à +120°C), les ultraviolets et les agents chimiques les plus corrosifs. Le PVDF est un homopolymère sans additifs, non toxique. Il a une surface particulièrement lisse, qui évite le développement de micro-organismes.</p> <p>SAFI a sélectionné un grade hautement cristallin de PVDF présentant une très bonne résistance mécanique, ainsi qu'une grande stabilité à long terme à haute température. Ce grade présente de plus une bonne résistance au chlore humide.</p> <p>Les avantages principaux du PVDF sont les suivants :</p> <ol style="list-style-type: none"> 1. Grande résistance chimique, 2. Plage de tenue thermique, 3. Résistance à l'abrasion, 4. Stabilité à haute température, 5. Facilité de soudure, 6. Résistant aux UV, 7. Bons états de surface. 	<p>PolyVinylidene fluoride has an excellent chemical and physical resistance. Such as other fluorinated polymers, it supports temperature variations from -20°C up to +120°C, ultra-violets and the most corrosive chemical agents. The PVDF is a homopolymer without additives, non-toxic, has a particularly smooth surface, which avoids the development of micro-organisms.</p> <p>SAFI has selected a highly crystalline grade of PVDF, with a strong mechanical resistance and an excellent long term stability at high temperature. This grade has particularly good resistance in wet chlorine applications.</p> <p>The main advantages of PVDF are:</p> <ol style="list-style-type: none"> 1. High chemical resistance, 2. Temperature range (-20°C up to 120°C), 3. Abrasion resistance, 4. High temperature stability, 5. Welded easily, 6. UV resistance, 7. Smooth finish surface. 	-20°C → 120°C	PN 16
PE-HD	<p>Le polyéthylène (PE) est un polymère thermoplastique avec diverses structures cristallines qui offrent une large gamme de propriétés mécaniques. Le polyéthylène possède une bonne résistance aux chocs et il supporte les agents chimiques et les ultraviolets. Ce matériau se soude facilement et peut être utilisé à des températures très basses jusqu'à -40°C. Par contre, sa résistance mécanique (inférieure à celle du polypropylène) diminue rapidement lorsque la température augmente.</p> <p>Il existe diverses applications pour le polyéthylène pour lesquelles certains grades sont plus ou moins adaptés. SAFI a sélectionné le PE-HD dans ses produits. Le polyéthylène haute densité a une structure cristalline élevée et offre une excellente résistance aux chocs, une faible absorption d'humidité et une bonne résistance à la traction.</p>	<p>Polyethylene (PE) is a thermoplastic polymer with various crystalline structures which results in a wide range of properties. Polyethylene has a good impact strength (shock resistance), good chemical and UV resistance. This material can be easily welded and used at very low temperatures down to -40°C. On the other hand, its mechanical strength, lower than the one of polypropylene, decreases rapidly when temperature increases.</p> <p>There are various applications for polyethylene in which certain types are more or less well suited. SAFI has selected PE-HD in its products. High density polyethylene has a high crystalline structure and offers excellent impact strength, low moisture absorption and a good tensile strength.</p>	-40°C → 70°C	PN 10

*typique du robinet DN ≤ 50
Typical PN of the valve DN ≤ 50

MATIÈRES ELASTOMÈRES

Elastomer Materials

Les élastomères, clés de l'étanchéité du robinet thermoplastique

La fiabilité et la durée de vie d'un robinet sont conditionnées par le choix du bon élastomère en fonction des contraintes chimiques, thermiques et mécaniques.

SAFI sélectionne des grades de haute qualité pouvant garder leurs propriétés dimensionnelles et élastiques sur de très longues périodes, malgré une utilisation intensive, des températures extrêmes ou des fluides agressifs.

Elastomers, keys of the tightness of thermoplastic valves

The reliability and the life of a valve are conditioned by the choice of the right elastomer according to the chemical, thermal and mechanical constraints.

SAFI selects high quality grades that keep their dimensional and elastic properties over very long periods, despite intensive use, extreme temperatures or aggressive fluids.

	PROPRIÉTÉS	Properties	TEMPÉRATURE
EPDM	<p>EPDM (Éthylène-Propylène-Diène Monomère)</p> <p>L'EPDM a des caractéristiques mécaniques excellentes. Il a une très bonne résistance à la température et au vieillissement. Sa résistance chimique est bonne et orientée sur les produits basiques et les acides dilués. Il ne résiste pas aux huiles minérales et d'une manière générale aux hydrocarbures.</p>	<p>EPDM (Ethylene Propylene Diene Monomer)</p> <p>EPDM has excellent mechanical characteristics, and excellent resistance to both temperature and ageing. Its chemical resistance is also good, particularly concerning bases and diluted acids. However, it doesn't resist mineral oils or hydrocarbons in general.</p>	-40°C → 160°C
EPDM A	<p>EPDM Alimentaire (Éthylène-Propylène-Diène Monomère)</p> <p>Nous proposons certains robinets équipés de joints EPDM «alimentaires». Ces derniers sont conformes à la réglementation (UE) No 10/2011 de la commission du 14 janvier 2011 concernant les matériaux et objets en matière plastique destinés à entrer en contact avec des denrées alimentaires.</p>	<p>Food quality EPDM (Ethylene Propylene Diene Monomer)</p> <p>We offer certain assemblies equipped with food-quality EPDM seals compliant with EU regulation No. 10/2011, issued by the Commission on 14th January 2011, relating to plastic materials and objects likely to be in contact with foodstuffs.</p>	-40°C → 160°C
FPM	<p>FPM ou FKM (élastomère fluoré de type Viton®)</p> <p>Elaboré à partir de la polymérisation de plusieurs produits fluorés (notamment du fluorure de vinylidène), le FPM a une très bonne tenue aux fluides agressifs et aux hautes températures. En contrepartie, sa tenue au froid est limitée. SAFI a choisi un mélange particulièrement orienté vers la résistance aux acides forts (taux de fluor : 70 %) tout en conservant sa résistance traditionnelle aux huiles minérales et aux hydrocarbures.</p>	<p>FKM or FPM (fluoro elastomer like Viton®)</p> <p>FPM is prepared by polymerising several fluorinated substances (notably vinylidene fluoride) and offers excellent resistance to both corrosive fluids and high temperatures. Conversely, its cold resistance is somewhat limited. SAFI has adopted a mixture that is particularly aimed at resisting concentrated acids (fluorine content: 70 %), while retaining its original resistance to mineral oils and hydrocarbons.</p>	-5°C → 200°C
FFPM	<p>FFPM ou FFKM (élastomère perfluoré de type Dynalast® ou Kalrez®)</p> <p>Grâce à sa base constituée de monomères fluorés, le FFPM offre d'excellentes performances dans les environnements agressifs, comme les acides, amines, plasmas, eau ultra-pure dionisée ou les bases fortes. Il a une résistance extrême au gonflement sur une grande variété de produits chimiques et solvants, comme l'acide nitrique, l'hydroxyde de sodium ou l'éthylènediamine.</p>	<p>FFPM or FFKM (perfluoroelastomer like Dynalast® or Kalrez®)</p> <p>FFPM is based on fluorinated monomers. It delivers outstanding performance in aggressive process environments, such as acids, amines, plasma, ultrapure de-ionized water or strong bases. It can resist extreme volume swell when exposed to a wide variety of chemicals and solvents, including concentrated nitric acid, sodium hydroxide or ethylene diamine.</p>	-5°C → 300°C
PTFE/FEP	<p>PTFE (Poly Tétra Fluoro Ethylène) FEP (Fluor Ethylène Propylène)</p> <p>SAFI utilise des membranes en PTFE et des joints revêtus FEP (copolymère injectable équivalent au PTFE). Le joint torique FEP est composé d'un noyau élastomère silicone enrobé d'une enveloppe étanche en FEP ; il a la résistance chimique du PTFE. FEP et PTFE sont utilisés en pharmacie et alimentaire grâce à leur caractère physiologiquement neutre.</p>	<p>PTFE (Poly Tetra Fluoro Ethylene) FEP (Fluorinated Ethylene Propylene)</p> <p>SAFI uses PTFE diaphragm and FEP (injectable copolymer equivalent to PTFE) coated seals. The FEP o-ring comprises a silicone elastomer core coated with an FEP seal envelope, offering the chemical resistance of PTFE. FEP and PTFE are used in the pharmaceutical and foodstuffs industries, due to their physiologically neutral characteristics.</p>	-60°C → 200°C



quotes@tfpes.co.uk

CAHIER TECHNIQUE
Technical Notebook

TECH

Tel: 01626 201092

15

www.safi-valves.com

RACCORDS

Fittings

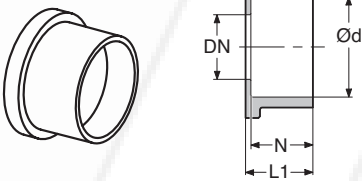
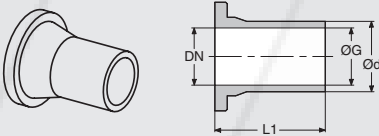
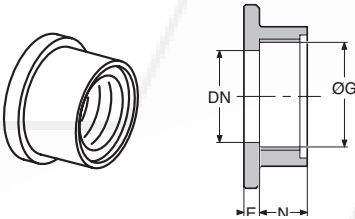
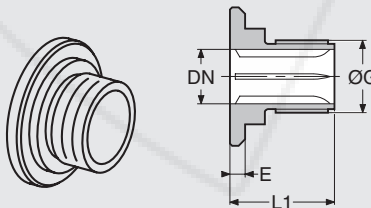

TYPE Type of connection	SCHÉMA DE L'EMBOUT - VUE 3D Drawing - 3D view	COMMENTAIRE	Comment
Embout femelle Plain socket		<p>Disponibles en norme à coller (PVC-C, PVC-U, ABS) : DIN 8063 / ISO 15493 (DIN), BS 4346 (BS), ASTM D2467 (SCH80) à souder (PP-H, PVDF, PE100) : DIN 16962 / ISO 15494</p> <p>nos embouts femelles se montent sur des robinets à unions et sont disponibles dans de nombreuses matières.</p>	<p>Available in the following standards to be glued (PVC-C, PVC-U, ABS) : DIN 8063 / ISO 15493 (DIN), BS 4346 (BS), ASTM D2467 (SCH80) to be welded (PP-H, PVDF, PE100) : DIN 16962 / ISO 15494</p> <p>our plain sockets can be mounted on union valves. They are available in many different materials.</p>
Embout mâle Plain spigot		<p>Disponibles en norme : ISO 15494 & NF EN 12201 (PE100) ISO 10931 (PVDF) ISO 15494 & DIN 16962 (PP-H), nos embouts mâles font directement partie du corps de certains robinets ou se montent sur des versions à unions.</p>	<p>Available in the following standards ISO 15494 & NF EN 12201 (PE100) ISO 10931 (PVDF) ISO 15494 & DIN 16962 (PP-H), our plain spigot are integrated in the body of some valves or can be mounted on union valves.</p>
Embout taraudé Threaded socket		<p>Disponibles en pas du gaz cylindrique (BSP) ou NPT, nos embouts taraudés se montent sur des robinets à unions.</p>	<p>Available with a BSP or NPT thread, our threaded sockets can be mounted on union valves.</p>
Embout fileté Threaded spigot		<p>Disponibles en pas du gaz cylindrique (BSP), nos embouts filetés se montent sur des robinets à unions.</p>	<p>Available with a BSP thread, our threaded spigots can be mounted on union valves.</p>

quotes@tfpes.co.uk

+ 40 raccords et embouts

SAFI propose sur ses robinets différents types de raccords à la tuyauterie. Les principaux types de connexion sont détaillés ci-dessous.

La liste exhaustive des embouts possibles se trouve dans l'onglet «Fittings» du catalogue.

+ 40 fittings and couplings

SAFI offers on its valves different types of fittings. The main types of fittings are detailed below.

The detailed list of all available fittings can be found in the chapter «Fittings» of this catalogue.

TYPE Type of connection	SCHÉMA DE L'EMBOUT - VUE 3D Drawing - 3D view	COMMENTAIRE	Comment
A bride With flange		Directement intégrées à nos robinets compacts et sandwiches, nos brides sont également disponibles pour robinets à unions. Suivant les produits, elles existent en norme EN1092-1 (DIN), ASME B16.5 (ANSI), BS ou multinorme.	Directly integrated in our flanged compact valves, our flanges are also available for union valves. Depending on the product, they can be available in EN1092-1 (DIN), ASME B16.5 (ANSI), BS or for the 3 standards.
Pour tuyau souple Hosetail		Disponible en PPGF très résistant mécaniquement, nos embouts pour tuyau souple se montent sur des robinets à unions.	Made in PPGF which has a strong mechanical resistance, our hosetails are mounted on union valves.
Camlock Camlock		Disponible en PPGF très résistant mécaniquement, nos embouts camlock se montent sur des robinets à unions.	Made in PPGF which has a strong mechanical resistance, our camlocks are mounted on union valves.
Robinet double union avec écrous et joints, sans embouts Double union valve with union nuts and o-rings, without sockets		Certains de nos robinets à unions sont proposés avec écrous et joints d'étanchéité à l'embout, mais sans embout. Ces derniers doivent alors être achetés séparément.	Some of our union valves are offered with union nuts and o-rings, but without any connection. The requested connection has to be purchased separately.

DIMENSIONS DES BRIDES

Flanges dimensions

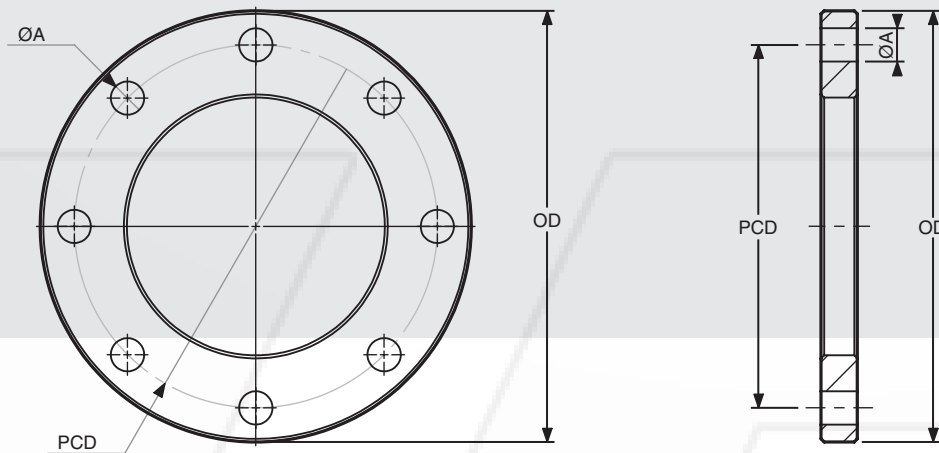

DIMENSIONS Dimensions	EN 1092-1 PN10 («DIN»)				ASME B16.5 Class 150 («ANSI» EN 1759 Class 150)				BS10 Table D («BS»)			
	OD	PCD	ØA	Nb/Nbr A	OD	PCD	ØA	Nb/Nbr A	OD	PCD	ØA	Nb/Nbr A
mm	mm	mm	mm		mm inch.	mm inch.	mm inch.		mm inch.	mm inch.	mm inch.	
15 1/2"	95	65	14	4	90 3" 1/2	60,3 2" 3/8	15,9 5/8"	4	95,3 3" 3/4	66,7 2" 5/8	14,3 9/16	4
20 3/4"	105	75	14	4	100 3" 7/8	69,9 2" 3/4	15,9 5/8"	4	101,6 4"	73 2" 7/8	14,3 9/16	4
25 1"	115	85	14	4	110 4" 1/4	79,4 3" 1/8	15,9 5/8"	4	114,3 4" 1/2	82,6 3" 1/4	14,3 9/16	4
32 1" 1/4	140	100	18	4	115 4" 5/8	88,9 3" 1/2	15,9 5/8"	4	120,7 4" 3/4	87,3 3" 7/16	14,3 9/16	4
40 1" 1/2	150	110	18	4	125 5"	98,4 3" 7/8	15,9 5/8"	4	133,4 5" 1/4	98,4 3" 7/8	14,3 9/16	4
50 2"	165	125	18	4	150 6"	120,7 4" 3/4	19 3/4"	4	152,4 6"	114,3 4" 1/2	17,5 11/16	4
65 2" 1/2	185	145	18	4	180 7"	139,7 5" 1/2	19 3/4"	4	165,1 6" 1/2	127 5"	17,5 11/16	4
80 3"	200	160	18	8	190 7" 1/2	152,4 6"	19 3/4"	4	184,2 7" 1/4	146 5" 3/4	17,5 11/16	4
100 4"	220	180	18	8	230 9"	190,5 7" 1/2	19 3/4"	8	215,9 8" 1/2	177,8 7"	17,5 11/16	4
125 5"	250	210	18	8	255 10"	215,9 8" 1/2	22,2 7/8"	8	254 10"	209,6 8" 1/4	17,5 11/16	8
150 6"	285	240	22	8	280 11"	241,3 9" 1/2	22,2 7/8"	8	279,4 11"	235 9" 1/4	17,5 11/16	8
200 8"	340	295	22	8	345 13" 1/2	298,5 11" 3/4	22,2 7/8"	8	336,6 13" 1/4	292,1 11" 1/2	17,5 11/16	8
250 10"	395	350	22	12	405 16"	362 14" 1/4	25,4 1"	12	406,4 16"	355,6 14"	22,2 7/8	8
300 12"	445	400	22	12	485 19"	431,8 17"	25,4 1"	12	457,2 18"	406,4 16"	22,2 7/8	12
350 14"	505	460	22	16	535 21"	476,3 18" 3/4	28,6 1" 1/8	12	527 20" 3/4	469,9 18" 1/2	25,4 1"	12
400 16"	565	515	22	16	595 23" 1/2	539,8 21" 1/4	28,6 1" 1/8	16	578 22" 3/4	520,7 20" 1/2	25,4 1"	12
450 18"	615	565	26	20	635 25"	577,9 22" 3/4	31,8 1" 1/4	16	641 25" 1/4	584,2 23"	25,4 1"	12
500 20"	670	620	26	20	700 27" 1/2	635 25"	31,8 1" 1/4	20	705 27" 3/4	641,4 25" 1/4	25,4 1"	16
600 24"	780	725	30	20	815 32"	749,3 29" 1/2	34,9 1" 3/8	20	826 32" 1/2	755,6 29" 3/4	28,6 1" 1/8	16

DICTIONNAIRE FRANÇAIS - ANGLAIS

French - English dictionary

FRANÇAIS	English
A	
abrasion	abrasion
acides	acids
acier	steel, carbon steel
acier forgé	forged steel
acier inoxydable	stainless steel
acier moulé	cast steel
actionneur	actuator
aiguille (de manomètre)	(pressure gauge) pointer
aimant	magnet
air comprimé	compressed air
alimentateur automatique	feed regulator
aluminium	aluminium
amiante	asbestos
ammoniaque	ammonia solution
antibélier	air chamber
axe	shaft
B	
bague de fond	packing ring, packing collar
bille	ball
boîtier de fin de course	limit switch box
bonde de fond	bottom drain
bouche d'incendie	fire hydrant
bouchon femelle	cap
bouchon mâle	plug
boulon	bolt
bouillage de presse-étoupe	packing
bras d'articulation	hinge
bride	flange
bride à souder (en bout, à l'intérieur)	welding-neck flange, slip-on welding flange
bride à visser	threaded flange
bride de presse-étoupe	packing gland flange
bronze	bronze
buse	nozzle
butée mécanique réglable	adjustable travel stop
by-pass	by-pass
C	
cadran	dial
calorifuge	heat insulating material
caoutchouc	rubber
carré	square

FRANÇAIS	English
carré (pour clef)	plug square
chanfrein	chamfer
chapeau	bonnet, cap
chute de pression	pressure drop
clapet (de robinet)	disc, plug
clapet crépine	foot check valve
clapet de retenue	check valve
clapet de retenue à battant	swing check valve
clapet de retenue à soupape	lift check valve
clavette	key
clef à tubes	pipe wrench
clef de manœuvre	cock lever, plug valve wrench
collier de fixation (pour tube)	pipe clamp
collier de serrage (pour tuyau)	hose clamp
colmatage	clogging
compteur	meter, counter
conditions de service	operating conditions
contacteur électrique	switch
contre-écrou	lock nut
contrepoids	counterweight
contrôleur de circulation	sight flow indicator, sight glass
contrôleur de niveau	liquid level-controller
contrôleur de pression	pressure controller
corps	body
corrosion	corrosion
coude	elbow
coup de bélier	water hammer
coupelle de ressort	spring plate
coupe-tubes	pipe cutter
croix	cross
cuivre	copper
D	
débit	flow rate
débitmètre	flow meter
déshuileur de vapeur	steam oil separator
détecteur de proximité	inductive sensor, proximity switch
détendeur de pression	pressure regulator/retainer
diamètre (du cercle) de perçage	diameter of bolt circle
diamètre de trou de boulon	diameter of bolt hole
diamètre extérieur	outside diameter
diamètre intérieur	inside diameter

FRANÇAIS	English
dimensions	dimensions
disque (de clapet)	disc
disque de rupture	rupture disc
douille	sleeve, drive
E	
eau	water
échangeur de température	head exchanger
écrou	nut
écrou de presse-étoupe	packing nut
écrou de volant	handwheel retaining nut
écrou d'opercule	spindle nut, disc bushing
éjecteur, élévateur	ejector, exhauster
électrovanne	solenoid valve
enregistreur	recorder
entrée	inlet
essence	gasoline, petrol
étanchéité	tightness
étrier	bracket
F	
filetage	male thread
filetage (extérieur)	external thread
filetage conique	tapered thread
filetage cylindrique	parallel (straight) thread
filtre	strainer, filter
flotteur	float
fluide	fluid
fonte	iron, cast iron
fuite	leakage
G	
gaz	gas
goujon	stud, stud bolt
goupille conique	taper pin
goupille fendue	split pin
grippage	galling
H	
hauteur	height
huile	oil
hydrocarbures	hydrocarbons
hygromètre	hygrometer
I	
indicateur de position	position indicator
indicateur d'ouverture	travel indicator, opening indicator
J	
jauge magnétique	magnetic gauge
jauge pneumatique	pneumatic gauge
joint	gasket

FRANÇAIS	English
joint plat	flat gasket
joint d'expansion	expansion joint
joint torique	O-ring
L	
laiton	brass
levier	lever
liquide	liquid
longueur	length
M	
mamelon	nipple
manchon	coupling
manomètre	pressure gauge
manostat	pressure switch
matériaux	materials
mazout	fuel oil
membrane	diaphragm
membrane d'éclatement	burst diaphragm
mercure	mercury
N	
normalement fermé	fail close, normally close
normalement ouvert	fail to open, normally open
O	
orifice de passage	port size, orifice size
orifices à brides	flanged ends
orifices à souder (en bout, à l'intérieur)	butt-welding ends, socket-welding ends
orifices filetés (mâles)	threaded ends (male)
orifices taraudés (femelles)	threaded ends (female)
P	
perçage	drilling
perte de charge	pressure loss
pétrole	petroleum
pièce de réglage	adjusting nut
pièces détachées	spare parts
piston	piston
plaquette de régulation	regulation plate
plomb	lead
poids	weight
poignée homme mort	dead man handle
polyfuser bout à bout	butt welding
polyfuser par manchonnage	sleeve welding
pompe	pump
potentiomètre	potentiometer
presse-étoupe	packing gland, cable gland
pression	pressure
pression de réglage	set pressure
pression de service	working pressure

FRANÇAIS	English
pression d'épreuve	test pressure
pression nominale	nominal pressure
produits chimiques	chemical products
R	
raccordement	connection
raccords	fittings
rallonge de poignée	handle extension
réchauffeur	heater
réducteur de pression	pressure reducing valve
réducteur manuel à volant	gear box with handwheel
régulateur	regulator
régulateur de débit	flow regulator
régulateur de niveau	liquid level regulator
régulateur de température	temperature controller
ressort	spring
robinet	valve
robinet à boisseau	plug valve
robinet à flotteur	float valve
robinet à manchon	pinch valve
robinet à manœuvre rapide	quick operating valve
robinet à membrane	diaphragm valve
robinet à papillon	butterfly valve
robinet à pointeau (à aiguille)	needle valve
robinet à quatre voies	four-way valve
robinet à siège incliné	angle seat valve, inclined seat valve
robinet à soupape	globe valve
robinet à tournant sphérique	ball valve
robinet à troies voies	three-way valve
robinet de baignoire	bath tap
robinet de contrôle	control valve
robinet de douche	shower tap
robinet de fond de cuve	bottom drain valve
robinet de jauge	gauge valve
robinet de lavabo	sink tap
robinet de radiateur	radiator valve
robinet d'équerre	angle valve
robinet mélangeur	mixer valve
robinet motorisé	actuated valve
rondelle	washer
S	
saumure	brine
séparateur de manomètre	gauge guard
siège	seat, seat ring
sortie	outlet
soufflet	bellow
soufflette à air	air nozzle, air gun

FRANÇAIS	English
soupape de sécurité surpression	pressure relief valve
soupape de sûreté	safety valve, relief valve
soupape de ventilation	air release valve, venting valve
surpression	overpressure
T	
tamis	screen
tarudage (intérieur)	internal thread / female thread
té	tee
température	temperature
tension	voltage
thermomètre	thermometer
thermostat	thermostat
tige / axe	stem, spindle
trou de boulon	bolt hole
trou de dégazage	vent hole
tuyau	pipe
U	
union	union
V	
vacuomètre	vacuum gauge
vanne	gate valve
vapeur	steam
verre	glass
vide	vacuum
vis	screw
vis de réglage	adjusting screw
vis fileté à droite	right-handed screw
vis fileté à gauche	left-handed screw
viscosité	viscosity
vitesse d'écoulement	flow velocity
volant à chaîne	chainwheel
volant à main	handwheel

OPTIONS DES ROBINETS













Valves options

De nombreuses options sont possibles sur nos robinets.

Celles-ci sont représentées dans le catalogue par des pictogrammes dont la signification est détaillée ci-dessous.

Many options are possible on our valves.

These are represented in the catalog by pictograms whose meaning is detailed below.

Picto.	DÉSIGNATION	Description
	Réhausse de commande	Handle extension
	Axe en INOX 316	Shaft in stainless steel 316
	Étanchéité en EPDM	EPDM seals
	Étanchéité en FEP FFPM	FEP FFPM seals
	Possibilité de conformité au règlement européen 1935/2004 (contact avec les denrées alimentaires)	Conformity to European regulation 1935/2004 (contact with food)
	Robinet cadenasable	Lockable valve
	Inserts LUG en INOX 316	LUG inserts in stainless steel 316
	Robinet motorisable	The valve can be actuated
	Produits conformes à la norme ISO 15848-1 (classe B) et à la norme allemande TA-Luft VDI 2440, qui spécifient les critères de fuites externes des dispositifs d'étanchéité.	Products complying with the requirements of EN ISO Standard 15848 (Class B) and German standard TA-Luft VDI 2440, which define external leak criteria for leaktight systems.
	Sphère PVDF	PVDF ball
	Plaquette de régulation	Regulation plate
	Autres options possibles (consulter la fiche produit)	Other types of options are possible (see product sheet)



notes@tfpes.co.uk

NOS PRODUITS
Our products

PRODUCTS

Tel: 01626 201092

23

www.safi-valves.com

quotes@tfpes.co.uk

PVC-U

PVC-U

Tel: 01626 201092

24

www.safi-valves.com



ROBINETTERIE INDUSTRIELLE - Industrial valves

PVC-U

Le PVC-U (non plastifié) est un des matériaux plastiques les plus anciens et les plus utilisés dans l'industrie ou les produits grand public. Ce thermoplastique amorphe ne réagit pas à l'humidité et est très stable dimensionnellement à température ambiante.

Sa bonne tenue chimique à température modérée (0-60°C) ainsi que son faible coût en font le matériau le plus répandu dans la robinetterie et la tuyauterie plastique. Ce matériau, qui se colle et se soude, présente cependant une faible résistance aux chocs et ne tient pas aux UV, ce qui limite son utilisation dans de nombreuses applications. Il en est de même pour sa tenue thermique modérée et on lui préférera alors le PVC-C.

The PVC-U (unplasticised) is one of the oldest and the most used plastic materials in the industry and in consumer products. This amorphous thermoplastic does not react to humidity and is dimensionally very stable at room temperature.

This material is the most widely used material in the valve industry and plastic piping, thanks to its good chemical behaviour at moderate temperature (0-60 °C) and its low cost.

This material, which can be glued and welded, presents however a low shock resistance and cannot withstand UV light, which limits its use in various applications. It is the same for its moderate thermal behaviour and we would rather use PVC-C.

0°C → +60°C

TEMPÉRATURE DE SERVICE
Operating temperature

ROBINET À TOURNANT SPHÉRIQUE

Ball valve

SERIE 3101



N° Fiche produit - Product sheet
TDS-BALL-3101

STANDARDS &
APPROVALS

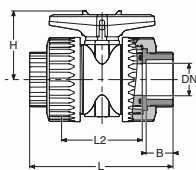

ROBINET PVC-U À TOURNANT SPHÉRIQUE 2 VOIES, DOUBLE UNION, EMBOUTS PVC-U FEMELLES MÉTRIQUES

2-way PVC-U ball valve, double union, PVC-U metric sockets

DIMENSIONS Dimensions							RÉFÉRENCE Product code		
d	DN	G	L	L2	H	B	EPDM	FPM	PN
mm	mm	inch	mm	mm	mm	mm			bar
15	10	3/8"	115	64	48	15	3101-99BBE	3101-99BBV	16
20	15	1/2"	115	64	51	17	3101-00BBE	3101-00BBV	16
25	20	3/4"	126	64	62	18.5	3101-01BBE	3101-01BBV	16
32	25	1"	144	69	69	21	3101-02BBE	3101-02BBV	16
40	32	1 1/4"	183	76.5	85	26	3101-03BBE	3101-03BBV	16
50	40	1 1/2"	183	93	85	35	3101-04BBE	3101-04BBV	16
63	50	2"	202	114	98	38	3101-05BBE	3101-05BBV	16
75	65	2 1/2"	233	116.5	142	45	3101-06BBE	3101-06BBV	10
90	80	3"	274	149	165	51	3101-07BBE	3101-07BBV	10
110	100	4"	325	175	170	61	3101-08BBE	3101-08BBV	10

ROBINET PVC-U À TOURNANT SPHÉRIQUE 2 VOIES, DOUBLE UNION, EMBOUTS PVC-U TARAUDES PAS DU GAZ CYLINDRIQUE

2-way PVC-U ball valve, double union, PVC-U BSP threaded sockets

DIMENSIONS Dimensions							RÉFÉRENCE Product code		
d	DN	G	L	L2	H	B	EPDM	FPM	PN
mm	mm	inch	mm	mm	mm	mm			bar
15	10	3/8"	115	64	48	22.5	3101-99AAE	3101-99AAV	10
20	15	1/2"	115	64	51	22.5	3101-00AAE	3101-00AAV	10
25	20	3/4"	127	64	62	25.5	3101-01AAE	3101-01AAV	10
32	25	1"	145	69	69	29	3101-02AAE	3101-02AAV	10
40	32	1 1/4"	183	76.5	85	35	3101-03AAE	3101-03AAV	10
50	40	1 1/2"	183	93	85	36	3101-04AAE	3101-04AAV	10
63	50	2"	203	114	98	38	3101-05AAE	3101-05AAV	10
75	65	2 1/2"	230	116.5	142	45	3101-06AAE	3101-06AAV	10
90	80	3"	272	149	165	48.5	3101-07AAE	3101-07AAV	10
110	100	4"	327	175	170	53.5	3101-08AAE	3101-08AAV	10

OPTIONS série 3101



Autres embouts : consultez la page «fittings»
DN15 à DN50 : cadenassage de série
Other fittings: see page «fittings»
DN15 to DN50 : standard locking

ROBINET À TOURNANT SPHÉRIQUE

Ball valve

SERIE 3101



N° Fiche produit - Product sheet
TDS-BALL-3101

STANDARDS & APPROVALS



ROBINET PVC-U À TOURNANT SPHÉRIQUE 2 VOIES, DOUBLE UNION, À BRIDES

2-way PVC-U ball valve, double union, with flanges

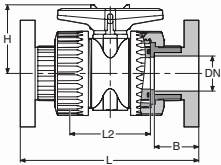

d mm	DN mm	G inch	DIMENSIONS Dimensions				RÉFÉRENCE (BRIDES DIN*) Product code (DIN flanges*)		RÉFÉRENCE (BRIDES ANSI*) Product code (ANSI flanges*)		PN bar
			L mm	L2 mm	H mm	B mm	EPDM	FPM	EPDM	FPM	
20	15	1/2"	153.5	64	47.5	45	3101-00FFE	3101-00FFV	3101-00GGE	3101-00GGV	16
25	20	3/4"	165	64	52.5	48.5	3101-01FFE	3101-01FFV	3101-01GGE	3101-01GGV	16
32	25	1"	189	69	57.5	57	3101-02FFE	3101-02FFV	3101-02GGE	3101-02GGV	16
40	32	1 1/4"	226	76.5	70	66.5	3101-03FFE	3101-03FFV	3101-03GGE	3101-03GGV	16
50	40	1 1/2"	226	93	75	66.5	3101-04FFE	3101-04FFV	3101-04GGE	3101-04GGV	16
63	50	2"	253	114	82.5	69.5	3101-05FFE	3101-05FFV	3101-05GGE	3101-05GGV	16
75	65	2 1/2"	281	116.5	92.5	82.5	3101-06FFE	3101-06FFV	3101-06GGE	3101-06GGV	10
90	80	3"	330	149	100	94	3101-07FFE	3101-07FFV	3101-07GGE	3101-07GGV	10
110	100	4"	378	175	110	101.5	3101-08FFE	3101-08FFV	3101-08GGE	3101-08GGV	10

* DIN = EN1092-1 PN10/16

ANSI = ASME B16.5 Class 150

OPTIONS série 3101



Autres embouts : consultez la page « fittings »
DN15 à DN50 : cadenassage de série
Other fittings: see page « fittings »
DN15 to DN50 : standard locking

quotes@tfpes.co.uk

ROBINETTERIE INDUSTRIELLE - Industrial valves

ROBINET À TOURNANT SPHÉRIQUE
Ball valve

SERIE 4101

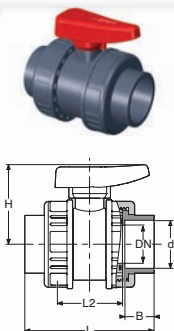
N° Fiche produit - Product sheet
TDS-BALL-4101STANDARDS &
APPROVALSROBINET PVC-U À TOURNANT SPHÉRIQUE 2 VOIES, DOUBLE UNION, EMBOUTS PVC-U FEMELLES MÉTRIQUES
2-way PVC-U ball valve, double union, PVC-U metric sockets

DIMENSIONS Dimensions							RÉFÉRENCE Product code		PN bar
d mm	DN mm	G inch	L mm	L2 mm	H mm	B mm	EPDM	FPM	
20	15	1/2"	78	46	49.5	16	4101-00BBE	4101-00BBV	16
25	20	3/4"	92	54	58	19	4101-01BBE	4101-01BBV	16
32	25	1"	105	61	68.5	22	4101-02BBE	4101-02BBV	16
40	32	1 1/4"	121	69	76	26	4101-03BBE	4101-03BBV	16
50	40	1 1/2"	141	79	91	31	4101-04BBE	4101-04BBV	16
63	50	2"	169	93	104	38	4101-05BBE	4101-05BBV	16
75	65	2 1/2"	228	140	144.5	44	4101-06BBE	4101-06BBV	16
90	80	3"	241	139	145	51	4101-07BBE	4101-07BBV	16
110	100	4"	284	162	170.5	61	4101-08BBE	4101-08BBV	16

Autres embouts : nous consulter
Other fittings: please contact us

SERIE 3001

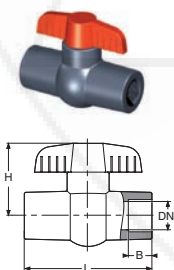
N° Fiche produit - Product sheet
TDS-BALL-3001STANDARDS &
APPROVALSROBINET PVC-U À TOURNANT SPHÉRIQUE 2 VOIES, COMPACT, SORTIES TARAUDÉES PAS DU GAZ CYLINDRIQUE
2-way compact PVC-U ball valve, BSP threaded sockets

DIMENSIONS Dimensions						RÉFÉRENCE Product code		PN bar
d mm	DN mm	G inch	L mm	H mm	B mm	EPDM		
15	10	3/8"	68.5	36	17	3000-99AAE	10	
20	15	1/2"	74.5	45	21.5	3001-00AAE	10	
25	20	3/4"	82	55	22	3001-01AAE	10	
32	25	1"	97	58	25	3001-02AAE	10	
40	32	1 1/4"	109.7	63	29	3001-03AAE	10	
50	40	1 1/2"	123	73	30	3001-04AAE	10	
63	50	2"	139.8	87	32.5	3001-05AAE	10	

ROBINET À MEMBRANE

Diaphragm valve

SERIE 2300



N° Fiche produit - Product sheet
TDS-DIAPH-2300

STANDARDS & APPROVALS



ROBINET PVC-U À MEMBRANE À BRIDES

Flanged PVC-U diaphragm valve

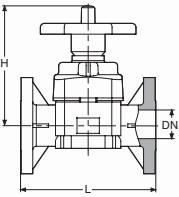

DIMENSIONS					RÉFÉRENCE (BRIDES DIN*)			RÉFÉRENCE (BRIDES ANSI*)			PN
Dimensions					Product code (DIN flanges*)			Product code (ANSI flanges*)			
d	DN	G	L	H	EPDM	FPM	PTFE	EPDM	FPM	PTFE	bar
20	15	1/2"	130	133	2300-00FFE	2300-00FFZ	2300-00FFP	2300-00GGE	2300-00GGZ	2300-00GGP	10
25	20	3/4"	150	133	2300-01FFE	2300-01FFZ	2300-01FFP	2300-01GGE	2300-01GGZ	2300-01GGP	10
32	25	1"	160	133	2300-02FFE	2300-02FFZ	2300-02FFP	2300-02GGE	2300-02GGZ	2300-02GGP	10
40	32	1"1/4	180	167	2300-03FFE	2300-03FFZ	2300-03FFP	2300-03GGE	2300-03GGZ	2300-03GGP	10
50	40	1"1/2	200	167	2300-04FFE	2300-04FFZ	2300-04FFP	2300-04GGE	2300-04GGZ	2300-04GGP	10
63	50	2"	230	205	2300-05FFE	2300-05FFZ	2300-05FFP	2300-05GGE	2300-05GGZ	2300-05GGP	10

* DIN = EN1092-1 PN10/16

ANSI = ASME B16.5 Class 150



ROBINET PVC-U À MEMBRANE, DOUBLE UNION, EMBOUTS PVC-U FEMELLES MÉTRIQUES

PVC-U diaphragm valve, double union, PVC-U metric sockets

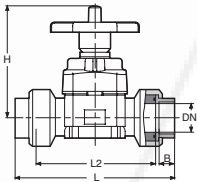

DIMENSIONS							RÉFÉRENCE			PN
Dimensions							Product code			
d	DN	G	L	L2	H	B	EPDM	FPM	PTFE	bar
20	15	1/2"	177	135	133	16,5	2300-00BBE	2300-00BBZ	2300-00BBP	10
25	20	3/4"	181	132	133	20	2300-01BBE	2300-01BBZ	2300-01BBP	10
32	25	1"	186	133	133	22,5	2300-02BBE	2300-02BBZ	2300-02BBP	10
40	32	1"1/4	228	166	167	27,5	2300-03BBE	2300-03BBZ	2300-03BBP	10
50	40	1"1/2	253	178	167	31,5	2300-04BBE	2300-04BBZ	2300-04BBP	10
63	50	2"	287	198	205	38	2300-05BBE	2300-05BBZ	2300-05BBP	10



ROBINET PVC-U À MEMBRANE, SORTIES PVC-U MÂLES

PVC-U diaphragm valve, PVC-U metric spigot outlets

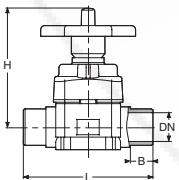

DIMENSIONS						RÉFÉRENCE			PN
Dimensions						Product code			
d	DN	G	L	H	B	EPDM	FPM	PTFE	bar
20	15	1/2"	124	133	17	2300-00ZZE	2300-00ZZZ	2300-00ZZP	10
25	20	3/4"	144	133	19.5	2300-01ZZE	2300-01ZZZ	2300-01ZZP	10
32	25	1"	154	133	23.5	2300-02ZZE	2300-02ZZZ	2300-02ZZP	10
40	32	1"1/4	174	167	27	2300-03ZZE	2300-03ZZZ	2300-03ZZP	10
50	40	1"1/2	194	167	32	2300-04ZZE	2300-04ZZZ	2300-04ZZP	10
63	50	2"	224	205	39	2300-05ZZE	2300-05ZZZ	2300-05ZZP	10

OPTIONS série 2300



- 2300 devient 2307 avec un actionneur pneumatique DE.
2300 becomes 2307 when fitted with a double acting pneumatic actuator.
- 2300 devient 2308 avec un actionneur pneumatique SE/NO.
2300 becomes 2308 when fitted with failsafe open (NO) pneumatic actuator.
- 2300 devient 2309 avec un actionneur pneumatique SE/NF.
2300 becomes 2309 when fitted with failsafe closed (NC) pneumatic actuator.

quotes@tipes.co.uk

ROBINET À MEMBRANE

Diaphragm valve

SERIE 3200



N° Fiche produit - Product sheet
TDS-DIAPH-3200



ROBINET PVC-U À MEMBRANE À BRIDES

Flanged PVC-U diaphragm valve

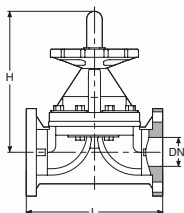

DIMENSIONS					RÉFÉRENCE (BRIDES DIN*)		RÉFÉRENCE (BRIDES ANSI*)			
Dimensions					Product code (DIN flanges*)		Product code (ANSI flanges*)		PN	PN
d	DN	G	L	H	EPDM	PTFE	EPDM	PTFE	bar	bar
mm	mm	inch	mm	mm					EPDM	PTFE
75	65	2"1/2	290	276	3200-06FFE	3200-06FFP	3200-06GGE	3200-06GGP	10	5
90	80	3"	310	293	3200-07FFE	3200-07FFP	3200-07GGE	3200-07GGP	10	5
110	100	4"	350	370	3200-08FFE	3200-08FFP	3200-08GGE	3200-08GGP	10	5
125	125	5"	400	412	3200-09FFE	3200-09FFP	3200-09GGE	3200-09GGP	5	4
160	150	6"	480	471	3200-10FFE	3200-10FFP	3200-10FFE	3200-10FFP	5	4
225	200	8"	600	625	3200-11FFE	3200-11FFP	3200-11GGE	3200-11GGP	3	2
280	250	10"	680	750	3200-12FFE	3200-12FFP	3200-12GGE	3200-12GGP	3	2

* DIN = EN1092-1 PN10

ANSI = ASME B16.5 Class 150

OPTIONS série 3200



ROBINET À PAPILLON

Butterfly valve

SERIE 3600



N° Fiche produit - Product sheet
TDS-BUTT-3600

STANDARDS & APPROVALS



ROBINET À PAPILLON, CORPS PVC-U, PAPILLON PVC-U, MONTAGE WAFER ENTRE BRIDES, COMMANDE PAR POIGNÉE
Butterfly valve, PVC-U body, PVC-U butterfly, wafer type, with lever handle

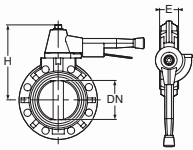

DIMENSIONS Dimensions					RÉFÉRENCE (BRIDES DIN*) Product code (DIN flanges*)		RÉFÉRENCE (BRIDES ANSI*) Product code (ANSI flanges*)		PN bar
d mm	DN mm	G inch	H mm	E mm	EPDM	FPM	EPDM	FPM	
63	50	2"	168	43	3600-05WWE	3600-05WWV	3600A05WWE	3600A05WWV	10
75	65	2 1/2"	178	45	3600-06WWE	3600-06WWV	3600A06WWE	3600A06WWV	10
90	80	3"	183	45	3600-07WWE	3600-07WWV (1)	3600A07WWE	3600A07WWV (1)	10
110	100	4"	196	55	3600-08WWE	3600-08WWV (1)	3600A08WWE	3600A08WWV (1)	10
140	125	5"	256	65	3600-09WWE	3600-09WWV	3600A09WWE	3600A09WWV	10
160	150	6"	276	70	3600-10WWE	3600-10WWV (1)	3600-10WWE	3600-10WWV (1)	10
225	200	8"	297	87	3600L11WWE	3600L11WWV	3600AL11WWE	3600AL11WWV	10

* DIN = EN1092-1 PN10/16 ANSI = ASME B16.5 Class 150
(1) possibilité de manchette FPM haute performance (FPM grade F).
(1) possibility of gasket in high performance FPM (F grade).



N° Fiche produit - Product sheet
TDS-BUTT-3600A

STANDARDS & APPROVALS



ROBINET À PAPILLON, CORPS PVC-U, PAPILLON PVC-U, MONTAGE WAFER ENTRE BRIDES, COMMANDE PAR RÉDUCTEUR MANUEL
Butterfly valve, PVC-U body, PVC-U butterfly, wafer type, with handwheel and reduction gearbox

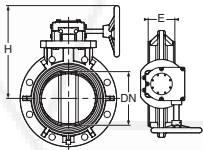

DIMENSIONS Dimensions					RÉFÉRENCE (BRIDES DIN*) Product code (DIN flanges*)		RÉFÉRENCE (BRIDES ANSI*) Product code (ANSI flanges*)		PN bar
d mm	DN mm	G inch	H mm	E mm	EPDM	FPM	EPDM	FPM	
225	200	8"	322	87	3600-11WWE	3600-11WWV	3600A11WWE	3600A11WWV	10
280	250	10"	322	106	3600-12WWE	3600-12WWV	3600A12WWE	3600A12WWV	10
315	300	12"	463.5	128	3600-13WWE	3600-13WWV	3600A13WWE	3600A13WWV	7
355	350	14"	481.5	128	3600-14WWE	3600-14WWV	3600A14WWE	3600A14WWV	7
400	400	16"	606	169	3600-15WWE	3600-15WWV	3600A15WWE	3600A15WWV	6
450	450	18"	608	181	3600-16WWE	3600-16WWV	3600A16WWE	3600A16WWV	5
500	500	20"	648	191	3600-17WWE	3600-17WWV	3600A17WWE	3600A17WWV	3.5
630	600	24"	635	209	3600-18WWE	3600-18WWV	3600A18WWE	3600A18WWV	3.5

* DIN = EN1092-1 PN10 ANSI = ASME B16.5 Class 150

OPTIONS série 3600

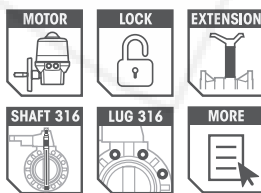

Pour commander un robinet papillon prêt pour motorisation, rajouter la référence ACTUREADY après celle du robinet. Par exemple 3600-05WWE + ACTUREADY
- pour les DN50 à 200 : la poignée crantée est enlevée, la face est dressée et percée
- pour les DN250 et supérieurs : le réducteur est enlevé
Les kits de motorisation pour robinets papillons se trouvent en page 170 du catalogue.

To order a butterfly valve ready for actuation, please add the code ACTUREADY after the code of the valve. For example 3600-05WWE + ACTUREADY
- for DN50 to 200 : the handled is removed, the face is machined and drilled
- for DN250 and higher : the gearbox is removed
The actuation kits for butterfly valves can be found on page 170 of the catalog.

CLAPET

Check valve

SERIE 4094



N° Fiche produit - Product sheet
TDS-CHECK-4094

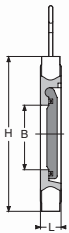

CLAPET PVC-U À BATTANT, MONTAGE WAFER ENTRE BRIDES

Wafer PVC-U swing check valve

DIMENSIONS						RÉFÉRENCE (BRIDES DIN*)		RÉFÉRENCE (BRIDES ANSI*)		PN
Dimensions						Product code (DIN flanges*)		Product code (ANSI flanges*)		
d	DN	G	L	H	B	EPDM	FPM	EPDM	FPM	bar
mm	mm	inch	mm	mm	mm					
40	32	1"1/4	15	85	18	4094D03EP	4094D03VT	4094A03EP	4094A03VT	10
50	40	1"1/2	16	95	22	4094D04EP	4094D04VT	4094A04EP	4094A04VT	10
63	50	2"	18	109	32	4094D05EP	4094D05VT	4094A05EP	4094A05VT	10
75	65	2"1/2	20	129	40	4094D06EP	4094D06VT	4094A06EP	4094A06VT	10
90	80	3"	20	144	54	4094D07EP	4094D07VT	4094A07EP	4094A07VT	10
110	100	4"	23	164	70	4094D08EP	4094D08VT	4094A08EP	4094A08VT	10
140	125	5"	23	195	92	4094D09EP	4094D09VT	4094A09EP	4094A09VT	10
160	150	6"	26	220	105	4094D10EP	4094D10VT	4094A10EP	4094A10VT	6
225	200	8"	34	275	154	4094D11EP	4094D11VT	4094A11EP	4094A11VT	6
280	250	10"	40	330	192	4094D12EP	4094D12VT	4094A12EP	4094A12VT	5
315	300	12"	45	380	227	4094D13EP	4094D13VT	4094A13EP	4094A13VT	5
355	350	14"	49	440	266	4094D14EP	4094D14VT	4094A14EP	4094A14VT	3
400	400	16"	65	491	310	4094D15EP	4094D15VT	4094A15EP	4094A15VT	3
450	450	18"	78	541	350	4094D16EP	4094D16VT	4094A16EP	4094A16VT	3
500	500	20"	78	596	400	4094D17EP	4094D17VT	4094A17EP	4094A17VT	3

* DIN = EN1092-1 PN10

ANSI = ASME B16.5 Class 150

CLAPET PVC-U À BATTANT, MONTAGE WAFER ENTRE BRIDES, AVEC RESSORT EN INOX 316

Wafer PVC-U swing check valve with SS316 spring

DIMENSIONS						RÉFÉRENCE (BRIDES DIN*)		RÉFÉRENCE (BRIDES ANSI*)		PN
Dimensions						Product code (DIN flanges*)		Product code (ANSI flanges*)		
d	DN	G	L	H	B	EPDM	FPM	EPDM	FPM	bar
mm	mm	inch	mm	mm	mm					
40	32	1"1/4	15	85	18	4094DR03EP	4094DR03VT	4094AR03EP	4094AR03VT	10
50	40	1"1/2	16	95	22	4094DR04EP	4094DR04VT	4094AR04EP	4094AR04VT	10
63	50	2"	18	109	32	4094DR05EP	4094DR05VT	4094AR05EP	4094AR05VT	10
75	65	2"1/2	20	129	40	4094DR06EP	4094DR06VT	4094AR06EP	4094AR06VT	10
90	80	3"	20	144	54	4094DR07EP	4094DR07VT	4094AR07EP	4094AR07VT	10
110	100	4"	23	164	70	4094DR08EP	4094DR08VT	4094AR08EP	4094AR08VT	10
140	125	5"	23	195	92	4094DR09EP	4094DR09VT	4094AR09EP	4094AR09VT	10
160	150	6"	26	220	105	4094DR10EP	4094DR10VT	4094AR10EP	4094AR10VT	6
225	200	8"	34	275	154	4094DR11EP	4094DR11VT	4094AR11EP	4094AR11VT	6
280	250	10"	40	330	192	4094DR12EP	4094DR12VT	4094AR12EP	4094AR12VT	5
315	300	12"	45	380	227	4094DR13EP	4094DR13VT	4094AR13EP	4094AR13VT	5
355	350	14"	49	440	266	4094DR14EP	4094DR14VT	4094AR14EP	4094AR14VT	3
400	400	16"	65	491	310	4094DR15EP	4094DR15VT	4094AR15EP	4094AR15VT	3
450	450	18"	78	541	350	4094DR16EP	4094DR16VT	4094AR16EP	4094AR16VT	3
500	500	20"	78	596	400	4094DR17EP	4094DR17VT	4094AR17EP	4094AR17VT	3

* DIN = EN1092-1 PN10

ANSI = ASME B16.5 Class 150

Les cotes H sont données pour un clapet DIN.
Pour un clapet ANSI, consulter la fiche produit.
The dimension H is for a DIN valve.
For an ANSI valve, check the product sheet.

CLAPET
Check valve

SERIE 3300



N° Fiche produit - Product sheet
TDS-CHECK-3300

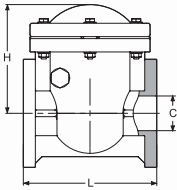

CLAPET PVC-U À BATTANT À BRIDES
Flanged PVC-U swing check valve

d mm	DN mm	G inch	DIMENSIONS Dimensions			RÉFÉRENCE (BRIDES DIN*) Product code (DIN flanges*)		RÉFÉRENCE (BRIDES ANSI*) Product code (ANSI flanges*)		PN** bar
			L mm	H mm	C mm	EPDM	FPM	EPDM	FPM	
20	15	1/2"	160	129	25	3300-00FFE	3300-00FFV	3300-00GGE	3300-00GGV	6
25	20	3/4"	160	129	25	3300-01FFE	3300-01FFV	3300-01GGE	3300-01GGV	6
32	25	1"	160	129	25	3300-02FFE	3300-02FFV	3300-02GGE	3300-02GGV	6
40	32	1"1/4	180	141	41	3300-03FFE	3300-03FFV	3300-03GGE	3300-03GGV	6
50	40	1"1/2	180	141	41	3300-04FFE	3300-04FFV	3300-04GGE	3300-04GGV	6
63	50	2"	200	165	52	3300-05FFE	3300-05FFV	3300-05GGE	3300-05GGV	6
75	65	2"1/2	260	180	80	3300-06FFE	3300-06FFV	3300-06GGE	3300-06GGV	6
90	80	3"	260	180	80	3300-07FFE	3300-07FFV	3300-07GGE	3300-07GGV	6
110	100	4"	300	216	100	3300-08FFE	3300-08FFV	3300-08GGE	3300-08GGV	5
140	125	5"	350	240	125	3300-09FFE	3300-09FFV	3300-09GGE	3300-09GGV	5
160	150	6"	400	273	150	3300-10FFE	3300-10FFV	3300-10FFE	3300-10FFV	4
225	200	8"	500	310	200	3300-11FFE	3300-11FFV	3300-11GGE	3300-11GGV	3

* DIN = EN1092-1 PN10
** PN 10 : nous consulter
** PN 10: consult us

ANSI = ASME B16.5 Class 150

quotes@tipes.co.uk

CLAPET

Check valve

SERIE 3307



N° Fiche produit - Product sheet
TDS-CHECK-3307

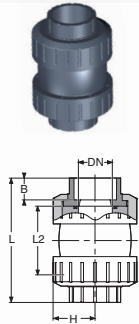

CLAPET ANTI-RETOUR PVC-U À BILLE, DOUBLE UNION, EMBOUTS PVC-U FEMELLES MÉTRIQUES

PVC-U Ball check valve, double union, PVC-U metric sockets

DIMENSIONS Dimensions							RÉFÉRENCE Product code		
d	DN	G	L	L2	H	B	EPDM	FPM	PN
mm	mm	inch	mm	mm	mm	mm			bar
20	15	1/2"	105	53	27	17	3307-00BBE	3307-00BBV	10
25	20	3/4"	119	60.5	32	18.5	3307-01BBE	3307-01BBV	10
32	25	1"	136	68	36.5	21	3307-02BBE	3307-02BBV	10
40	32	1"1/4	176	85	49	26	3307-03BBE	3307-03BBV	10
50	40	1"1/2	176	85	49	34	3307-04BBE	3307-04BBV	10
63	50	2"	196	106	60.5	38	3307-05BBE	3307-05BBV	10
75	65	2"1/2	222	108	75	45	3307-06BBE	3307-06BBV	7
90	80	3"	274	147	92	51	3307-07BBE	3307-07BBV	7
110	100	4"	361	211	99.5	61	3307-08BBE	3307-08BBV	7

Montage vertical uniquement
Vertical fitting only

CLAPET ANTI-RETOUR PVC-U À BILLE, DOUBLE UNION, EMBOUTS PVC-U TARAUDÉS PAS DU GAZ CYLINDRIQUE

PVC-U Ball check valve, double union, PVC-U BSP threaded sockets

DIMENSIONS Dimensions							RÉFÉRENCE Product code		
d	DN	G	L	L2	H	B	EPDM	FPM	PN
mm	mm	inch	mm	mm	mm	mm			bar
20	15	1/2"	105	53	27	22.5	3307-00AAE	3307-00AAV	10
25	20	3/4"	119	60.5	32	25.5	3307-01AAE	3307-01AAV	10
32	25	1"	136	68	36.5	29	3307-02AAE	3307-02AAV	10
40	32	1"1/4	176	85	49	35	3307-03AAE	3307-03AAV	10
50	40	1"1/2	176	85	49	36	3307-04AAE	3307-04AAV	10
63	50	2"	196	106	60.5	38	3307-05AAE	3307-05AAV	10
75	65	2"1/2	222	108	75	45	3307-06AAE	3307-06AAV	7
90	80	3"	274	147	92	48.5	3307-07AAE	3307-07AAV	7
110	100	4"	362	211	99.5	53.5	3307-08AAE	3307-08AAV	7

Montage vertical uniquement
Vertical fitting only

CLAPET ANTI-RETOUR PVC-U À BILLE, DOUBLE UNION, À BRIDES

PVC-U Ball check valve, double union, with flanges

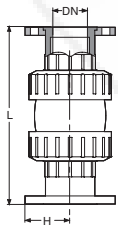

DIMENSIONS Dimensions					RÉFÉRENCE (BRIDES DIN*) Product code (DIN flanges*)		RÉFÉRENCE (BRIDES ANSI*) Product code (ANSI flanges*)		PN bar
d	DN	G	L	H	EPDM	FPM	EPDM	FPM	
mm	mm	inch	mm	mm					
20	15	1/2"	145	47.5	3307-00FFE	3307-00FFV	3307-00GGE	3307-00GGV	10
25	20	3/4"	159	52.5	3307-01FFE	3307-01FFV	3307-01GGE	3307-01GGV	10
32	25	1"	184	57.5	3307-02FFE	3307-02FFV	3307-02GGE	3307-02GGV	10
40	32	1"1/4	220	70	3307-03FFE	3307-03FFV	3307-03GGE	3307-03GGV	10
50	40	1"1/2	220	75	3307-04FFE	3307-04FFV	3307-04GGE	3307-04GGV	10
63	50	2"	248	82.5	3307-05FFE	3307-05FFV	3307-05GGE	3307-05GGV	10
75	65	2"1/2	276	92.5	3307-06FFE	3307-06FFV	3307-06GGE	3307-06GGV	7
90	80	3"	340	100	3307-07FFE	3307-07FFV	3307-07GGE	3307-07GGV	7
110	100	4"	422	110	3307-08FFE	3307-08FFV	3307-08GGE	3307-08GGV	7

* DIN = EN1092-1 PN10

ANSI = ASME B16.5 Class 150

Montage vertical uniquement
Vertical fitting only

FILTRE
Strainer

SERIE 4640



N° Fiche produit - Product sheet
TDS-INCL-4640

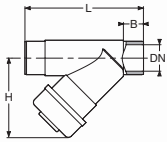

FILTRE EN Y EN PVC-U TRANSPARENT, MAILLE DE 0.5 MM, SORTIES PVC-U MÂLES
Y strainer in transparent PVC-U, mesh size 0.5 mm, PVC-U spigot outlets

DIMENSIONS Dimensions						RÉFÉRENCE Product code		
d	DN	G	L	H	B	EPDM	FPM	PN
mm	mm	inch	mm	mm	mm			bar
20	15	1/2"	124	75	16	4640-00ZZE05T	4640-00ZZV05T	10
25	20	3/4"	144	80	19	4640-01ZZE05T	4640-01ZZV05T	10
32	25	1"	154	90	22	4640-02ZZE05T	4640-02ZZV05T	10
40	32	1"1/4	171	110	26	4640-03ZZE05T	4640-03ZZV05T	10
50	40	1"1/2	195	128	31	4640-04ZZE05T	4640-04ZZV05T	10
63	50	2"	226	150	38	4640-05ZZE05T	4640-05ZZV05T	10

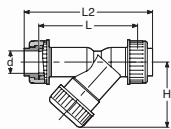

FILTRE EN Y EN PVC-U TRANSPARENT, MAILLE DE 0.5 MM, DOUBLE UNION, EMBOUTS PVC-U FEMELLES MÉTRIQUES
Y strainer in transparent PVC-U, mesh size 0.5 mm, double union, PVC-U metric sockets

DIMENSIONS Dimensions						RÉFÉRENCE Product code		
d	DN	G	L	L2	H	EPDM	FPM	PN
mm	mm	inch	mm	mm	mm			bar
20	15	1/2"	150	182	75	4640-00BBE05T	4640-00BBV05T	10
25	20	3/4"	170	208	80	4640-01BBE05T	4640-01BBV05T	10
32	25	1"	183	224	90	4640-02BBE05T	4640-02BBV05T	10
40	32	1"1/4	209	256	110	4640-03BBE05T	4640-03BBV05T	10
50	40	1"1/2	235	290	128	4640-04BBE05T	4640-04BBV05T	10
63	50	2"	270	342	150	4640-05BBE05T	4640-05BBV05T	10

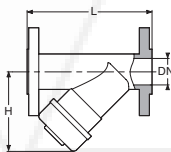

FILTRE EN Y EN PVC-U TRANSPARENT, MAILLE DE 0.5 MM, À BRIDES DIN*
Y strainer in transparent PVC-U, mesh size 0.5 mm, with DIN* flanges

DIMENSIONS Dimensions					RÉFÉRENCE Product code		
d	DN	G	L	H	EPDM	FPM	PN
mm	mm	inch	mm	mm			bar
20	15	1/2"	130	75	4640-00FFE05T	4640-00FFV05T	10
25	20	3/4"	150	80	4640-01FFE05T	4640-01FFV05T	10
32	25	1"	160	90	4640-02FFE05T	4640-02FFV05T	10
40	32	1"1/4	180	110	4640-03FFE05T	4640-03FFV05T	10
50	40	1"1/2	200	128	4640-04FFE05T	4640-04FFV05T	10
63	50	2"	230	150	4640-05FFE05T	4640-05FFV05T	10

* DIN = EN1092-1 PN10/16

Autre taille de maille, nous consulter
Please contact us for other mesh size

FILTRE Strainer

SERIE 4650



N° Fiche produit - Product sheet
TDS-INCL-4640

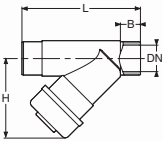

FILTRE EN Y EN PVC-U, MAILLE DE 0.5 MM, SORTIES PVC-U MÂLES

Y strainer in PVC-U, mesh size 0.5 mm, PVC-U spigot outlets

DIMENSIONS Dimensions						RÉFÉRENCE Product code		
d	DN	G	L	H	B	EPDM	FPM	PN
mm	mm	inch	mm	mm	mm			bar
20	15	1/2"	124	75	16	4650-00ZZE05T	4650-00ZZV05T	10
25	20	3/4"	144	80	19	4650-01ZZE05T	4650-01ZZV05T	10
32	25	1"	154	90	22	4650-02ZZE05T	4650-02ZZV05T	10
40	32	1"1/4"	171	110	26	4650-03ZZE05T	4650-03ZZV05T	10
50	40	1"1/2"	195	128	31	4650-04ZZE05T	4650-04ZZV05T	10
63	50	2"	226	150	38	4650-05ZZE05T	4650-05ZZV05T	10

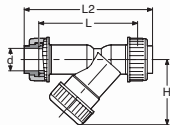

FILTRE EN Y EN PVC-U, MAILLE DE 0.5 MM, DOUBLE UNION, EMBOUTS PVC-U FEMELLES MÉTRIQUES

Y strainer in PVC-U, mesh size 0.5 mm, double union, PVC-U metric sockets

DIMENSIONS Dimensions						RÉFÉRENCE Product code		
d	DN	G	L	L2	H	EPDM	FPM	PN
mm	mm	inch	mm	mm	mm			bar
20	15	1/2"	150	182	75	4650-00BBE05T	4650-00BBV05T	10
25	20	3/4"	170	208	80	4650-01BBE05T	4650-01BBV05T	10
32	25	1"	183	224	90	4650-02BBE05T	4650-02BBV05T	10
40	32	1"1/4"	209	256	110	4650-03BBE05T	4650-03BBV05T	10
50	40	1"1/2"	235	290	128	4650-04BBE05T	4650-04BBV05T	10
63	50	2"	270	342	150	4650-05BBE05T	4650-05BBV05T	10

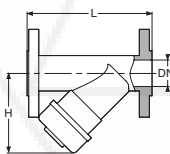

FILTRE EN Y EN PVC-U, MAILLE DE 0.5 MM, À BRIDES DIN*

Y strainer in PVC-U, mesh size 0.5 mm, with DIN* flanges

DIMENSIONS Dimensions					RÉFÉRENCE Product code		
d	DN	G	L	H	EPDM	FPM	PN
mm	mm	inch	mm	mm			bar
20	15	1/2"	130	75	4650-00FFE05T	4650-00FFV05T	10
25	20	3/4"	150	80	4650-01FFE05T	4650-01FFV05T	10
32	25	1"	160	90	4650-02FFE05T	4650-02FFV05T	10
40	32	1"1/4"	180	110	4650-03FFE05T	4650-03FFV05T	10
50	40	1"1/2"	200	128	4650-04FFE05T	4650-04FFV05T	10
63	50	2"	230	150	4650-05FFE05T	4650-05FFV05T	10

* DIN = EN1092-1 PN10/16

Autre taille de maille, nous consulter
Please contact us for other mesh size

FILTRE
Strainer

SERIE 4650



N° Fiche produit - Product sheet
TDS-INCL-4640 A

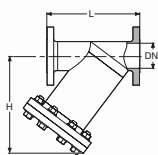

FILTRE EN Y EN PVC-U, MAILLE DE 2.0 MM, À BRIDES DIN*
Y strainer in PVC-U, mesh size 2.0 mm, with DIN* flanges

DIMENSIONS Dimensions					RÉFÉRENCE Product code			
d	DN	G	L	H	EPDM	FPM	PN	
mm	mm	inch	mm	mm			bar	
75	65	2"1/2	370	260	4650-06FFE20T	4650-06FFV20T	2	
90	80	3"	410	275	4650-07FFE20T	4650-07FFV20T	2	
110	100	4"	490	325	4650-08FFE20T	4650-08FFV20T	2	
140	125	5"	550	380	4650-09FFE20T	4650-09FFV20T	2	
160	150	6"	600	430	4650-10FFE20T	4650-10FFV20T	2	

* DIN = EN1092-1 PN10/16

Autre taille de maille, nous consulter
Please contact us for other mesh size

quotes@tfpes.co.uk

PVC-C

Tel: 01626 201092



ROBINETTERIE INDUSTRIELLE - Industrial valves

PVC-C

Le PVC surchloré (PVC-C), outre sa densité supérieure au PVC-U, présente une plus grande plage de tenue thermique (jusqu'à 90 °C environ). La présence de chlore dans le PVC-C rend néanmoins son utilisation contestée. Il est dans ce cas souvent remplacé par l'ABS ou le PP-H.

Chlorinated polyvinyl chloride (PVC-C) with its superior density presents a greater range of thermal behaviour (up to approximately 90°C) than PVC-U. Because of the presence of chlorine in the PVC-C, its use is contested. In this case, it is often replaced by ABS or PP-H.

0°C → +90°C

TEMPÉRATURE DE SERVICE
Operating temperature

ROBINET À TOURNANT SPHÉRIQUE

Ball valve

SERIE 3111



N° Fiche produit - Product sheet
TDS-BALL-3101

STANDARDS & APPROVALS

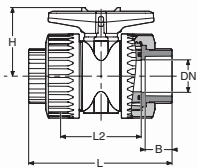

ROBINET PVC-C À TOURNANT SPHÉRIQUE 2 VOIES, DOUBLE UNION, EMBOUTS PVC-C FEMELLES MÉTRIQUES

2-way PVC-C ball valve, double union, PVC-C metric sockets

DIMENSIONS							RÉFÉRENCE		
Dimensions							Product code		
d	DN	G	L	L2	H	B	EPDM	FPM	PN
mm	mm	inch	mm	mm	mm	mm			bar
15	10	3/8"	115	64	48	15	3111-99BBE	3111-99BBV	16
20	15	1/2"	115	64	51	17	3111-00BBE	3111-00BBV	16
25	20	3/4"	126	64	62	18.5	3111-01BBE	3111-01BBV	16
32	25	1"	144	69	69	21	3111-02BBE	3111-02BBV	16
40	32	1"1/4	183	76.5	85	26	3111-03BBE	3111-03BBV	16
50	40	1"1/2	183	93	85	35	3111-04BBE	3111-04BBV	16
63	50	2"	202	114	98	38	3111-05BBE	3111-05BBV	16
75	65	2"1/2	233	116.5	142	45	3111-06BBE	3111-06BBV	10
90	80	3"	274	149	165	51	3111-07BBE	3111-07BBV	10
110	100	4"	325	175	170	61	3111-08BBE	3111-08BBV	10

ROBINET PVC-C À TOURNANT SPHÉRIQUE 2 VOIES, DOUBLE UNION, EMBOUTS PVC-C TARAUDÉS PAS DU GAZ CYLINDRIQUE

2-way PVC-C ball valve, double union, PVC-C BSP threaded sockets

DIMENSIONS							RÉFÉRENCE		
Dimensions							Product code		
d	DN	G	L	L2	H	B	EPDM	FPM	PN
mm	mm	inch	mm	mm	mm	mm			bar
15	10	3/8"	115	64	48	22.5	3111-99AAE	3111-99AAV	10
20	15	1/2"	115	64	51	22.5	3111-00AAE	3111-00AAV	10
25	20	3/4"	127	64	62	25.5	3111-01AAE	3111-01AAV	10
32	25	1"	145	69	69	29	3111-02AAE	3111-02AAV	10
40	32	1"1/4	183	76.5	85	35	3111-03AAE	3111-03AAV	10
50	40	1"1/2	183	93	85	36	3111-04AAE	3111-04AAV	10
63	50	2"	203	114	98	38	3111-05AAE	3111-05AAV	10
75	65	2"1/2	230	116.5	142	45	3111-06AAE	3111-06AAV	10
90	80	3"	272	149	165	48.5	3111-07AAE	3111-07AAV	10
110	100	4"	327	175	170	53.5	3111-08AAE	3111-08AAV	10

OPTIONS série 3111



Autres embouts : consultez la page «fittings»
DN15 à DN50 : cadenasage de série
Other fittings: see page «fittings»
DN15 to DN50 : standard locking

ROBINET À TOURNANT SPHÉRIQUE

Ball valve

SERIE 3111



N° Fiche produit - Product sheet
TDS-BALL-3101

STANDARDS & APPROVALS



ROBINET PVC-C À TOURNANT SPHÉRIQUE 2 VOIES, DOUBLE UNION, À BRIDES

2-way PVC-C ball valve, double union, with flanges

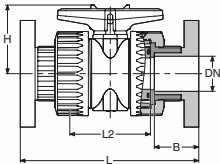

DIMENSIONS Dimensions							RÉFÉRENCE (BRIDES DIN*) Product code (DIN flanges*)		RÉFÉRENCE (BRIDES ANSI*) Product code (ANSI flanges*)		PN bar
d mm	DN mm	G inch	L mm	L2 mm	H mm	B mm	EPDM	FPM	EPDM	FPM	
20	15	1/2"	153.5	64	47.5	45	3111-00FFE	3111-00FFV	3111-00GGE	3111-00GGV	16
25	20	3/4"	165	64	52.5	48.5	3111-01FFE	3111-01FFV	3111-01GGE	3111-01GGV	16
32	25	1"	189	69	57.5	57	3111-02FFE	3111-02FFV	3111-02GGE	3111-02GGV	16
40	32	1"1/4	226	76.5	70	66.5	3111-03FFE	3111-03FFV	3111-03GGE	3111-03GGV	16
50	40	1"1/2	226	93	75	66.5	3111-04FFE	3111-04FFV	3111-04GGE	3111-04GGV	16
63	50	2"	253	114	82.5	70	3111-05FFE	3111-05FFV	3111-05GGE	3111-05GGV	16
75	65	2"1/2	281	116.5	92.5	82.5	3111-06FFE	3111-06FFV	3111-06GGE	3111-06GGV	10
90	80	3"	330	149	100	94	3111-07FFE	3111-07FFV	3111-07GGE	3111-07GGV	10
110	100	4"	378	175	110	101.5	3111-08FFE	3111-08FFV	3111-08GGE	3111-08GGV	10

* DIN = EN1092-1 PN10

ANSI = ASME B16.5 Class 150

OPTIONS série 3111



Autres embouts : consultez la page « fittings »
DN15 à DN50 : cadenassage de série
Other fittings: see page « fittings »
DN15 to DN50 : standard locking

quotes@tfpes.co.uk

PVC-C

ROBINET À MEMBRANE

Diaphragm valve

SERIE 3211



N° Fiche produit - Product sheet
TDS-DIAPH-3200



ROBINET PVC-C À MEMBRANE À BRIDES
Flanged PVC-C diaphragm valve

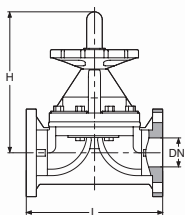

DIMENSIONS Dimensions					RÉFÉRENCE (BRIDES DIN*) Product code (DIN flanges*)		RÉFÉRENCE (BRIDES ANSI*) Product code (ANSI flanges*)		PN bar EPDM	PN bar PTFE
d mm	DN mm	G inch	L mm	H mm	EPDM	PTFE	EPDM	PTFE		
75	65	2"1/2	290	276	3211-06FFE	3211-06FFP	3211-06GGE	3211-06GGP	10	5
90	80	3"	310	293	3211-07FFE	3211-07FFP	3211-07GGE	3211-07GGP	10	5
110	100	4"	350	370	3211-08FFE	3211-08FFP	3211-08GGE	3211-08GGP	10	5
125	125	5"	400	412	3211-09FFE	3211-09FFP	3211-09GGE	3211-09GGP	5	4
160	150	6"	480	471	3211-10FFE	3211-10FFP	3211-10FFE	3211-10FFP	5	4
225	200	8"	600	625	3211-11FFE	3211-11FFP	3211-11GGE	3211-11GGP	3	2
280	250	10"	680	750	3211-12FFE	3211-12FFP	3211-12GGE	3211-12GGP	3	2

* DIN = EN1092-1 PN10

ANSI = ASME B1.6.5 Class 150

OPTIONS série 3211



quotes@tipes.co.uk

ROBINET À PAPILLON

Butterfly valve

SERIE 3610



N° Fiche produit - Product sheet
TDS-BUTT-3600

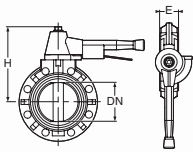

ROBINET À PAPILLON, CORPS PVC-C PAPILLON PVC-C, MONTAGE WAFER ENTRE BRIDES, COMMANDE PAR POIGNÉE

Butterfly valve, PVC-C body, PVC-C butterfly, wafer type, with lever handle

DIMENSIONS					RÉFÉRENCE (BRIDES DIN*)		RÉFÉRENCE (BRIDES ANSI*)		PN
Dimensions					Product code (DIN flanges*)		Product code (ANSI flanges*)		
d	DN	G	H	E	EPDM	FPM	EPDM	FPM	bar
mm	mm	inch	mm	mm					
63	50	2"	168	43	3610-05WWE	3610-05WWV	3610A05WWE	3610A05WWV	10
75	65	2"1/2	178	45	3610-06WWE	3610-06WWV	3610A06WWE	3610A06WWV	10
90	80	3"	183	45	3610-07WWE	3610-07WWV (1)	3610A07WWE	3610A07WWV (1)	10
110	100	4"	196	55	3610-08WWE	3610-08WWV (1)	3610A08WWE	3610A08WWV (1)	10
140	125	5"	256	65	3610-09WWE	3610-09WWV	3610A09WWE	3610A09WWV	10
160	150	6"	276	70	3610-10WWE	3610-10WWV (1)	3610-10WWE	3610-10WWV (1)	10
225	200	8"	297	87	3610L11WWE	3610L11WWV	3610AL11WWE	3610AL11WWV	10

* DIN = EN1092-1 PN10/16 ANSI = ASME B16.5 Class 150
(1) possibilité de manchette FPM haute performance (FPM grade F).
(1) possibility of gasket in high performance FPM (F grade).



N° Fiche produit - Product sheet
TDS-BUTT-3600A

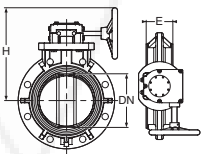

ROBINET À PAPILLON, CORPS PVC-C, PAPILLON PVC-C, MONTAGE WAFER ENTRE BRIDES, COMMANDE PAR RÉDUCTEUR MANUEL

Butterfly valve, PVC-C body, PVC-C butterfly, wafer type, with handwheel and reduction gearbox

DIMENSIONS					RÉFÉRENCE (BRIDES DIN*)		RÉFÉRENCE (BRIDES ANSI*)		PN
Dimensions					Product code (DIN flanges*)		Product code (ANSI flanges*)		
d	DN	G	H	E	EPDM	FPM	EPDM	FPM	bar
mm	mm	inch	mm	mm					
225	200	8"	322	87	3610-11WWE	3610-11WWV	3610A11WWE	3610A11WWV	10
280	250	10"	322	106	3610-12WWE	3610-12WWV	3610A12WWE	3610A12WWV	10
315	300	12"	463.5	128	3610-13WWE	3610-13WWV	3610A13WWE	3610A13WWV	7
355	350	14"	481.5	128	3610-14WWE	3610-14WWV	3610A14WWE	3610A14WWV	7
400	400	16"	606	169	3610-15WWE	3610-15WWV	3610A15WWE	3610A15WWV	6
450	450	18"	608	181	3610-16WWE	3610-16WWV	3610A16WWE	3610A16WWV	5
500	500	20"	648	191	3610-17WWE	3610-17WWV	3610A17WWE	3610A17WWV	3.5

* DIN = EN1092-1 PN10 ANSI = ASME B16.5 Class 150

OPTIONS série 3610

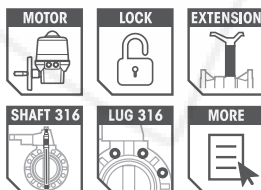

Pour commander un robinet papillon prêt pour motorisation, rajouter la référence ACTUREADY après celle du robinet. Par exemple 3610-05WWE + ACTUREADY
- pour les DN50 à 200 : la poignée crantée est enlevée, la face est dressée et percée
- pour les DN250 et supérieurs : le réducteur est enlevé
Les kits de motorisation pour robinets papillons se trouvent en page 170 du catalogue.

To order a butterfly valve ready for actuation, please add the code ACTUREADY after the code of the valve. For example 3610-05WWE + ACTUREADY
- for DN50 to 200 : the handled is removed, the face is machined and drilled
- for DN250 and higher : the gearbox is removed
The actuation kits for butterfly valves can be found on page 170 of the catalog.

CLAPET
Check valve

SERIE 3319



N° Fiche produit - Product sheet
TDS-CHECK-3300

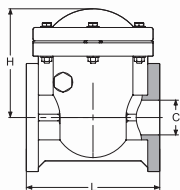

CLAPET PVC-C À BATTANT À BRIDES
Flanged PVC-C swing check valve

d	DN	DIMENSIONS				RÉFÉRENCE (BRIDES DIN*)		RÉFÉRENCE (BRIDES ANSI*)		PN**
		Dimensions				Product code (DIN flanges*)		Product code (ANSI flanges*)		
mm	mm	G inch	L mm	H mm	C mm	EPDM	FPM	EPDM	FPM	bar
20	15	1/2"	160	129	25	3319-00FFE	3319-00FFV	3319-00GGE	3319-00GGV	6
25	20	3/4"	160	129	25	3319-01FFE	3319-01FFV	3319-01GGE	3319-01GGV	6
32	25	1"	160	129	25	3319-02FFE	3319-02FFV	3319-02GGE	3319-02GGV	6
40	32	1 1/4"	180	141	41	3319-03FFE	3319-03FFV	3319-03GGE	3319-03GGV	6
50	40	1 1/2"	180	141	41	3319-04FFE	3319-04FFV	3319-04GGE	3319-04GGV	6
63	50	2"	200	165	52	3319-05FFE	3319-05FFV	3319-05GGE	3319-05GGV	6
75	65	2 1/2"	260	180	80	3319-06FFE	3319-06FFV	3319-06GGE	3319-06GGV	6
90	80	3"	260	180	80	3319-07FFE	3319-07FFV	3319-07GGE	3319-07GGV	6
110	100	4"	300	216	100	3319-08FFE	3319-08FFV	3319-08GGE	3319-08GGV	5
140	125	5"	350	239.5	125	3319-09FFE	3319-09FFV	3319-09GGE	3319-09GGV	5
160	150	6"	400	273	150	3319-10FFE	3319-10FFV	3319-10FFE	3319-10FFV	4
225	200	8"	500	310	200	3319-11FFE	3319-11FFV	3319-11GGE	3319-11GGV	3

* DIN = EN1092-1 PN10
** PN 10 : nous consulter
** PN 10: consult us

ANSI = ASME B16.5 Class 150

CLAPET
Check valve

SERIE 3317



N° Fiche produit - Product sheet
TDS-CHECK-3307

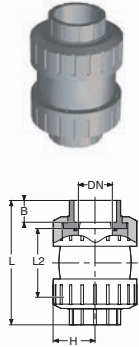

CLAPET ANTI-RETOUR PVC-C À BILLE, DOUBLE UNION, EMBOUTS PVC-C FEMELLES MÉTRIQUES
PVC-C Ball check valve, double union, PVC-C metric sockets

DIMENSIONS Dimensions							RÉFÉRENCE Product code		PN bar
d mm	DN mm	G inch	L mm	L2 mm	H mm	B mm	EPDM	FPM	
20	15	1/2"	105	53	27	17	3317-00BBE	3317-00BBV	10
25	20	3/4"	119	60.5	32	18.5	3317-01BBE	3317-01BBV	10
32	25	1"	136	68	36.5	21	3317-02BBE	3317-02BBV	10
40	32	1 1/4"	176	85	49	26	3317-03BBE	3317-03BBV	10
50	40	1 1/2"	176	85	49	34	3317-04BBE	3317-04BBV	10
63	50	2"	196	106	60.5	38	3317-05BBE	3317-05BBV	10
75	65	2 1/2"	222	108	75	45	3317-06BBE	3317-06BBV	7
90	80	3"	274	147	92	51	3317-07BBE	3317-07BBV	7
110	100	4"	361	211	99.5	61	3317-08BBE	3317-08BBV	7

Montage vertical uniquement
Vertical fitting only

CLAPET ANTI-RETOUR PVC-C À BILLE, DOUBLE UNION, EMBOUTS PVC-C TARAUDÉS PAS DU GAZ CYLINDRIQUE
PVC-C Ball check valve, double union, PVC-C BSP threaded sockets

DIMENSIONS Dimensions							RÉFÉRENCE Product code		PN bar
d mm	DN mm	G inch	L mm	L2 mm	H mm	B mm	EPDM	FPM	
20	15	1/2"	105	53	27	22.5	3317-00AAE	3317-00AAV	10
25	20	3/4"	119	60.5	32	25.5	3317-01AAE	3317-01AAV	10
32	25	1"	136	68	36.5	29	3317-02AAE	3317-02AAV	10
40	32	1 1/4"	176	85	49	35	3317-03AAE	3317-03AAV	10
50	40	1 1/2"	176	85	49	36	3317-04AAE	3317-04AAV	10
63	50	2"	196	106	60.5	38	3317-05AAE	3317-05AAV	10
75	65	2 1/2"	222	108	75	45	3317-06AAE	3317-06AAV	7
90	80	3"	274	147	92	48.5	3317-07AAE	3317-07AAV	7
110	100	4"	362	211	99.5	53.5	3317-08AAE	3317-08AAV	7

Montage vertical uniquement
Vertical fitting only

CLAPET ANTI-RETOUR PVC-C À BILLE, DOUBLE UNION, À BRIDES
PVC-C Ball check valve, double union, with flanges

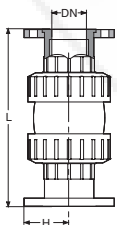

DIMENSIONS Dimensions					RÉFÉRENCE (BRIDES DIN*) Product code (DIN flanges*)		RÉFÉRENCE (BRIDES ANSI*) Product code (ANSI flanges*)		PN bar
d mm	DN mm	G inch	L mm	H mm	EPDM	FPM	EPDM	FPM	
20	15	1/2"	145	47.5	3317-00FFE	3317-00FFV	3317-00GGE	3317-00GGV	10
25	20	3/4"	159	52.5	3317-01FFE	3317-01FFV	3317-01GGE	3317-01GGV	10
32	25	1"	184	57.5	3317-02FFE	3317-02FFV	3317-02GGE	3317-02GGV	10
40	32	1 1/4"	220	70	3317-03FFE	3317-03FFV	3317-03GGE	3317-03GGV	10
50	40	1 1/2"	220	75	3317-04FFE	3317-04FFV	3317-04GGE	3317-04GGV	10
63	50	2"	248	82.5	3317-05FFE	3317-05FFV	3317-05GGE	3317-05GGV	10
75	65	2 1/2"	276	92.5	3317-06FFE	3317-06FFV	3317-06GGE	3317-06GGV	7
90	80	3"	340	100	3317-07FFE	3317-07FFV	3317-07GGE	3317-07GGV	7
110	100	4"	422	110	3317-08FFE	3317-08FFV	3317-08GGE	3317-08GGV	7

* DIN = EN1092-1 PN10
Montage vertical uniquement
Vertical fitting only

ANSI = ASME B16.5 Class 150

PP-H

quotes@tfpes.co.uk

PP-H

Tel: 01626 201092

46

www.safi-valves.com



ROBINETTERIE INDUSTRIELLE - Industrial valves

PP-H

Le polypropylène (PP) est un thermoplastique semi-cristallin, du groupe des polyoléfines. Ses bonnes propriétés mécaniques et chimiques en font un des matériaux les plus répandus dans la robinetterie plastique.

On compte trois grandes familles de polypropylène :

- Type 1 : PP-H (Homopolymère)
- Type 2 : PP-B (Block-copolymère)
- Type 3 : PP-R (Random-copolymère)

Les robinets SAFI utilisent exclusivement le PP de Type 1.

Le polypropylène présente une bonne stabilité thermique (par rapport au PVC-U notamment) entre 0°C et +90°C, ainsi qu'une bonne résistance aux chocs. La nature non polarisée du PP lui donne une bonne résistance chimique.

Il résiste notamment aux sels, acides et alcalis et à de nombreux solvants organiques. Le polypropylène est non-toxique et se soude facilement.

Polypropylene (PP) is a thermoplastic partially crystalline, from the polyolefin group. Due to its good mechanical and chemical properties, it is one of the most widely used materials in the plastic valve industry.

There are three main polypropylene families:

- Type 1: PP-H (Homopolymer)
- Type 2: PP-B (Block-copolymer)
- Type 3: PP-R (Random-copolymer)

SAFI's valves exclusively use Type 1 PP.

The polypropylene presents a good thermal stability from 0°C up to 90°C (particularly compared to PVC-U), as well as a good shock resistance. PP's non-polarized nature provides a good chemical resistance.

It particularly resists to salts, acids and alkalis and numerous organic solvents. The polypropylene is non-toxic and can be easily welded.

0°C → +90°C

TEMPÉRATURE DE SERVICE
Operating temperature

ROBINET À TOURNANT SPHÉRIQUE

Ball valve

SERIE 3150



N° Fiche produit - Product sheet
TDS-BALL-3101

STANDARDS &
APPROVALS

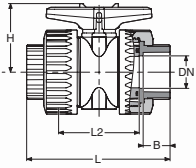

ROBINET PP-H À TOURNANT SPHÉRIQUE 2 VOIES, DOUBLE UNION, EMBOUTS PP-H FEMELLES MÉTRIQUES

2-way PP-H ball valve, double union, PP-H metric sockets

DIMENSIONS Dimensions							RÉFÉRENCE Product code		
d	DN	G	L	L2	H	B	EPDM	FPM	PN
mm	mm	inch	mm	mm	mm	mm			bar
20	15	1/2"	112	64	48	14.5	3150-00CCE	3150-00CCV	10
25	20	3/4"	122	64	62	17	3150-01CCE	3150-01CCV	10
32	25	1"	143	69	66	22	3150-02CCE	3150-02CCV	10
40	32	1"1/4	177	76.5	83	22	3150-03CCE	3150-03CCV	10
50	40	1"1/2	177.5	93	83	26	3150-04CCE	3150-04CCV	10
63	50	2"	200	114	94	31	3150-05CCE	3150-05CCV	10
75	65	2"1/2	225	116.5	147	31	3150-06CCE	3150-06CCV	7
90	80	3"	270	149	163	34.5	3150-07CCE	3150-07CCV	7
110	100	4"	320	175	170	45	3150-08CCE	3150-08CCV	7

ROBINET PP-H À TOURNANT SPHÉRIQUE 2 VOIES, DOUBLE UNION, EMBOUTS PP-H TARAUDÉS PAS DU GAZ CYLINDRIQUE

2-way PP-H ball valve, double union, PP-H BSP threaded sockets

DIMENSIONS Dimensions							RÉFÉRENCE Product code		
d	DN	G	L	L2	H	B	EPDM	FPM	PN
mm	mm	inch	mm	mm	mm	mm			bar
20	15	1/2"	112	64	48	21	3150-00AAE	3150-00AAV	10
25	20	3/4"	122	64	62	24	3150-01AAE	3150-01AAV	10
32	25	1"	140	69	66	27	3150-02AAE	3150-02AAV	10
40	32	1"1/4	178	76.5	83	30.5	3150-03AAE	3150-03AAV	10
50	40	1"1/2	178	93	83	32.5	3150-04AAE	3150-04AAV	10
63	50	2"	200	114	94	35	3150-05AAE	3150-05AAV	10
75	65	2"1/2	225	116.5	147	42	3150-06AAE	3150-06AAV	7
90	80	3"	270	149	163	46.5	3150-07AAE	3150-07AAV	7
110	100	4"	323	175	170	54	3150-08AAE	3150-08AAV	7

OPTIONS série 3150



Autres embouts : consultez la page «fittings»
DN15 à DN50 : cadenasage de série
Other fittings: see page «fittings»
DN15 to DN50 : standard locking

ROBINET À TOURNANT SPHÉRIQUE

Ball valve

SERIE 3150



N° Fiche produit - Product sheet
TDS-BALL-3101

STANDARDS &
APPROVALS



ROBINET PP-H À TOURNANT SPHÉRIQUE 2 VOIES, DOUBLE UNION, À BRIDES

2-way PP-H ball valve, double union, with flanges

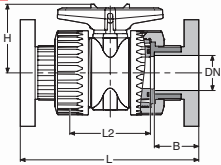

DIMENSIONS							RÉFÉRENCE (BRIDES DIN*)		RÉFÉRENCE (BRIDES ANSI*)		PN bar
Dimensions							Product code (DIN flanges*)		Product code (ANSI flanges*)		
d	DN	G	L	L2	H	B	EPDM	FPM	EPDM	FPM	
20	15	1/2"	153	64	46.5	44.5	3150-00FFE	3150-00FFV	3150-00GGE	3150-00GGV	10
25	20	3/4"	158	64	52.5	46	3150-01FFE	3150-01FFV	3150-01GGE	3150-01GGV	10
32	25	1"	181	69	57	53	3150-02FFE	3150-02FFV	3150-02GGE	3150-02GGV	10
40	32	1"1/4	210	76.5	70	59	3150-03FFE	3150-03FFV	3150-03GGE	3150-03GGV	10
50	40	1"1/2	224	93	74.5	66	3150-04FFE	3150-04FFV	3150-04GGE	3150-04GGV	10
63	50	2"	250	114	82.5	68	3150-05FFE	3150-05FFV	3150-05GGE	3150-05GGV	10
75	65	2"1/2	278	116.5	91	80.5	3150-06FFE	3150-06FFV	3150-06GGE	3150-06GGV	7
90	80	3"	325	149	98	88	3150-07FFE	3150-07FFV	3150-07GGE	3150-07GGV	7
110	100	4"	376	175	110	97.8	3150-08FFE	3150-08FFV	3150-08GGE	3150-08GGV	7

* DIN = EN1092-1 PN10/16

ANSI = ASME B16.5 Class 150

OPTIONS série 3150



Autres embouts : consultez la page «fittings»
DN15 à DN50 : cadenassage de série
Other fittings: see page «fittings»
DN15 to DN50 : standard locking

quotes@tfpes.co.uk

PP-H

ROBINET À MEMBRANE

Diaphragm valve

SERIE 2100



N° Fiche produit - Product sheet
TDS-DIAPH-2300

STANDARDS & APPROVALS



ROBINET PP-H À MEMBRANE À BRIDES

Flanged PP-H diaphragm valve

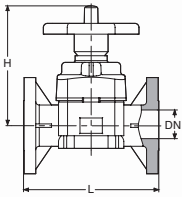

DIMENSIONS Dimensions					RÉFÉRENCE (BRIDES DIN*) Product code (DIN flanges*)			RÉFÉRENCE (BRIDES ANSI*) Product code (ANSI flanges*)			PN bar
d mm	DN mm	G inch	L mm	H mm	EPDM	FPM	PTFE	EPDM	FPM	PTFE	
20	15	1/2"	130	133	2100-00FFE	2100-00FFZ	2100-00FFP	2100-00GGE	2100-00GGZ	2100-00GGP	10
25	20	3/4"	150	133	2100-01FFE	2100-01FFZ	2100-01FFP	2100-01GGE	2100-01GGZ	2100-01GGP	10
32	25	1"	160	133	2100-02FFE	2100-02FFZ	2100-02FFP	2100-02GGE	2100-02GGZ	2100-02GGP	10
40	32	1"1/4"	180	167	2100-03FFE	2100-03FFZ	2100-03FFP	2100-03GGE	2100-03GGZ	2100-03GGP	10
50	40	1"1/2"	200	167	2100-04FFE	2100-04FFZ	2100-04FFP	2100-04GGE	2100-04GGZ	2100-04GGP	10
63	50	2"	230	205	2100-05FFE	2100-05FFZ	2100-05FFP	2100-05GGE	2100-05GGZ	2100-05GGP	10

* DIN = EN1092-1 PN10/16

ANSI = ASME B16.5 Class 150



ROBINET PP-H À MEMBRANE, DOUBLE UNION, EMBOUTS PP-H FEMELLES MÉTRIQUES

PP-H diaphragm valve, double union, PP-H metric sockets

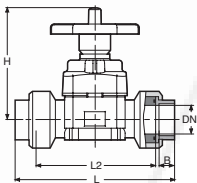

DIMENSIONS Dimensions							RÉFÉRENCE Product code			PN bar
d mm	DN mm	G inch	L mm	L2 mm	H mm	B mm	EPDM	FPM	PTFE	
20	15	1/2"	177	135	133	17	2100-00CCE	2100-00CCZ	2100-00CCP	10
25	20	3/4"	177	132	133	18	2100-01CCE	2100-01CCZ	2100-01CCP	10
32	25	1"	182	134	133	20	2100-02CCE	2100-02CCZ	2100-02CCP	10
40	32	1"1/4"	220	166	167	22	2100-03CCE	2100-03CCZ	2100-03CCP	10
50	40	1"1/2"	238	177	167	25	2100-04CCE	2100-04CCZ	2100-04CCP	10
63	50	2"	268	197	205	29,5	2100-05CCE	2100-05CCZ	2100-05CCP	10



ROBINET PP-H À MEMBRANE, SORTIES PP-H MÂLES

PP-H diaphragm valve, PP-H metric spigot outlets

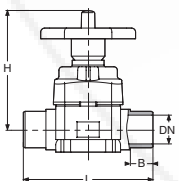

DIMENSIONS Dimensions						RÉFÉRENCE Product code			PN bar
d mm	DN mm	G inch	L mm	H mm	B mm	EPDM	FPM	PTFE	
20	15	1/2"	123	133	16.5	2100-00ZZE	2100-00ZZZ	2100-00ZZP	10
25	20	3/4"	143	133	19.5	2100-01ZZE	2100-01ZZZ	2100-01ZZP	10
32	25	1"	154	133	23.5	2100-02ZZE	2100-02ZZZ	2100-02ZZP	10
40	32	1"1/4"	175	167	27	2100-03ZZE	2100-03ZZZ	2100-03ZZP	10
50	40	1"1/2"	193	167	32	2100-04ZZE	2100-04ZZZ	2100-04ZZP	10
63	50	2"	224	205	39	2100-05ZZE	2100-05ZZZ	2100-05ZZP	10

OPTIONS série 2100



- 2100 devient 2107 avec un actionneur pneumatique DE
2100 becomes 2107 when fitted with a double acting pneumatic actuator
- 2100 devient 2108 avec un actionneur pneumatique SE/NO
2100 becomes 2108 when fitted with failsafe open (NO) pneumatic actuator
- 2100 devient 2109 avec un actionneur pneumatique SE/NF
2100 becomes 2109 when fitted with failsafe closed (NC) pneumatic actuator

ROBINET À MEMBRANE
Diaphragm valve

SERIE 3201



N° Fiche produit - Product sheet
TDS-DIAPH-3200

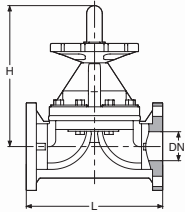

ROBINET PP-H À MEMBRANE À BRIDES
Flanged PP-H diaphragm valve

DIMENSIONS Dimensions					RÉFÉRENCE (BRIDES DIN*) Product code (DIN flanges*)		RÉFÉRENCE (BRIDES ANSI*) Product code (ANSI flanges*)		PN	PN
d	DN	G	L	H	EPDM	PTFE	EPDM	PTFE	bar	bar
mm	mm	inch	mm	mm					EPDM	PTFE
75	65	2"1/2	290	197	3201-06FFE	3201-06FFP	3201-06GGE	3201-06GGP	10	5
90	80	3"	310	293	3201-07FFE	3201-07FFP	3201-07GGE	3201-07GGP	10	5
110	100	4"	350	370	3201-08FFE	3201-08FFP	3201-08GGE	3201-08GGP	10	5
125	125	5"	400	412	3201-09FFE	3201-09FFP	3201-09GGE	3201-09GGP	5	4
160	150	6"	480	471	3201-10FFE	3201-10FFP	3201-10FFE	3201-10FFP	5	4
225	200	8"	600	625	3201-11FFE	3201-11FFP	3201-11GGE	3201-11GGP	3	2
280	250	10"	680	750	3201-12FFE	3201-12FFP	3201-12GGE	3201-12GGP	3	2

* DIN = EN1092-1 PN10 ANSI = ASME B16.5 Class 150

OPTIONS série 3201



quotes@tfpes.co.uk

PP-H

ROBINET À PAPILLON

Butterfly valve

SERIE 3700



N° Fiche produit - Product sheet
TDS-BUTT-3600



ROBINET À PAPILLON, CORPS PP-H, PAPILLON PP-H, MONTAGE WAFER ENTRE BRIDES, COMMANDE PAR POIGNÉE
Butterfly valve, PP-H body, PP-H butterfly, wafer type, with lever handle

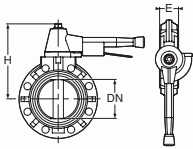

DIMENSIONS					RÉFÉRENCE (BRIDES DIN*)		RÉFÉRENCE (BRIDES ANSI*)		PN
Dimensions					Product code (DIN flanges*)		Product code (ANSI flanges*)		
d	DN	G	H	E	EPDM	FPM	EPDM	FPM	bar
63	50	2"	168	43	3700-05WWE	3700-05WWV	3700A05WWE	3700A05WWV	10
75	65	2"1/2	176	45	3700-06WWE	3700-06WWV	3700A06WWE	3700A06WWV	10
90	80	3"	183	45	3700-07WWE	3700-07WWV (1)	3700A07WWE	3700A07WWV (1)	10
110	100	4"	196	55	3700-08WWE	3700-08WWV (1)	3700A08WWE	3700A08WWV (1)	10
140	125	5"	250	65	3700-09WWE	3700-09WWV	3700A09WWE	3700A09WWV	10
160	150	6"	270	70	3700-10WWE	3700-10WWV (1)	3700-10WWE	3700-10WWV (1)	10
225	200	8"	307	87	3700L11WWE	3700L11WWV	3700AL11WWE	3700AL11WWV	10

* DIN = EN1092-1 PN10/16 ANSI = ASME B16.5 Class 150
(1) possibilité de manchette FPM haute performance (FPM grade F).
(1) possibility of gasket in high performance FPM (F grade).



N° Fiche produit - Product sheet
TDS-BUTT-3600A



ROBINET À PAPILLON, CORPS PP-H, PAPILLON PP-H, MONTAGE WAFER ENTRE BRIDES, COMMANDE PAR RÉDUCTEUR MANUEL
Butterfly valve, PP-H body, PP-H butterfly, wafer type, with handwheel and reduction gearbox

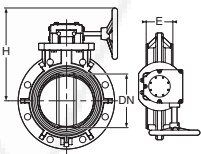

DIMENSIONS					RÉFÉRENCE (BRIDES DIN*)		RÉFÉRENCE (BRIDES ANSI*)		PN
Dimensions					Product code (DIN flanges*)		Product code (ANSI flanges*)		
d	DN	G	H	E	EPDM	FPM	EPDM	FPM	bar
225	200	8"	322	87	3700-11WWE	3700-11WWV	3700A11WWE	3700A11WWV	10
280	250	10"	354	106	3700-12WWE	3700-12WWV	3700A12WWE	3700A12WWV	10
315	300	12"	495	128	3700-13WWE	3700-13WWV	3700A13WWE	3700A13WWV	7
355	350	14"	480	128	3700-14WWE	3700-14WWV	3700A14WWE	3700A14WWV	7
400	400	16"	606	169	3700-15WWE	3700-15WWV	3700A15WWE	3700A15WWV	6
450	450	18"	618	181	3700-16WWE	3700-16WWV	3700A16WWE	3700A16WWV	5
500	500	20"	690	191	3700-17WWE	3700-17WWV	3700A17WWE	3700A17WWV	3.5
630	600	24"	778	209	3700-18WWE	3700-18WWV	3700A18WWE	3700A18WWV	3.5
710	700	28"	879	206	3700-19WWE	3700-19WWV	3700A19WWE	3700A19WWV	1
800	800	32"	965	244	3700-20WWE	3700-20WWV	3700A20WWE	3700A20WWV	1
900	900	36"	1029	245	**	**	**	**	1
1000	1000	40"	1226	301	**	**	**	**	1

* DIN = EN1092-1 PN10 ANSI = ASME B16.5 Class 150
** Nous consulter
** Consult us

OPTIONS série 3700

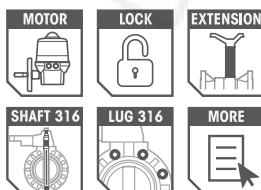

Pour commander un robinet papillon prêt pour motorisation, rajouter la référence ACTUREADY après celle du robinet. Par exemple 3700-05WWE + ACTUREADY
- pour les DN50 à 200 : la poignée crantée est enlevée, la face est dressée et percée
- pour les DN250 et supérieurs : le réducteur est enlevé
Les kits de motorisation pour robinets papillons se trouvent en page 170 du catalogue.

To order a butterfly valve ready for actuation, please add the code ACTUREADY after the code of the valve. For example 3700-05WWE + ACTUREADY
- for DN50 to 200 : the handled is removed, the face is machined and drilled
- for DN250 and higher : the gearbox is removed
The actuation kits for butterfly valves can be found on page 170 of the catalog.

ROBINET À PAPILLON
Butterfly valve

SERIE 5150/5154



N° Fiche produit - Product sheet
TDS-DAMP-5150

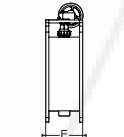
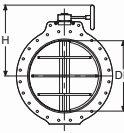
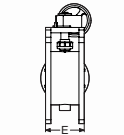
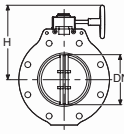

REGISTRE DE VENTILATION, CORPS PP-H, PAPILLON PP-H, À BRIDES, COMMANDE PAR RÉDUCTEUR MANUEL
Flanged damper, PP-H body, PP-H butterfly, with handwheel and reduction gearbox

DIMENSIONS Dimensions				RÉFÉRENCE (BRIDES DIN*) Product code (DIN flanges*)			RÉFÉRENCE (BRIDES ANSI*) Product code (ANSI flanges*)		
DN mm	G inch	H mm	E mm	Etanchéité plastique/ plastique	Etanchéité relative EPDM	Etanchéité relative FPM	Etanchéité plastique/ plastique	Etanchéité relative EPDM	Etanchéité relative FPM
150	6"	244	145	5150-10FFP	**	**	5150-10GGP	**	**
200	8"	279	145	5150-11FFP	**	**	5150-11GGP	**	**
250	10"	309	150	5150-12FFP	**	**	5150-12GGP	**	**
300	12"	349	150	5150-13FFP	**	**	5150-13GGP	**	**
350	14"	379	150	5150-14FFP	**	**	5150-14GGP	**	**
400	16"	419	175	5150-15FFP	5154-15FFE	5154-15FFV	5150-15GGP	5154-15GGE	5154-15GGV
450	18"	449	175	5150-16FFP	5154-16FFE	5154-16FFV	5150-16GGP	5154-16GGE	5154-16GGV
500	20"	459	300	5150-17FFP	5154-17FFE	5154-17FFV	5150-17GGP	5154-17GGE	5154-17GGV
600	24"	529	300	5150-18FFP	5154-18FFE	5154-18FFV	5150-18GGP	5154-18GGE	5154-18GGV
700	28"	589	300	5150-19FFP	5154-19FFE	5154-19FFV	5150-19GGP	5154-19GGE	5154-19GGV
800	32"	639	300	5150-20FFP	5154-20FFE	5154-20FFV	5150-20GGP	5154-20GGE	5154-20GGV
900	36"	689	300	5150-21FFP	5154-21FFE	5154-21FFV	5150-21GGP	5154-21GGE	5154-21GGV
1000	40"	759	300	5150-22FFP	5154-22FFE	5154-22FFV	5150-22GGP	5154-22GGE	5154-22GGV
1100	44"	809	300	5150-23FFP	5154-23FFE	5154-23FFV	5150-23GGP	5154-23GGE	5154-23GGV
1200	48"	869	300	5150-24FFP	5154-24FFE	5154-24FFV	5150-24GGP	5154-24GGE	5154-24GGV
1300	52"	929	300	5150-25FFP	5154-25FFE	5154-25FFV	5150-25GGP	5154-25GGE	5154-25GGV
1400	56"	1010	300	5150-26FFP	5154-26FFE	5154-26FFV	5150-26GGP	5154-26GGE	5154-26GGV
1500	60"	1060	400	5150-27FFP	5154-27FFE	5154-27FFV	5150-27GGP	5154-27GGE	5154-27GGV
1600	64"	1110	400	5150-28FFP	5154-28FFE	5154-28FFV	5150-28GGP	5154-28GGE	5154-28GGV
1700	68"	1160	400	5150-29FFP	5154-29FFE	5154-29FFV	5150-29GGP	5154-29GGE	5154-29GGV
1800	72"	1210	400	5150-30FFP	5154-30FFE	5154-30FFV	5150-30GGP	5154-30GGE	5154-30GGV

* DIN = EN1092-1 PN10

ANSI = ASME B16.5 Class 150 (DN≤600) puis AWWA C207 (DN>700)

** Nous consulter

** Consult us

Robinet avec axe nu : 5150 devient 5151, 5154 devient 5155

Valve with free shaft : 5150 becomes 5151, 5154 becomes 5155

OPTIONS série 5150/5154



Les registres à étanchéité relative ont une étanchéité Classe C-2 ou supérieure selon EN 1751. Voir notre fiche produit.

Our dampers with relative airtightness comply with requirement of Class C-2 of EN 1751. See our product sheet for more details.

quotes@tipes.co.uk

PP-H

CLAPET
Check valve

SERIE 2054



N° Fiche produit - Product sheet
TDS-CHECK-2054

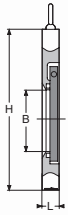

CLAPET PP-H À BATTANT, MONTAGE WAFER ENTRE BRIDES
Wafer PP-H swing check valve

d	DN	DIMENSIONS					RÉFÉRENCE (BRIDES DIN*)		RÉFÉRENCE (BRIDES ANSI*)		PN bar
		Dimensions					Product code (DIN flanges*)		Product code (ANSI flanges*)		
		G	L	H	H	B	EPDM	FPM	EPDM	FPM	
mm	mm	inch	mm	mm	mm	mm					
63	50	2"	23	109	101	28	2054D05RPE	2054D05RPV	2054A05RPE	2054A05RPV	10
75	65	2 1/2"	23	130	120	32	2054D06RPE	2054D06RPV	2054A06RPE	2054A06RPV	10
90	80	3"	23	144	132	40	2054D07RPE	2054D07RPV	2054A07RPE	2054A07RPV	10
110	100	4"	23	164	170	63	2054D08RPE	2054D08RPV	2054A08RPE	2054A08RPV	10
140	125	5"	25	194	193	77	2054D09RPE	2054D09RPV	2054A09RPE	2054A09RPV	10
160	150	6"	25	220	220	90	2054D10RPE	2054D10RPV	2054A10RPE	2054A10RPV	10
225	200	8"	35	275	275	126	2054D11RTE	2054D11RTV	2054A11RTE	2054A11RTV	6
280	250	10"	35	330	336	140	2054D12RTE	2054D12RTV	2054A12RTE	2054A12RTV	5
315	300	12"	40	380	406	176	2054D13RTE	2054D13RTV	2054A13RTE	2054A13RTV	4
355	350	14"	50	422	447	250	2054D14RTE	2054D14RTV	2054A14RTE	2054A14RTV	3
400	400	16"	50	470	511	287	2054D15RTE	2054D15RTV	2054A15RTE	2054A15RTV	3
450	450	18"	60	538	544	339	2054D16RTE	2054D16RTV	2054A16RTE	2054A16RTV	2

* DIN = EN1092-1 PN10

ANSI = ASME B16.5 Class 150

Axe en PVDF jusqu'au DN150 inclus, puis axe en titane.
PVDF flap pin from DN50 to DN150. Titanium flap pin for DN>150.

SERIE 3304



N° Fiche produit - Product sheet
TDS-CHECK-3300

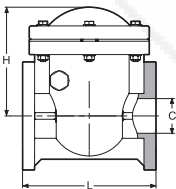

CLAPET PP-H À BATTANT À BRIDES
Flanged PP-H swing check valve

d	DN	DIMENSIONS				RÉFÉRENCE (BRIDES DIN*)		RÉFÉRENCE (BRIDES ANSI*)		PN** bar
		Dimensions				Product code (DIN flanges*)		Product code (ANSI flanges*)		
		G	L	H	C	EPDM	FPM	EPDM	FPM	
mm	mm	inch	mm	mm	mm					
20	15	1/2"	160	129	25	3304-00FFE	3304-00FFV	3304-00GGE	3304-00GGV	6
25	20	3/4"	160	129	25	3304-01FFE	3304-01FFV	3304-01GGE	3304-01GGV	6
32	25	1"	160	129	25	3304-02FFE	3304-02FFV	3304-02GGE	3304-02GGV	6
40	32	1 1/4"	180	141	41	3304-03FFE	3304-03FFV	3304-03GGE	3304-03GGV	6
50	40	1 1/2"	180	141	41	3304-04FFE	3304-04FFV	3304-04GGE	3304-04GGV	6
63	50	2"	200	165	52	3304-05FFE	3304-05FFV	3304-05GGE	3304-05GGV	6
75	65	2 1/2"	260	180	80	3304-06FFE	3304-06FFV	3304-06GGE	3304-06GGV	6
90	80	3"	260	180	80	3304-07FFE	3304-07FFV	3304-07GGE	3304-07GGV	6
110	100	4"	300	216	100	3304-08FFE	3304-08FFV	3304-08GGE	3304-08GGV	5
140	125	5"	350	239.5	125	3304-09FFE	3304-09FFV	3304-09GGE	3304-09GGV	5
160	150	6"	400	273	150	3304-10FFE	3304-10FFV	3304-10GGE	3304-10GGV	4
225	200	8"	500	310	200	3304-11FFE	3304-11FFV	3304-11GGE	3304-11GGV	3

* DIN = EN1092-1 PN10 ANSI = ASME B16.5 Class 150

** PN 10 : nous consulter

** PN 10: consult us

CLAPET
Check valve

SERIE 3309



N° Fiche produit - Product sheet
TDS-CHECK-3307

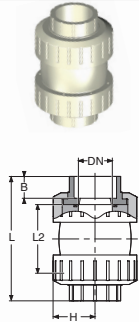

CLAPET ANTI-RETOUR PP-H À BILLE, DOUBLE UNION, EMBOUTS PP-H FEMELLES MÉTRIQUES
PP-H Ball check valve, double union, PP-H metric sockets

DIMENSIONS Dimensions							RÉFÉRENCE Product code		
d	DN	G	L	L2	H	B	EPDM	FPM	PN
mm	mm	inch	mm	mm	mm	mm			bar
20	15	1/2"	102	52	26.5	15.5	3309-00CCE	3309-00CCV	7
25	20	3/4"	116	59.5	31.5	17	3309-01CCE	3309-01CCV	7
32	25	1"	134	67	36.5	20	3309-02CCE	3309-02CCV	7
40	32	1"1/4	172	84	49	22	3309-03CCE	3309-03CCV	7
50	40	1"1/2	172	84	49	25	3309-04CCE	3309-04CCV	7
63	50	2"	193	105	59.5	28.5	3309-05CCE	3309-05CCV	7
75	65	2"1/2	226	112	75	44	3309-06CCE	3309-06CCV	5
90	80	3"	274	147	92	50	3309-07CCE	3309-07CCV	5
110	100	4"	367	217	99.5	61	3309-08CCE	3309-08CCV	5

Montage vertical uniquement
Vertical fitting only

CLAPET ANTI-RETOUR PP-H À BILLE, DOUBLE UNION, EMBOUTS PP-H TARAUDÉS PAS DU GAZ CYLINDRIQUE
PP-H Ball check valve, double union, PP-H BSP threaded sockets

DIMENSIONS Dimensions							RÉFÉRENCE Product code		
d	DN	G	L	L2	H	B	EPDM	FPM	PN
mm	mm	inch	mm	mm	mm	mm			bar
20	15	1/2"	102	52	26.5	21	3309-00AAE	3309-00AAV	7
25	20	3/4"	116	59.5	31.5	24	3309-01AAE	3309-01AAV	7
32	25	1"	134	67	36.5	27	3309-02AAE	3309-02AAV	7
40	32	1"1/4	171	84	48	30.5	3309-03AAE	3309-03AAV	7
50	40	1"1/2	171	84	49	32.5	3309-04AAE	3309-04AAV	7
63	50	2"	192	105	59.5	35	3309-05AAE	3309-05AAV	7
75	65	2"1/2	226	112	75	44	3309-06AAE	3309-06AAV	5
90	80	3"	274	147	92	50	3309-07AAE	3309-07AAV	5
110	100	4"	367	217	99.5	61	3309-08AAE	3309-08AAV	5

Montage vertical uniquement
Vertical fitting only

CLAPET ANTI-RETOUR PP-H À BILLE, DOUBLE UNION, À BRIDES
PP-H Ball check valve, double union, with flanges

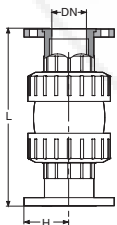

DIMENSIONS Dimensions					RÉFÉRENCE (BRIDES DIN*) Product code (DIN flanges*)		RÉFÉRENCE (BRIDES ANSI*) Product code (ANSI flanges*)		PN bar
d	DN	G	L	H	EPDM	FPM	EPDM	FPM	
mm	mm	inch	mm	mm					
20	15	1/2"	141	46.5	3309-00FFE	3309-00FFV	3309-00GGE	3309-00GGV	7
25	20	3/4"	157	52.5	3309-01FFE	3309-01FFV	3309-01GGE	3309-01GGV	7
32	25	1"	173	57	3309-02FFE	3309-02FFV	3309-02GGE	3309-02GGV	7
40	32	1"1/4	202	70	3309-03FFE	3309-03FFV	3309-03GGE	3309-03GGV	7
50	40	1"1/2	216	74.5	3309-04FFE	3309-04FFV	3309-04GGE	3309-04GGV	7
63	50	2"	242	82.5	3309-05FFE	3309-05FFV	3309-05GGE	3309-05GGV	7
75	65	2"1/2	284	91	3309-06FFE	3309-06FFV	3309-06GGE	3309-06GGV	5
90	80	3"	331	98	3309-07FFE	3309-07FFV	3309-07GGE	3309-07GGV	5
110	100	4"	434	110	3309-08FFE	3309-08FFV	3309-08GGE	3309-08GGV	5

* DIN = EN1092-1 PN10/16
Montage vertical uniquement
Vertical fitting only

ANSI = ASME B16.5 Class 150

FILTRE
Strainer

SERIE 4660



N° Fiche produit - Product sheet
TDS-INCL-4640

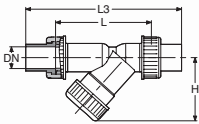

FILTRE EN Y EN PP-H, MAILLE DE 0.5 MM, DOUBLE UNION, EMBOUTS PP-H MÂLES
Y strainer in PP-H, mesh size 0.5 mm, double union, PP-H metric spigots

DIMENSIONS Dimensions						RÉFÉRENCE Product code		
d	DN	G	L	L3	H	EPDM	FPM	PN
mm	mm	inch	mm	mm	mm			bar
20	15	1/2"	130	238	75	4660-00IIE05T	4660-00IIV05T	10
25	20	3/4"	150	264	80	4660-01IIE05T	4660-01IIV05T	10
32	25	1"	160	280	90	4660-02IIE05T	4660-02IIV05T	10
40	32	1 1/4"	180	306	110	4660-03IIE05T	4660-03IIV05T	10
50	40	1 1/2"	200	332	128	4660-04IIE05T	4660-04IIV05T	10
63	50	2"	230	368	150	4660-05IIE05T	4660-05IIV05T	10

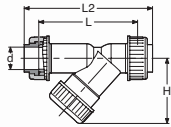

FILTRE EN Y EN PP-H, MAILLE DE 0.5 MM, DOUBLE UNION, EMBOUTS PP-H FEMELLES
Y strainer in PP-H, mesh size 0.5 mm, double union, PP-H metric sockets

DIMENSIONS Dimensions						RÉFÉRENCE Product code		
d	DN	G	L	L2	H	EPDM	FPM	PN
mm	mm	inch	mm	mm	mm			bar
20	15	1/2"	130	168	75	4660-00CCE05T	4660-00CCV05T	10
25	20	3/4"	150	192	80	4660-01CCE05T	4660-01CCV05T	10
32	25	1"	160	206	90	4660-02CCE05T	4660-02CCV05T	10
40	32	1 1/4"	180	230	110	4660-03CCE05T	4660-03CCV05T	10
50	40	1 1/2"	200	256	128	4660-04CCE05T	4660-04CCV05T	10
63	50	2"	230	294	150	4660-05CCE05T	4660-05CCV05T	10

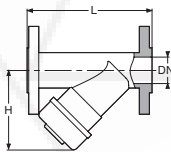

FILTRE EN Y EN PP-H, MAILLE DE 0.5 MM, À BRIDES DIN*
Y strainer in PP-H, mesh size 0.5 mm, with DIN* flanges

DIMENSIONS Dimensions					RÉFÉRENCE Product code		
d	DN	G	L	H	EPDM	FPM	PN
mm	mm	inch	mm	mm			bar
20	15	1/2"	130	75	4660-00FFE05T	4660-00FFV05T	10
25	20	3/4"	150	80	4660-01FFE05T	4660-01FFV05T	10
32	25	1"	160	90	4660-02FFE05T	4660-02FFV05T	10
40	32	1 1/4"	180	110	4660-03FFE05T	4660-03FFV05T	10
50	40	1 1/2"	200	128	4660-04FFE05T	4660-04FFV05T	10
63	50	2"	230	150	4660-05FFE05T	4660-05FFV05T	10

* DIN = EN1092-1 PN10/16

- Autre taille de maille, nous consulter.
- Perçage de bride ANSI/ASME B16.5 Class 150, nous consulter.
- Please contact us for other mesh size.
- ANSI/ASME B16.5 Class 150 drilling, contact us.

FILTRE
Strainer

SERIE 4660



N° Fiche produit - Product sheet
TDS-INCL-4640A

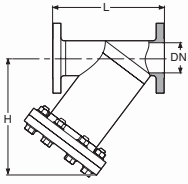

FILTRE EN Y EN PP-H, MAILLE DE 2.0 MM, À BRIDES DIN*
Y strainer in PP-H, mesh size 2.0 mm, with DIN* flanges

DIMENSIONS Dimensions					RÉFÉRENCE Product code		
d	DN	G	L	H	EPDM	FPM	PN
mm	mm	inch	mm	mm			bar
75	65	2"1/2	370	260	4660-06FFE20T	4660-06FFV20T	6
90	80	3"	410	275	4660-07FFE20T	4660-07FFV20T	6
110	100	4"	490	325	4660-08FFE20T	4660-08FFV20T	6
140	125	5"	550	380	4660-09FFE20T	4660-09FFV20T	6
160	150	6"	600	430	4660-10FFE20T	4660-10FFV20T	4
225	200	8"	700	550	4660-11FFE20T	4660-11FFV20T	4
280	250	10"	820	620	4660-12FFE20T	4660-12FFV20T	4

* DIN = EN1092-1 PN10/16

- Autre taille de maille, nous consulter.
- Perçage de bride ANSI/ASME B16.5 Class 150, nous consulter.
- Please contact us for other mesh size.
- ANSI/ASME B16.5 Class 150 drilling, contact us.

quotes@tfpes.co.uk

PP-H

FILTRE
Strainer

SERIE 4570



N° Fiche produit - Product sheet
TDS-INCL-4570

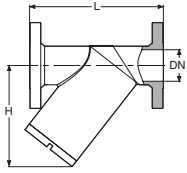

DN65 à DN80

FILTRE EN Y EN PP-H, MAILLE EN PP-H DE 0.4 MM, CONNEXIONS À BRIDES

Y strainer in PP-H, mesh size 0.4 mm, with flanges

DIMENSIONS Dimensions					RÉFÉRENCE (BRIDES DIN*) Product code (DIN flanges*)		RÉFÉRENCE (BRIDES ANSI*) Product code (ANSI flanges*)		PN bar
d mm	DN mm	G inch	L mm	H mm	EPDM	FPM	EPDM	FPM	
75	65	2"1/2	290	236	4570-06FFE04P	4570-06FFV04P	4570-06GGE04P	4570-06GGV04P	10
90	80	3"	310	236	4570-07FFE04P	4570-07FFV04P	4570-07GGE04P	4570-07GGV04P	7
110	100	4"	350	368	4570-08FFE04P	4570-08FFV04P	4570-08GGE04P	4570-08GGV04P	6
140	125	5"	400	356	4570-09FFE04P	4570-09FFV04P	4570-09GGE04P	4570-09GGV04P	5
160	150	6"	480	412	4570-10FFE04P	4570-10FFV04P	4570-10FFE04P	4570-10FFV04P	3
225	200	8"	600	531	4570-11FFE04P	4570-11FFV04P	4570-11GGE04P	4570-11GGV04P	3

* DIN = EN1092-1 PN10

ANSI = ASME B16.5 Class 150

FILTRE EN Y EN PP-H, MAILLE EN PP-H DE 0.8 MM, À BRIDES

Y strainer in PP-H, mesh size 0.8 mm, with flanges

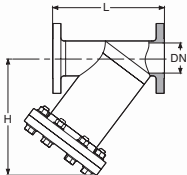

DN100 à DN200

DIMENSIONS Dimensions					RÉFÉRENCE (BRIDES DIN*) Product code (DIN flanges*)		RÉFÉRENCE (BRIDES ANSI*) Product code (ANSI flanges*)		PN bar
d mm	DN mm	G inch	L mm	H mm	EPDM	FPM	EPDM	FPM	
75	65	2"1/2	290	236	4570-06FFE08P	4570-06FFV08P	4570-06GGE08P	4570-06GGV08P	10
90	80	3"	310	236	4570-07FFE08P	4570-07FFV08P	4570-07GGE08P	4570-07GGV08P	7
110	100	4"	350	368	4570-08FFE08P	4570-08FFV08P	4570-08GGE08P	4570-08GGV08P	6
140	125	5"	400	356	4570-09FFE08P	4570-09FFV08P	4570-09GGE08P	4570-09GGV08P	5
160	150	6"	480	412	4570-10FFE08P	4570-10FFV08P	4570-10FFE08P	4570-10FFV08P	3
225	200	8"	600	531	4570-11FFE08P	4570-11FFV08P	4570-11GGE08P	4570-11GGV08P	3

* DIN = EN1092-1 PN10

ANSI = ASME B16.5 Class 150

FILTRE EN Y EN PP-H, MAILLE EN PP-H DE 1.0 MM, À BRIDES

Y strainer in PP-H, mesh size 1.0 mm, with flanges

DIMENSIONS Dimensions					RÉFÉRENCE (BRIDES DIN*) Product code (DIN flanges*)		RÉFÉRENCE (BRIDES ANSI*) Product code (ANSI flanges*)		PN bar
d mm	DN mm	G inch	L mm	H mm	EPDM	FPM	EPDM	FPM	
75	65	2"1/2	290	236	4570-06FFE10P	4570-06FFV10P	4570-06GGE10P	4570-06GGV10P	10
90	80	3"	310	236	4570-07FFE10P	4570-07FFV10P	4570-07GGE10P	4570-07GGV10P	7
110	100	4"	350	368	4570-08FFE10P	4570-08FFV10P	4570-08GGE10P	4570-08GGV10P	6
140	125	5"	400	356	4570-09FFE10P	4570-09FFV10P	4570-09GGE10P	4570-09GGV10P	5
160	150	6"	480	412	4570-10FFE10P	4570-10FFV10P	4570-10FFE10P	4570-10FFV10P	3
225	200	8"	600	531	4570-11FFE10P	4570-11FFV10P	4570-11GGE10P	4570-11GGV10P	3

* DIN = EN1092-1 PN10

ANSI = ASME B16.5 Class 150

OPTIONS série 4570



Autre taille de maille, nous consulter
Please contact us for other mesh size

FILTRE
Strainer

SERIE 4570



N° Fiche produit - Product sheet
TDS-INCL-4570

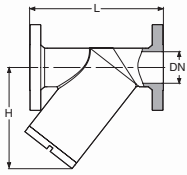

DN65 à DN80

FILTRE EN Y EN PP-H, MAILLE EN ETFE DE 0.4 MM, À BRIDES

Y strainer in PP-H, mesh size 0.4 mm (ETFE), with flanges

DIMENSIONS Dimensions					RÉFÉRENCE (BRIDES DIN*) Product code (DIN flanges*)		RÉFÉRENCE (BRIDES ANSI*) Product code (ANSI flanges*)		PN bar
d mm	DN mm	G inch	L mm	H mm	EPDM	FPM	EPDM	FPM	
75	65	2"1/2	290	236	4570-06FFE04T	4570-06FFV04T	4570-06GGE04T	4570-06GGV04T	10
90	80	3"	310	236	4570-07FFE04T	4570-07FFV04T	4570-07GGE04T	4570-07GGV04T	7
110	100	4"	350	368	4570-08FFE04T	4570-08FFV04T	4570-08GGE04T	4570-08GGV04T	6
140	125	5"	400	356	4570-09FFE04T	4570-09FFV04T	4570-09GGE04T	4570-09GGV04T	5
160	150	6"	480	412	4570-10FFE04T	4570-10FFV04T	4570-10FFE04T	4570-10FFV04T	3
225	200	8"	600	531	4570-11FFE04T	4570-11FFV04T	4570-11GGE04T	4570-11GGV04T	3

* DIN = EN1092-1 PN10

ANSI = ASME B1.6.5 Class 150

FILTRE EN Y EN PP-H, MAILLE EN ETFE DE 0.8 MM, À BRIDES

Y strainer in PP-H, mesh size 0.8 mm (ETFE), with flanges

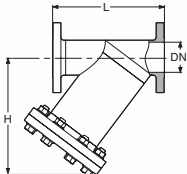

DN100 à DN200

DIMENSIONS Dimensions					RÉFÉRENCE (BRIDES DIN*) Product code (DIN flanges*)		RÉFÉRENCE (BRIDES ANSI*) Product code (ANSI flanges*)		PN bar
d mm	DN mm	G inch	L mm	H mm	EPDM	FPM	EPDM	FPM	
75	65	2"1/2	290	236	4570-06FFE08T	4570-06FFV08T	4570-06GGE08T	4570-06GGV08T	10
90	80	3"	310	236	4570-07FFE08T	4570-07FFV08T	4570-07GGE08T	4570-07GGV08T	7
110	100	4"	350	368	4570-08FFE08T	4570-08FFV08T	4570-08GGE08T	4570-08GGV08T	6
140	125	5"	400	356	4570-09FFE08T	4570-09FFV08T	4570-09GGE08T	4570-09GGV08T	5
160	150	6"	480	412	4570-10FFE08T	4570-10FFV08T	4570-10FFE08T	4570-10FFV08T	3
225	200	8"	600	531	4570-11FFE08T	4570-11FFV08T	4570-11GGE08T	4570-11GGV08T	3

* DIN = EN1092-1 PN10

ANSI = ASME B1.6.5 Class 150

FILTRE EN Y EN PP-H, MAILLE EN ETFE DE 1.0 MM, À BRIDES

Y strainer in PP-H, mesh size 1.0 mm (ETFE), with flanges

DIMENSIONS Dimensions					RÉFÉRENCE (BRIDES DIN*) Product code (DIN flanges*)		RÉFÉRENCE (BRIDES ANSI*) Product code (ANSI flanges*)		PN bar
d mm	DN mm	G inch	L mm	H mm	EPDM	FPM	EPDM	FPM	
75	65	2"1/2	290	236	4570-06FFE10T	4570-06FFV10T	4570-06GGE10T	4570-06GGV10T	10
90	80	3"	310	236	4570-07FFE10T	4570-07FFV10T	4570-07GGE10T	4570-07GGV10T	7
110	100	4"	350	368	4570-08FFE10T	4570-08FFV10T	4570-08GGE10T	4570-08GGV10T	6
140	125	5"	400	356	4570-09FFE10T	4570-09FFV10T	4570-09GGE10T	4570-09GGV10T	5
160	150	6"	480	412	4570-10FFE10T	4570-10FFV10T	4570-10FFE10T	4570-10FFV10T	3
225	200	8"	600	531	4570-11FFE10T	4570-11FFV10T	4570-11GGE10T	4570-11GGV10T	3

* DIN = EN1092-1 PN10

ANSI = ASME B1.6.5 Class 150

OPTIONS série 4570



Autre taille de maille, nous consulter
Please contact us for other mesh size

quotes@tipes.co.uk

PP-H

PPGF
quotes@tfpes.co.uk

PPGF

Tel: 01626 201092

www.safi-valves.com



ROBINETTERIE INDUSTRIELLE - Industrial valves

PPGF

Ce polypropylène contient 20 % de fibres de verre borosilicatées de type «C» résistantes chimiquement.

Il a une très bonne résistance mécanique, une grande stabilité dimensionnelle, s'usine facilement et résiste à des températures de -10°C jusqu'à 100°C.

Sa résistance aux UV est améliorée par l'ajout de pigments au carbone et de stabilisateurs aux UV.

This polypropylene contains 20 % of borosilicate glass reinforced of type «C» chemically resistant.

It has a very good mechanical resistance, a good dimensional stability, can be easily machined and it is resistant to temperatures from -10°C up to 100°C.

Its resistance to UV is improved by the addition of carbon pigments and UV stabilizers.

-10°C → +100°C

TEMPÉRATURE DE SERVICE
Operating temperature

ROBINET À TOURNANT SPHÉRIQUE

Ball valve

SERIE 2014



N° Fiche produit - Product sheet
TDS-BALL-2014

STANDARDS & APPROVALS



ROBINET PPGF À TOURNANT SPHÉRIQUE 2 VOIES, COMPACT À BRIDES

2-way PPGF ball valve, flanged compact

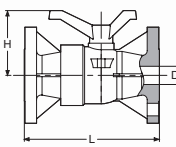

DIMENSIONS					RÉFÉRENCE (BRIDES DIN*)		RÉFÉRENCE (BRIDES ANSI*)		PN
Dimensions					Product code (DIN flanges*)		Product code (ANSI flanges*)		
d	DN	G	L	H	EPDM	FPM	EPDM	FPM	bar
mm	mm	inch	mm	mm					
20	15	1/2"	130	75	2014-00FFE	2014-00FFV	2014-00GGE	2014-00GGV	10
25	20	3/4"	150	75	2014-01FFE	2014-01FFV	2014-01GGE	2014-01GGV	10
32	25	1"	160	95	2014-02FFE	2014-02FFV	2014-02GGE	2014-02GGV	10
40	32	1"1/4	180	99	2014-03FFE	2014-03FFV	2014-03GGE	2014-03GGV	10
50	40	1"1/2	200	106	2014-04FFE	2014-04FFV	2014-04GGE	2014-04GGV	10
63	50	2"	230	111	2014-05FFE	2014-05FFV	2014-05GGE	2014-05GGV	10

* DIN = EN1092-1 PN10/16

ANSI = ASME B16.5 Class 150

OPTIONS série 2014

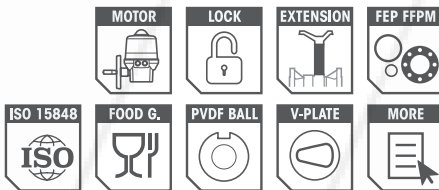

Pour commander un DN65 à brides, commander un robinet série 1003 en DN50 (page 64) avec des ensembles à brides DN65 (page 112).
 Pour commander un robinet avec sphère PVDF, remplacer - par P dans la référence, par exemple 2014P00FFE.
 Pour commander un robinet avec plaquette de régulation, remplacer - par O dans la référence, par exemple 2014O00FFE.
 To order a DN65 flanged ball valve, order a DN50 valve serie 1003 (page 64), with assembly of DN65 flange (page 112).
 To order a valve with a PVDF ball, replace - by P in the product code, for example 2014P00FFE.
 To order a valve with a V plate, replace - by O in the product code, for example 2014O00FFE.

SERIE 1003



N° Fiche produit - Product sheet
TDS-BALL-1003B

STANDARDS & APPROVALS



ROBINET PPGF À TOURNANT SPHÉRIQUE 2 VOIES, CADENASSABLE, SANDWICH À BRIDES

2-way flanged PPGF ball valve, lockable, sandwich construction

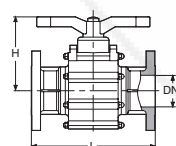

DIMENSIONS					RÉFÉRENCE (BRIDES DIN*)		RÉFÉRENCE (BRIDES ANSI*)		PN
Dimensions					Product code (DIN flanges*)		Product code (ANSI flanges*)		
d	DN	G	L	H	EPDM	FPM	EPDM	FPM	bar
mm	mm	inch	mm	mm					
90	80	3"	310	188	1003-27FFE	1003-27FFV	1003-27GGE	1003-27GGV	10
110	100	4"	350	188	1003-28FFE	1003-28FFV	1003-28GGE	1003-28GGV	10

* DIN = EN1092-1 PN10/16

ANSI = ASME B16.5 Class 150

OPTIONS série 1003

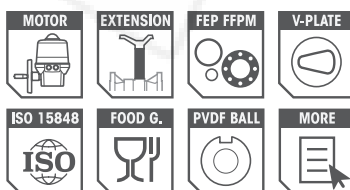

Pour commander un robinet avec sphère PVDF, remplacer - par P dans la référence, par exemple 1003P27FFE.
 Pour commander un robinet avec plaquette de régulation, remplacer - par O dans la référence, par exemple 1003O27FFE.
 To order a valve with a PVDF ball, replace - by P in the product code, for example 1003P27FFE.
 To order a valve with a V plate, replace - by O in the product code, for example 1003O27FFE.

ROBINET À TOURNANT SPHÉRIQUE

Ball valve

SERIE 2008



N° Fiche produit - Product sheet
TDS-BALL-2008

STANDARDS & APPROVALS

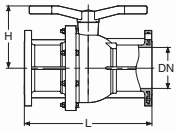

ROBINET PPGF À TOURNANT SPHÉRIQUE 2 VOIES, COMPACT À BRIDES DIN/ANSI*

2-way PPGF ball valve, flanged compact with DIN/ANSI* flanges

DIMENSIONS					RÉFÉRENCE (BRIDES DIN/ANSI*)		
Dimensions					Product code (DIN/ANSI flanges*)		
d	DN	G	L	H	EPDM	FPM	PN
mm	mm	inch	mm	mm			bar
160	150	6"	480	235	2008-09FFE	2008-09FFV	10

* DIN = EN1092-1 PN10/16

ANSI = ASME B16.5 Class 150

OPTIONS série 2008

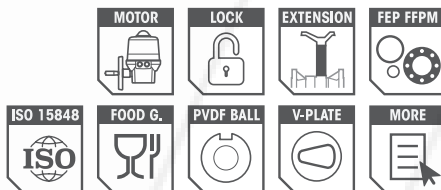

Pour commander un robinet avec sphère PVDF, remplacer - par P dans la référence, par exemple 2008P09FFE.
 Pour commander un robinet avec plaquette de régulation, remplacer - par O dans la référence, par exemple 2008O09FFE.
 To order a valve with a PVDF ball, replace - by P in the product code, for example 2008P09FFE.
 To order a valve with a V plate, replace - by O in the product code, for example 2008O09FFE.

quotes@tfpes.co.uk

PPGF

ROBINET À TOURNANT SPHÉRIQUE

Ball valve

SERIE 1003



N° Fiche produit - Product sheet
TDS-BALL-1003

STANDARDS & APPROVALS

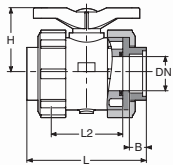

ROBINET PPGF À TOURNANT SPHÉRIQUE 2 VOIES, DOUBLE UNION, EMBOUTS PPGF TARAUDÉS PAS DU GAZ CYLINDRIQUE

2-way PPGF ball valve, double union, BSP threaded PPGF sockets

DIMENSIONS Dimensions						RÉFÉRENCE Product code		
d	DN	G	L	H	B	EPDM	FPM	PN
mm	mm	inch	mm	mm	mm			bar
20	15	1/2"	134	75	17.5	1003-10AAE	1003-10AAV	10
25	20	3/4"	140	75	20.5	1003-11AAE	1003-11AAV	10
32	25	1"	136	78	23.5	1003-02AAE	1003-02AAV	10
40	32	1"1/4	152	83	27.5	1003-03AAE	1003-03AAV	10
50	40	1"1/2	164	89	24.5	1003-04AAE	1003-04AAV	10
63	50	2"	177	95	24.5	1003-05AAE	1003-05AAV	10

ROBINET PPGF À TOURNANT SPHÉRIQUE 2 VOIES, DOUBLE UNION, EMBOUTS PP-H FEMELLES MÉTRIQUES

2-way PPGF ball valve, double union, PP-H metric sockets

DIMENSIONS Dimensions						RÉFÉRENCE Product code		
d	DN	G	L	H	B	EPDM	FPM	PN
mm	mm	inch	mm	mm	mm			bar
20	15	1/2"	130	75	17	1003-10CCE	1003-10CCV	10
25	20	3/4"	133	75	18	1003-11CCE	1003-11CCV	10
32	25	1"	129	78	20	1003-02CCE	1003-02CCV	10
40	32	1"1/4	142	83	22	1003-03CCE	1003-03CCV	10
50	40	1"1/2	161	89	25	1003-04CCE	1003-04CCV	10
63	50	2"	180	95	29.5	1003-05CCE	1003-05CCV	10

ROBINET PPGF À TOURNANT SPHÉRIQUE 2 VOIES, DOUBLE UNION, AVEC ÉCROUS ET JOINTS, SANS EMBOUTS

2-way PPGF ball valve, double union, with union nuts and o-rings, without sockets

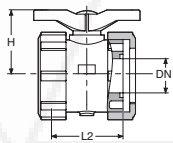

DIMENSIONS Dimensions						RÉFÉRENCE Product code		
d	DN	G	L2	H	B	EPDM	FPM	PN
mm	mm	inch	mm	mm	mm			bar
20	15	1/2"	88	75	-	1003-10XXE	1003-10XXV	10
25	20	3/4"	88	75	-	1003-11XXE	1003-11XXV	10
32	25	1"	80	78	-	1003-02XXE	1003-02XXV	10
40	32	1"1/4	88	83	-	1003-03XXE	1003-03XXV	10
50	40	1"1/2	100	89	-	1003-04XXE	1003-04XXV	10
63	50	2"	108	95	-	1003-05XXE	1003-05XXV	10

OPTIONS série 1003



Pour commander un robinet avec sphère PVDF, remplacer - par P dans la référence, par exemple 1003P10AAE.

To order a valve with a PVDF ball, replace - by P in the product code, for example 1003P10AAE.

ROBINET À TOURNANT SPHÉRIQUE

Ball valve

SERIE 2038



N° Fiche produit - Product sheet
TDS-BALL-1003

STANDARDS &
APPROVALS



ROBINET PPGF À TOURNANT SPHÉRIQUE 2 VOIES, CADENASSABLE, DOUBLE UNION, EMBOUTS PPGF TARAUDÉS PAS DU GAZ CYLINDRIQUE

2-way PPGF ball valve, lockable, double union, BSP threaded PPGF sockets

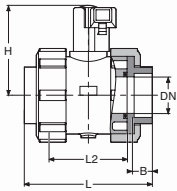

DIMENSIONS Dimensions						RÉFÉRENCE Product code		
d	DN	G	L	H	B	EPDM	FPM	PN
mm	mm	inch	mm	mm	mm			bar
32	25	1"	136	100	23.5	2038-02AAE	2038-02AAV	10
40	32	1"1/4	152	100	27.5	2038-03AAE	2038-03AAV	10
50	40	1"1/2	164	121	24.5	2038-04AAE	2038-04AAV	10
63	50	2"	177	121	24.5	2038-05AAE	2038-05AAV	10

ROBINET PPGF À TOURNANT SPHÉRIQUE 2 VOIES, CADENASSABLE, DOUBLE UNION, EMBOUTS PP-H FEMELLES MÉTRIQUES

2-way PPGF ball valve, lockable, double union, PP-H metric sockets

DIMENSIONS Dimensions						RÉFÉRENCE Product code		
d	DN	G	L	H	B	EPDM	FPM	PN
mm	mm	inch	mm	mm	mm			bar
32	25	1"	129	78	20	2038-02CCE	2038-02CCV	10
40	32	1"1/4	142	83	22	2038-03CCE	2038-03CCV	10
50	40	1"1/2	161	89	25	2038-04CCE	2038-04CCV	10
63	50	2"	180	95	29.5	2038-05CCE	2038-05CCV	10

ROBINET PPGF À TOURNANT SPHÉRIQUE 2 VOIES, CADENASSABLE, DOUBLE UNION, AVEC ÉCROUS ET JOINTS, SANS EMBOUTS

2-way PPGF ball valve, lockable, double union, with union nuts and o-rings, without sockets

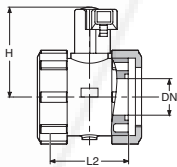

DIMENSIONS Dimensions						RÉFÉRENCE Product code		
d	DN	G	L2	H	B	EPDM	FPM	PN
mm	mm	inch	mm	mm	mm			bar
32	25	1"	80	78	-	2038-02XXE	2038-02XXV	10
40	32	1"1/4	88	83	-	2038-03XXE	2038-03XXV	10
50	40	1"1/2	100	89	-	2038-04XXE	2038-04XXV	10
63	50	2"	108	95	-	2038-05XXE	2038-05XXV	10

OPTIONS série 2038



Pour motorisation et réhausse, opter pour un robinet type 1003.
Pour commander un robinet avec sphère PVDF, remplacer - par P dans la référence, par exemple 2038P02AAE.

For actuation or extended handle, use 1003 type valve.
To order a valve with a PVDF ball, replace - by P in the product code, for example 2038P02AAE.

ROBINET À TOURNANT SPHÉRIQUE

Ball valve

SERIE 2003



N° Fiche produit - Product sheet
TDS-BALL-1003

STANDARDS & APPROVALS

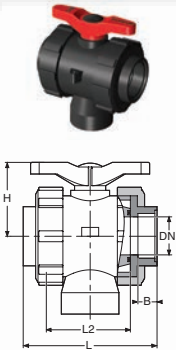

ROBINET PPGF À TOURNANT SPHÉRIQUE 3 VOIES, ENTRÉE TARAUDÉE PAS DU GAZ, DOUBLE UNION, EMBOUTS PPGF TARAUDÉS PAS DU GAZ CYLINDRIQUE

3-way PPGF ball valve, BSP threaded inlet, double union, BSP threaded PPGF sockets

DIMENSIONS Dimensions						RÉFÉRENCE Product code		
d	DN	G	L	H	B	EPDM	FPM	PN
mm	mm	inch	mm	mm	mm			bar
20	15	1/2"	134	75	17.5	2003-10AAAE	2003-10AAAV	10
25	20	3/4"	140	75	20.5	2003-11AAAE	2003-11AAAV	10
32	25	1"	136	78	23.5	2003-02AAAE	2003-02AAAV	10
40	32	1"1/4	152	83	27.5	2003-03AAAE	2003-03AAAV	10
50	40	1"1/2	164	89	24.5	2003-04AAAE	2003-04AAAV	10
63	50	2"	177	95	24.5	2003-05AAAE	2003-05AAAV	10

ROBINET PPGF À TOURNANT SPHÉRIQUE 3 VOIES, ENTRÉE TARAUDÉE PAS DU GAZ, DOUBLE UNION, EMBOUTS PP-H FEMELLES MÉTRIQUES

3-way PPGF ball valve, BSP threaded inlet, double union, PP-H metric sockets

DIMENSIONS Dimensions						RÉFÉRENCE Product code		
d	DN	G	L	H	B	EPDM	FPM	PN
mm	mm	inch	mm	mm	mm			bar
20	15	1/2"	130	75	17	2003-10ACCE	2003-10ACCV	10
25	20	3/4"	133	75	18	2003-11ACCE	2003-11ACCV	10
32	25	1"	129	78	20	2003-02ACCE	2003-02ACCV	10
40	32	1"1/4	142	83	22	2003-03ACCE	2003-03ACCV	10
50	40	1"1/2	161	89	25	2003-04ACCE	2003-04ACCV	10
63	50	2"	180	95	29.5	2003-05ACCE	2003-05ACCV	10

ROBINET PPGF À TOURNANT SPHÉRIQUE 3 VOIES, ENTRÉE TARAUDÉE PAS DU GAZ, DOUBLE UNION, AVEC ÉCROUS ET JOINTS, SANS EMBOUTS

3-way PPGF ball valve, BSP threaded inlet, double union, with union nuts and o-rings, without sockets

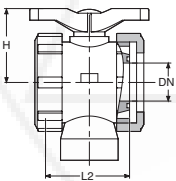

DIMENSIONS Dimensions						RÉFÉRENCE Product code		
d	DN	G	L2	H	B	EPDM	FPM	PN
mm	mm	inch	mm	mm	mm			bar
20	15	1/2"	88	75	-	2003-10AXXE	2003-10AXXV	10
25	20	3/4"	88	75	-	2003-11AXXE	2003-11AXXV	10
32	25	1"	80	78	-	2003-02AXXE	2003-02AXXV	10
40	32	1"1/4	88	83	-	2003-03AXXE	2003-03AXXV	10
50	40	1"1/2	100	89	-	2003-04AXXE	2003-04AXXV	10
63	50	2"	108	95	-	2003-05AXXE	2003-05AXXV	10

OPTIONS série 2003



Robinetts montés avec sphère en L. Sphère en double L ou T disponible sur demande (remplacer dans la référence le - par L ou T)
Par exemple robinet avec sphère en double L : 2003L05AAAE.

L Port as a standard. T Port or double L Port on request (replace in the product code - by L or T).

For example, ball with double L port : 2003L05AAAE.

ROBINET À TOURNANT SPHÉRIQUE

Ball valve

SERIE 2003



N° Fiche produit - Product sheet
TDS-BALL-1003

STANDARDS &
APPROVALS



SCHÉMA DE PRINCIPE DU ROBINET 3 VOIES

Handle set up for 3 way valve

Handle Set Up:

0°

90°

180°

(1) L Port:

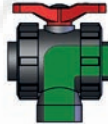

(2) T Port:



Fluid inlet



quotes@tfpes.co.uk

PPGF

ROBINET À TOURNANT SPHÉRIQUE

Ball valve

SERIE 1003



N° Fiche produit - Product sheet
TDS-BALL-1003D



ROBINET PPGF DN50 À TOURNANT SPHÉRIQUE 3 VOIES HORIZONTALES, À UNIONS, EMBOUTS PPGF TARAUDÉS PAS DU GAZ CYLINDRIQUE

Horizontal 3-way union DN50 PPGF ball valve, BSP threaded PPGF sockets

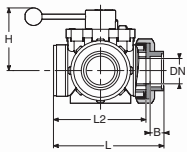

DIMENSIONS Dimensions						RÉFÉRENCE Product code			NOTE
d	DN	G	L	H	B	EPDM	FPM	PN bar	
63	50	2"	217	140	24.5	1003-29AAAE	1003-29AAAV	10	Sphère en L / L port
63	50	2"	217	140	24.5	1003-30AAAE	1003-30AAAV	10	Sphère en T / T port

ROBINET PPGF DN50 À TOURNANT SPHÉRIQUE 3 VOIES HORIZONTALES, À UNIONS, AVEC ÉCROUS ET JOINTS, SANS EMBOUTS

Horizontal 3-way union DN50 PPGF ball valve, with union nuts and o-rings, without sockets

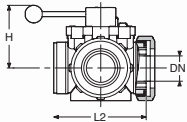

DIMENSIONS Dimensions						RÉFÉRENCE Product code			NOTE
d	DN	G	L2	H	B	EPDM	FPM	PN bar	
63	50	2"	175	140	-	1003-29XXXE	1003-29XXXV	10	Sphère en L / L port
63	50	2"	175	140	-	1003-30XXXE	1003-30XXXV	10	Sphère en T / T port

Handle Set Up:

0°

90°

180°

270°

(1) L Port:



(2) T Port:

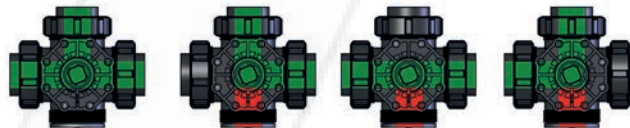

OPTIONS série 1003



ROBINET À TOURNANT SPHÉRIQUE

Ball valve

SERIE 1003



N° Fiche produit - Product sheet
TDS-BALL-1003D



ROBINET PPGF DN50 À TOURNANT SPHÉRIQUE 4 VOIES HORIZONTALES, À UNIONS, EMBOUTS PPGF TARAUDÉS PAS DU GAZ CYLINDRIQUE

Horizontal 4-way union DN50 PPGF ball valve, BSP threaded PPGF sockets

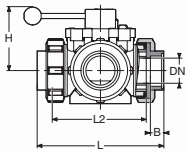

DIMENSIONS Dimensions						RÉFÉRENCE Product code			NOTE
d	DN	G	L	H	B	EPDM	FPM	PN bar	
63	50	2"	244	140	24.5	1003-31AAAAE	1003-31AAAAV	10	Sphère en L / L port
63	50	2"	244	140	24.5	1003-32AAAAE	1003-32AAAAV	10	Sphère en T / T port

ROBINET PPGF DN50 À TOURNANT SPHÉRIQUE 4 VOIES HORIZONTALES, À UNIONS, AVEC ÉCROUS ET JOINTS, SANS EMBOUTS

Horizontal 4-way union DN50 PPGF ball valve, with union nuts and o-rings, without sockets

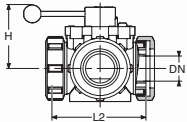

DIMENSIONS Dimensions						RÉFÉRENCE Product code			NOTE
d	DN	G	L2	H	B	EPDM	FPM	PN bar	
63	50	2"	175	140	-	1003-31XXXXXE	1003-31XXXXXV	10	Sphère en L / L port
63	50	2"	175	140	-	1003-32XXXXXE	1003-32XXXXXV	10	Sphère en T / T port

Handle Set Up:

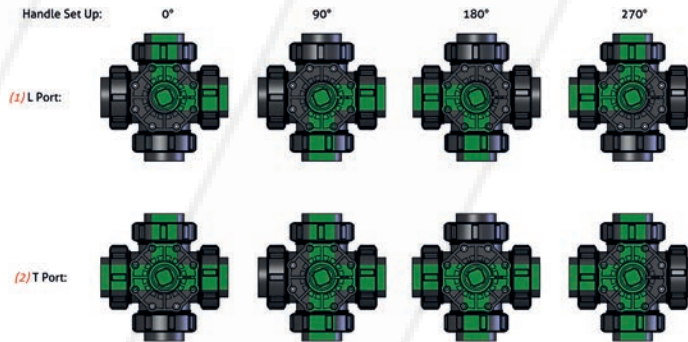

OPTIONS série 1003



quotes@tipes.co.uk

PPGF

ROBINET À TOURNANT SPHÉRIQUE

Ball valve

SERIE 1003



N° Fiche produit - Product sheet
TDS-BALL-1003D



ROBINET PPGF DN50 À TOURNANT SPHÉRIQUE 5 VOIES, À UNIONS, EMBOUTS PPGF TARAUDÉS PAS DU GAZ CYLINDRIQUE

5-way union DN50 PPGF ball valve, BSP threaded PPGF sockets

DIMENSIONS Dimensions						RÉFÉRENCE Product code		
d	DN	G	L	H	B	EPDM	FPM	PN
mm	mm	inch	mm	mm	mm			bar
63	50	2"	244	140	24.5	1003-38AAAAAE	1003-38AAAAAV	10

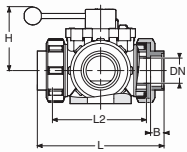

ROBINET PPGF DN50 À TOURNANT SPHÉRIQUE 5 VOIES, À UNIONS, AVEC ÉCROUS ET JOINTS, SANS EMBOUTS

5-way union DN50 PPGF ball valve, with union nuts and o-rings, without sockets

DIMENSIONS Dimensions						RÉFÉRENCE Product code		
d	DN	G	L2	H	B	EPDM	FPM	PN
mm	mm	inch	mm	mm	mm			bar
63	50	2"	175	140	-	1003-38AXXXXE	1003-38AXXXV	10

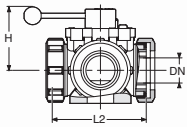

L'ENTRÉE SE FAIT PAR LA VOIE DU BAS DU ROBINET (TARAUDÉE)

Inlet is underneath the valve (BSP female threaded)



Handle Set Up:

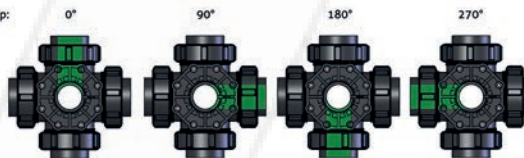

OPTIONS série 1003



ROBINET À TOURNANT SPHÉRIQUE

Ball valve

SERIE 2008



N° Fiche produit - Product sheet
TDS-BALL-2008A

STANDARDS &
APPROVALS

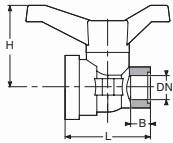

ROBINET PPGF À TOURNANT SPHÉRIQUE 2 VOIES, COMPACT, SORTIES TARAUDÉES PAS DU GAZ CYLINDRIQUE
2-way PPGF ball valve, compact, BSP threaded sockets

DIMENSIONS Dimensions						RÉFÉRENCE Product code		
d	DN	G	L	H	B	EPDM	FPM	PN
mm	mm	inch	mm	mm	mm			bar
20	15	1/2"	78	75	15	2008-00AAE	2008-00AAV	10
25	20	3/4"	78	75	16	2008-01AAE	2008-01AAV	10

OPTIONS série 2008



quotes@tfpes.co.uk

PPGF

ROBINET À TOURNANT SPHÉRIQUE

Ball valve

SERIE 1003



N° Fiche produit - Product sheet
TDS-BALL-1003C

STANDARDS & APPROVALS

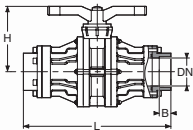

ROBINET PPGF À TOURNANT SPHÉRIQUE 2 VOIES, SANDWICH, SORTIES TARAUDÉES PAS DU GAZ CYLINDRIQUE

2-way PPGF ball valve, sandwich construction, BSP threaded sockets

DIMENSIONS Dimensions						RÉFÉRENCE Product code		
d	DN	G	L	H	B	EPDM	FPM	PN
mm	mm	inch	mm	mm	mm			bar
90	80	3"	430	180	39.5	1003-33AAE	1003-33AAV	10

ROBINET PPGF À TOURNANT SPHÉRIQUE 2 VOIES, SANDWICH, EMBOUTS PP-H FEMELLES MÉTRIQUES

2-way PPGF ball valve, sandwich construction, PP-H metric sockets

DIMENSIONS Dimensions						RÉFÉRENCE Product code		
d	DN	G	L	H	B	EPDM	FPM	PN
mm	mm	inch	mm	mm	mm			bar
90	80	3"	430	180	50	1003-33CCE	1003-33CCV	10

ROBINET PPGF À TOURNANT SPHÉRIQUE 2 VOIES, SANDWICH, EMBOUTS PE100 FEMELLES

2-way PPGF ball valve, sandwich construction, PE100 sockets

DIMENSIONS Dimensions						RÉFÉRENCE Product code		
d	DN	G	L	H	B	EPDM	FPM	PN
mm	mm	inch	mm	mm	mm			bar
90	80	3"	428	180	51	1003-33UUE	1003-33UUV	10

ROBINET PPGF À TOURNANT SPHÉRIQUE 2 VOIES, SANDWICH, SORTIES MIXTES BRIDE DIN*, TARAUDÉE PAS DU GAZ CYLINDRIQUE

2-way PPGF ball valve, sandwich construction, mixed DIN* flange, BSP threaded socket

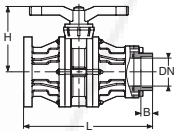

DIMENSIONS Dimensions						RÉFÉRENCE Product code		
d	DN	G	L	H	B	EPDM	FPM	PN
mm	mm	inch	mm	mm	mm			bar
90	80	3"	370	180	39.5	1003-33AFE	1003-33AFV	10

* DIN = EN1092-1 PN10/16

OPTIONS série 1003

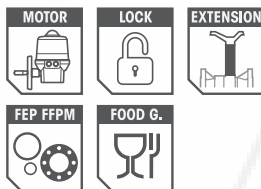

CLAPET
Check valve

SERIE 2001



N° Fiche produit - Product sheet
TDS-CHECK-2001

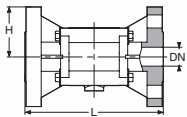

CLAPET PPGF À CÔNE ET RESSORT, SANDWICH À BRIDES
Flanged PPGF check valve with cone and spring, sandwich construction

DIMENSIONS Dimensions					RÉFÉRENCE (BRIDES DIN*) Product code (DIN flanges*)		RÉFÉRENCE (BRIDES ANSI*) Product code (ANSI flanges*)		PN bar
d mm	DN mm	G inch	L mm	H mm	EPDM	FPM	EPDM	FPM	
20	15	1/2"	130	47.5	2001-00FFEI	2001-00FFVI	2001-00GGEI	2001-00GGVI	10
25	20	3/4"	150	52.5	2001-01FFEI	2001-01FFVI	2001-01GGEI	2001-01GGVI	10

* DIN = EN1092-1 PN10/16

ANSI = ASME B16.5 Class 150



N° Fiche produit - Product sheet
TDS-CHECK-2001A

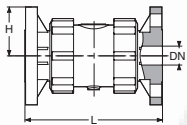

CLAPET PPGF À CÔNE ET RESSORT, DOUBLE UNION, À BRIDES DIN/ANSI **
PPGF check valve with cone and spring, double union, with DIN/ANSI flanges **

DIMENSIONS Dimensions					RÉFÉRENCE (BRIDES DIN/ANSI*) Product code (DIN/ANSI flanges*)		PN bar
d mm	DN mm	G inch	L mm	H mm	EPDM	FPM	
32	25	1"	160	57.5	2001-02FFEI	2001-02FFVI	10
40	32	1"1/4	180	70	2001-03FFEI	2001-03FFVI	10
50	40	1"1/2	200	75	2001-04FFEI	2001-04FFVI	10
63	50	2"	230	82.5	2001-05FFEI	2001-05FFVI	10
75	65	2"	290	92.5	2001-06FFEI	2001-06FFVI	10

* DIN = EN1092-1 PN10/16

ANSI = ASME B16.5 Class 150

** sauf DN65 : brides DIN

** except DN65: DIN flanges



N° Fiche produit - Product sheet
TDS-CHECK-2001B

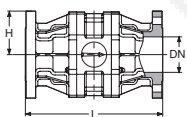

CLAPET PPGF À CÔNE ET RESSORT, SANDWICH À BRIDES
Flanged PPGF check valve with cone and spring, sandwich construction

DIMENSIONS Dimensions					RÉFÉRENCE (BRIDES DIN*) Product code (DIN flanges*)		RÉFÉRENCE (BRIDES ANSI*) Product code (ANSI flanges*)		PN bar
d mm	DN mm	G inch	L mm	H mm	EPDM	FPM	EPDM	FPM	
90	80	3"	310	100	2001-07FFEI	2001-07FFVI	2001-07GGEI	2001-07GGVI	10

* DIN = EN1092-1 PN10/16

ANSI = ASME B16.5 Class 150

OPTIONS série 2001



Ces clapets sont équipés d'un ressort en INOX 316. Pour un ressort en Hastelloy C, remplacer la lettre I par H dans la référence du produit.
Par exemple : 2001-00FFEH

These check valves are equipped with a spring in SS316. For a spring in Hastelloy C, replace the letter I by H in the product code.
For example : 2001-00FFEH

CLAPET
Check valve

SERIE 2001



N° Fiche produit - Product sheet
TDS-CHECK-2001

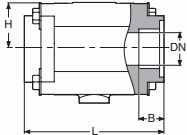

CLAPET PPGF À CÔNE ET RESSORT, SANDWICH, SORTIES TARAUDÉES PAS DU GAZ CYLINDRIQUE
PPGF check valve with cone and spring, 3 piece construction, BSP threaded sockets

DIMENSIONS Dimensions						RÉFÉRENCE Product code		
d	DN	G	L	H	B	EPDM	FPM	PN
mm	mm	inch	mm	mm	mm			bar
20	15	1/2"	85	27.5	16.8	2001-00AAEI	2001-00AAVI	10
25	20	3/4"	85	27.5	16.8	2001-01AAEI	2001-01AAVI	10

CLAPET PPGF À CÔNE ET RESSORT, SANDWICH, EMBOUTS PP-H FEMELLES
PPGF check valve with cone and spring, sandwich construction, PP-H sockets

DIMENSIONS Dimensions						RÉFÉRENCE Product code		
d	DN	G	L	H	B	EPDM	FPM	PN
mm	mm	inch	mm	mm	mm			bar
20	15	1/2"	125	27.5	16	2001-00CCEI	2001-00CCVI	10
25	20	3/4"	129	27.5	18	2001-01CCEI	2001-01CCVI	10

OPTIONS série 2001



Ces clapets sont équipés d'un ressort en INOX 316. Pour un ressort en Hastelloy C, remplacer la lettre I par H dans la référence du produit.
Par exemple : 2001-00AAEH

These check valves are equipped with a spring in SS316. For a spring in Hastelloy C, replace the letter I by H in the product code.
For example : 2001-00AAEH

CLAPET
Check valve

SERIE 2001



N° Fiche produit - Product sheet
TDS-CHECK-2001A

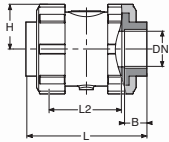

CLAPET PPGF À CÔNE ET RESSORT, DOUBLE UNION, EMBOUTS PPGF TARAUDÉS PAS DU GAZ CYLINDRIQUE
PPGF check valve with cone and spring, double union, BSP threaded PPGF sockets

DIMENSIONS Dimensions						RÉFÉRENCE Product code		
d	DN	G	L	H	B	EPDM	FPM	PN
mm	mm	inch	mm	mm	mm			bar
32	25	1"	136	42.5	23.5	2001-02AAEI	2001-02AAVI	10
40	32	1"1/4	152	48	27.5	2001-03AAEI	2001-03AAVI	10
50	40	1"1/2	164	56.5	24.5	2001-04AAEI	2001-04AAVI	10
63	50	2"	176	62.5	24.5	2001-05AAEI	2001-05AAVI	10

CLAPET PPGF À CÔNE ET RESSORT, DOUBLE UNION, EMBOUTS PP-H FEMELLES MÉTRIQUES
PPGF check valve with cone and spring, double union, PP-H metric sockets

DIMENSIONS Dimensions						RÉFÉRENCE Product code		
d	DN	G	L	H	B	EPDM	FPM	PN
mm	mm	inch	mm	mm	mm			bar
32	25	1"	129	42.5	20	2001-02CCEI	2001-02CCVI	10
40	32	1"1/4	142	48	22	2001-03CCEI	2001-03CCVI	10
50	40	1"1/2	161	56.5	25	2001-04CCEI	2001-04CCVI	10
63	50	2"	178	62.5	29.5	2001-05CCEI	2001-05CCVI	10

CLAPET PPGF À CÔNE ET RESSORT, DOUBLE UNION, AVEC ÉCROUS ET JOINTS, SANS EMBOUTS
PPGF check valve with cone and spring, double union, with unions nuts and o-rings, without sockets

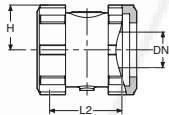

DIMENSIONS Dimensions						RÉFÉRENCE Product code		
d	DN	G	L2	H	B	EPDM	FPM	PN
mm	mm	inch	mm	mm	mm			bar
32	25	1"	80	42.5	-	2001-02XXEI	2001-02XXVI	10
40	32	1"1/4	88	48	-	2001-03XXEI	2001-03XXVI	10
50	40	1"1/2	100	56.5	-	2001-04XXEI	2001-04XXVI	10
63	50	2"	107	62.5	-	2001-05XXEI	2001-05XXVI	10

OPTIONS série 2001



Ces clapets sont équipés d'un ressort en INOX 316. Pour un ressort en Hastelloy C, remplacer la lettre I par H dans la référence du produit.
Par exemple : 2001-02AAEH

These check valves are equipped with a spring in SS316. For a spring in Hastelloy C, replace the letter I by H in the product code.
For example : 2001-02AAEH

quotes@tfpes.co.uk
PP-EL

PP-EL

Tel: 01626 201092

 276
www.safi-valves.com



PP-EL

ROBINETTERIE INDUSTRIELLE - Industrial valves

PP-EL

Ce polypropylène contient 20% de fibres de carbone.

Il a ainsi une résistivité superficielle fortement diminuée ($10^5 \Omega$) par rapport au PP standard (minimum $10^{17} \Omega$) lui permettant de mieux conduire l'électricité tout en préservant ses autres propriétés.

Il permet à toute une gamme de produits SAFI d'être compatible avec la réglementation ATEX zones 1 et 2.

This polypropylene contains 20% of carbon fibres.

Thus, its surface resistivity ($10^5 \Omega$) is significantly reduced compared to standard PP (minimum $10^{17} \Omega$), so it can better conduct electricity while keeping its other properties.

It enables a whole range of SAFI valves to comply with zones 1 and 2 ATEX regulation.

0°C → +90°C

TEMPÉRATURE DE SERVICE
Operating temperature

Tel: 01626 201092

www.safi-valves.com

ROBINET À TOURNANT SPHÉRIQUE

Ball valve

SERIE 2091



N° Fiche produit - Product sheet
TDS-BALL-2014

STANDARDS & APPROVALS



ROBINET PP-EL À TOURNANT SPHÉRIQUE 2 VOIES, COMPACT À BRIDES

2-way PP-EL ball valve, flanged compact

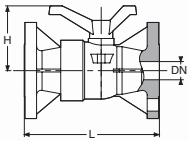

DIMENSIONS					RÉFÉRENCE (BRIDES DIN*)		RÉFÉRENCE (BRIDES ANSI*)		PN
Dimensions					Product code (DIN flanges*)		Product code (ANSI flanges*)		
d	DN	G	L	H	EPDM	FPM	EPDM	FPM	bar
20	15	1/2"	130	75	2091-00FFE	2091-00FFV	2091-00GGE	2091-00GGV	10
25	20	3/4"	150	75	2091-01FFE	2091-01FFV	2091-01GGE	2091-01GGV	10
32	25	1"	160	95	2091-02FFE	2091-02FFV	2091-02GGE	2091-02GGV	10
40	32	1"1/4	180	99	2091-03FFE	2091-03FFV	2091-03GGE	2091-03GGV	10
50	40	1"1/2	200	106	2091-04FFE	2091-04FFV	2091-04GGE	2091-04GGV	10
63	50	2"	230	111	2091-05FFE	2091-05FFV	2091-05GGE	2091-05GGV	10

* DIN = EN1092-1 PN10/16

ANSI = ASME B16.5 Class 150

OPTIONS série 2091

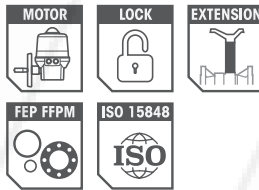

Pour commander un robinet avec plaquette de régulation, remplacer - par O dans la référence, par exemple 2091000FFE

To order a valve with a V plate, replace - by O in the product code, for example 2091000FFE



N° Fiche produit - Product sheet
TDS-BALL-1003B

STANDARDS & APPROVALS



ROBINET PP-EL À TOURNANT SPHÉRIQUE 2 VOIES, CADENASSABLE, SANDWICH À BRIDES

2-way flanged PP-EL ball valve, lockable, sandwich construction

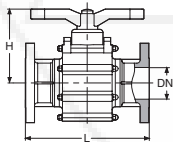

DIMENSIONS					RÉFÉRENCE (BRIDES DIN*)		RÉFÉRENCE (BRIDES ANSI*)		PN
Dimensions					Product code (DIN flanges*)		Product code (ANSI flanges*)		
d	DN	G	L	H	EPDM	FPM	EPDM	FPM	bar
90	80	3"	310	188	2091-27FFE	2091-27FFV	2091-27GGE	2091-27GGV	10
110	100	4"	350	188	2091-28FFE	2091-28FFV	2091-28GGE	2091-28GGV	10

* DIN = EN1092-1 PN10/16

ANSI = ASME B16.5 Class 150

OPTIONS série 2091

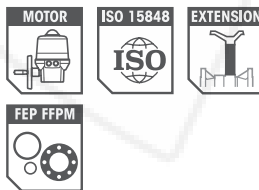

Pour commander un robinet avec plaquette de régulation, remplacer - par O dans la référence, par exemple 2091027FFE

To order a valve with a V plate, replace - by O in the product code, for example 2091027FFE

quotes@tfpes.co.uk

PP-EL

PVDF

Tel: 01626 201092



ROBINETTERIE INDUSTRIELLE - Industrial valves

PVDF

Le polyfluorure de vinylidène est très résistant mécaniquement et chimiquement. À l'instar des autres polymères fluorés, il supporte les variations de température (-20°C à +120°C), les ultraviolets et les agents chimiques les plus corrosifs. Le PVDF est un homopolymère sans additifs, non toxique. Il a une surface particulièrement lisse, qui évite le développement de micro-organismes.

SAFI a sélectionné un grade hautement cristallin de PVDF très résistant mécaniquement et très stable à long terme à haute température. Ce grade présente de plus une bonne résistance au chlore humide.

Les avantages principaux du PVDF sont les suivants :

1. Grande résistance chimique,
2. Plage de tenue thermique,
3. Résistance à l'abrasion,
4. Stabilité à haute température,
5. Facilité de soudure,
6. Résistant aux UV,
7. Bons états de surface.

PolyVinylidene fluoride has an excellent chemical and physical resistance. Such as other fluorinated polymers, it supports temperature variations from -20°C up to +120°C, ultra-violets and the most corrosive chemical agents. The PVDF is a homopolymer without additives, non-toxic, has a particularly smooth surface, which avoids the development of micro-organisms.

SAFI has selected a highly crystalline grade of PVDF, with a strong mechanical resistance and an excellent long term stability at high temperature. This grade has particularly good resistance in wet chlorine applications.

The main advantages of PVDF are:

1. High chemical resistance,
2. Temperature range (-20°C up to 120°C),
3. Abrasion resistance,
4. High temperature stability,
5. Welded easily,
6. UV resistance,
7. Smooth finish surface.

-20°C → +120°C

TEMPÉRATURE DE SERVICE
Operating temperature

ROBINET À TOURNANT SPHÉRIQUE

Ball valve

SERIE 2029



N° Fiche produit - Product sheet
TDS-BALL-2014

STANDARDS & APPROVALS



ROBINET PVDF À TOURNANT SPHÉRIQUE 2 VOIES, COMPACT À BRIDES

2-way PVDF ball valve, flanged compact

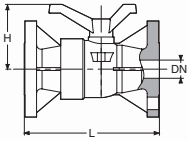

DIMENSIONS					RÉFÉRENCE (BRIDES DIN*)		RÉFÉRENCE (BRIDES ANSI*)		PN bar
Dimensions					Product code (DIN flanges*)		Product code (ANSI flanges*)		
d	DN	G	L	H	EPDM	FPM	EPDM	FPM	
mm	mm	inch	mm	mm					
20	15	1/2"	130	75	2029-00FFE	2029-00FFZ	2029-00GGE	2029-00GGZ	16
25	20	3/4"	150	75	2029-01FFE	2029-01FFZ	2029-01GGE	2029-01GGZ	16
32	25	1"	160	95	2029-02FFE	2029-02FFZ	2029-02GGE	2029-02GGZ	16
40	32	1"1/4	180	99	2029-03FFE	2029-03FFZ	2029-03GGE	2029-03GGZ	16
50	40	1"1/2	200	106	2029-04FFE	2029-04FFZ	2029-04GGE	2029-04GGZ	16
63	50	2"	230	111	2029-05FFE	2029-05FFZ	2029-05GGE	2029-05GGZ	16

* DIN = EN1092-1 PN10/16

ANSI = ASME B16.5 Class 150

OPTIONS série 2029

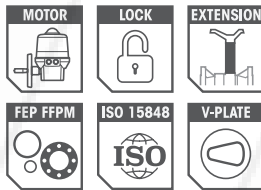

Pour commander un robinet avec plaquette de régulation, remplacer - par O dans la référence, par exemple 2029000FFE.

To order a valve with a V plate, replace - by O in the product code, for example 2029000FFE.

SERIE 2027



N° Fiche produit - Product sheet
TDS-BALL-1003B

STANDARDS & APPROVALS



ROBINET PVDF À TOURNANT SPHÉRIQUE 2 VOIES, CADENASSABLE, SANDWICH À BRIDES

2-way flanged PVDF ball valve, lockable, sandwich construction

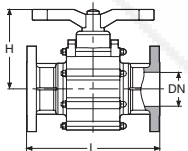

DIMENSIONS					RÉFÉRENCE (BRIDES DIN*)		RÉFÉRENCE (BRIDES ANSI*)		PN bar
Dimensions					Product code (DIN flanges*)		Product code (ANSI flanges*)		
d	DN	G	L	H	EPDM	FPM	EPDM	FPM	
mm	mm	inch	mm	mm					
90	80	3"	310	188	2027-17FFE	2027-17FFZ	2027-17GGE	2027-17GGZ	10
110	100	4"	350	188	2027-18FFE	2027-18FFZ	2027-18GGE	2027-18GGZ	10

* DIN = EN1092-1 PN10/16

ANSI = ASME B16.5 Class 150

OPTIONS série 2027

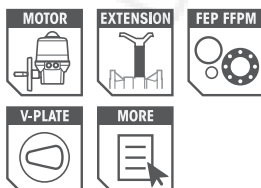

Pour commander un robinet avec plaquette de régulation, remplacer - par O dans la référence, par exemple 2027017FFE.

To order a valve with a V plate, replace - by O in the product code, for example 2027017FFE.

quotes@tipres.co.uk

ROBINET À TOURNANT SPHÉRIQUE

Ball valve

SERIE 2029



N° Fiche produit - Product sheet
TDS-BALL-2008

STANDARDS &
APPROVALS

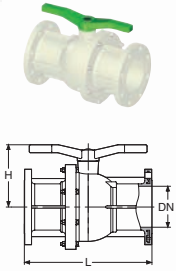

ROBINET PVDF À TOURNANT SPHÉRIQUE 2 VOIES, CADENASSABLE, COMPACT À BRIDES DIN/ANSI*
2-way PVDF ball valve, lockable, flanged compact, with DIN/ANSI* flanges

DIMENSIONS					RÉFÉRENCE (BRIDES DIN/ANSI*)		
Dimensions					Product code (DIN/ANSI flanges*)		
d	DN	G	L	H	EPDM	FPM	PN
mm	mm	inch	mm	mm			bar
160	150	6"	480	235	2029-10FFE	2029-10FFZ	10

* DIN = EN1092-1 PN10/16

ANSI = ASME B16.5 Class 150

OPTIONS série 2029

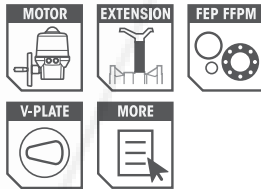

Pour commander un robinet avec plaquette de régulation, remplacer - par O dans la référence, par exemple 2029O10FFE.

To order a valve with a V plate, replace - by O in the product code, for example 2029O10FFE.

quotes@tipes.co.uk

PVDF

ROBINET À TOURNANT SPHÉRIQUE

Ball valve

SERIE 2027



N° Fiche produit - Product sheet
TDS-BALL-1003

STANDARDS &
APPROVALS

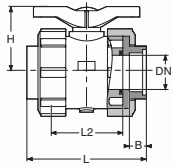

ROBINET PVDF À TOURNANT SPHÉRIQUE 2 VOIES, DOUBLE UNION, EMBOUTS PVDF TARAUDÉS PAS DU GAZ CYLINDRIQUE

2-way PVDF ball valve, double union, BSP threaded PVDF sockets

DIMENSIONS Dimensions						RÉFÉRENCE Product code	
d	DN	G	L	H	B	FPM	PN
mm	mm	inch	mm	mm	mm		bar
20	15	1/2"	134	75	18	2027-10AAZ	10
25	20	3/4"	140	75	21	2027-11AAZ	10
32	25	1"	137	78	22	2027-02AAZ	10
40	32	1"1/4	147	83	24	2027-03AAZ	10
50	40	1"1/2	161	89	24	2027-04AAZ	10
63	50	2"	171	95	24	2027-05AAZ	10

ROBINET PVDF À TOURNANT SPHÉRIQUE 2 VOIES, DOUBLE UNION, EMBOUTS PVDF FEMELLES MÉTRIQUES

2-way PVDF ball valve, double union, PVDF metric sockets

DIMENSIONS Dimensions						RÉFÉRENCE Product code	
d	DN	G	L	H	B	FPM	PN
mm	mm	inch	mm	mm	mm		bar
20	15	1/2"	131	75	17	2027-10CCZ	10
25	20	3/4"	134	75	20	2027-11CCZ	10
32	25	1"	129	78	20	2027-02CCZ	10
40	32	1"1/4	139	83	22	2027-03CCZ	10
50	40	1"1/2	161	89	25	2027-04CCZ	10
63	50	2"	178	95	29.5	2027-05CCZ	10

ROBINET PVDF À TOURNANT SPHÉRIQUE 2 VOIES, DOUBLE UNION, AVEC ÉCROUS ET JOINTS, SANS EMBOUTS

2-way PVDF ball valve, double union, with union nuts and o-rings, without sockets

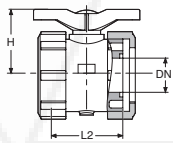

DIMENSIONS Dimensions						RÉFÉRENCE Product code	
d	DN	G	L2	H	B	FPM	PN
mm	mm	inch	mm	mm	mm		bar
20	15	1/2"	88	75	-	2027-10XXZ	10
25	20	3/4"	88	75	-	2027-11XXZ	10
32	25	1"	79	78	-	2027-02XXZ	10
40	32	1"1/4	86.5	83	-	2027-03XXZ	10
50	40	1"1/2	98	89	-	2027-04XXZ	10
63	50	2"	105	95	-	2027-05XXZ	10

OPTIONS série 2027

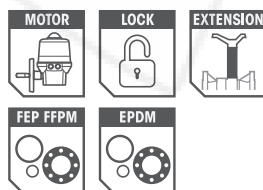

quotes@fipes.co.uk

ROBINET À TOURNANT SPHÉRIQUE

Ball valve

SERIE 2035



N° Fiche produit - Product sheet
TDS-BALL-1003

STANDARDS &
APPROVALS



ROBINET PVDF À TOURNANT SPHÉRIQUE 3 VOIES, ENTRÉE TARAUDÉE PAS DU GAZ CYLINDRIQUE, DOUBLE UNION, EMBOUTS PVDF TARAUDÉS PAS DU GAZ CYLINDRIQUE

3-way PVDF ball valve, BSP threaded inlet, double union, BSP threaded PVDF sockets

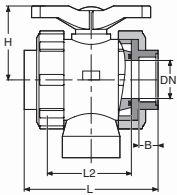

DIMENSIONS Dimensions						RÉFÉRENCE Product code	
d	DN	G	L	H	B	FPM	PN
mm	mm	inch	mm	mm	mm		bar
20	15	1/2"	134	75	18	2035-10AAAZ	10
25	20	3/4"	140	75	21	2035-11AAAZ	10
32	25	1"	137	78	22	2035-02AAAZ	10
40	32	1"1/4	147	83	24	2035-03AAAZ	10
50	40	1"1/2	161	89	24	2035-04AAAZ	10
63	50	2"	171	95	24	2035-05AAAZ	10

ROBINET PVDF À TOURNANT SPHÉRIQUE 3 VOIES, ENTRÉE TARAUDÉE PAS DU GAZ CYLINDRIQUE, DOUBLE UNION, EMBOUTS PVDF FEMELLES MÉTRIQUES

3-way PVDF ball valve, BSP threaded inlet, double union, PVDF metric sockets

DIMENSIONS Dimensions						RÉFÉRENCE Product code	
d	DN	G	L	H	B	FPM	PN
mm	mm	inch	mm	mm	mm		bar
20	15	1/2"	131	75	17	2035-10ACCZ	10
25	20	3/4"	134	75	20	2035-11ACCZ	10
32	25	1"	129	78	20	2035-02ACCZ	10
40	32	1"1/4	139	83	22	2035-03ACCZ	10
50	40	1"1/2	161	89	25	2035-04ACCZ	10
63	50	2"	178	95	29.5	2035-05ACCZ	10

ROBINET PVDF À TOURNANT SPHÉRIQUE 3 VOIES, ENTRÉE TARAUDÉE PAS DU GAZ CYLINDRIQUE, DOUBLE UNION, AVEC ÉCROUS ET JOINTS, SANS EMBOUTS

3-way PVDF ball valve, BSP threaded inlet, double union, with union nuts and o-rings, without sockets

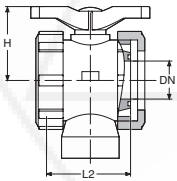

DIMENSIONS Dimensions					RÉFÉRENCE Product code	
d	DN	G	L2	H	FPM	PN
mm	mm	inch	mm	mm		bar
20	15	1/2"	88	75	2035-10AXXZ	10
25	20	3/4"	88	75	2035-11AXXZ	10
32	25	1"	79	78	2035-02AXXZ	10
40	32	1"1/4	86.5	83	2035-03AXXZ	10
50	40	1"1/2	98	89	2035-04AXXZ	10
63	50	2"	105	95	2035-05AXXZ	10

OPTIONS série 2035



Robinetts montés avec sphère en L. Sphère en double L ou T disponible sur demande (remplacer dans la référence le - par L ou T).
Par exemple robinet avec sphère en double L : 2003L05AAAE.

L Port as a standard. T Port or double L Port on request (replace in the product code - by L or T).
For example, ball with double L port : 2003L05AAAE.

ROBINET À TOURNANT SPHÉRIQUE

Ball valve

SERIE 2035



N° Fiche produit - Product sheet
TDS-BALL-1003

STANDARDS &
APPROVALS



SCHÉMA DE PRINCIPE DU ROBINET 3 VOIES

Handle set up for 3 way valve

Handle Set Up:

0°

90°

180°

(1) L Port:

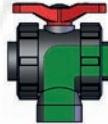

(2) T Port:



Fluid inlet



ROBINET À MEMBRANE

Diaphragm valve

SERIE 2200



N° Fiche produit - Product sheet
TDS-DIAPH-2300

STANDARDS &
APPROVALS



ROBINET PVDF À MEMBRANE À BRIDES

Flanged PVDF diaphragm valve

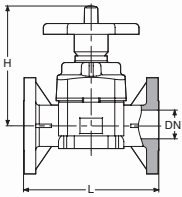

DIMENSIONS					RÉFÉRENCE (BRIDES DIN*)			RÉFÉRENCE (BRIDES ANSI*)			PN
Dimensions					Product code (DIN flanges*)			Product code (ANSI flanges*)			
d	DN	G	L	H	EPDM	FPM	PTFE	EPDM	FPM	PTFE	bar
20	15	1/2"	130	133	2200-00FFE	2200-00FFZ	2200-00FFP	2200-00GGE	2200-00GGZ	2200-00GGP	10
25	20	3/4"	150	133	2200-01FFE	2200-01FFZ	2200-01FFP	2200-01GGE	2200-01GGZ	2200-01GGP	10
32	25	1"	160	133	2200-02FFE	2200-02FFZ	2200-02FFP	2200-02GGE	2200-02GGZ	2200-02GGP	10
40	32	1"1/4	180	167	2200-03FFE	2200-03FFZ	2200-03FFP	2200-03GGE	2200-03GGZ	2200-03GGP	10
50	40	1"1/2	200	167	2200-04FFE	2200-04FFZ	2200-04FFP	2200-04GGE	2200-04GGZ	2200-04GGP	10
63	50	2"	230	205	2200-05FFE	2200-05FFZ	2200-05FFP	2200-05GGE	2200-05GGZ	2200-05GGP	10

* DIN = EN1092-1 PN10/16

ANSI = ASME B16.5 Class 150



ROBINET PVDF À MEMBRANE, DOUBLE UNION, EMBOUTS PVDF FEMELLES MÉTRIQUES

PVDF diaphragm valve, double union, PVDF metric sockets

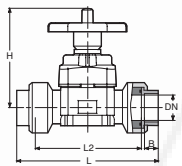

DIMENSIONS							RÉFÉRENCE			PN
Dimensions							Product code			
d	DN	G	L	L2	H	B	EPDM	FPM	PTFE	bar
20	15	1/2"	177	134	133	17	2200-00CCE	2200-00CCZ	2200-00CCP	10
25	20	3/4"	176	134	133	18	2200-01CCE	2200-01CCZ	2200-01CCP	10
32	25	1"	182	133	133	20	2200-02CCE	2200-02CCZ	2200-02CCP	10
40	32	1"1/4	217	165	167	22	2200-03CCE	2200-03CCZ	2200-03CCP	10
50	40	1"1/2	240	178	167	25	2200-04CCE	2200-04CCZ	2200-04CCP	10
63	50	2"	269	197	205	29,5	2200-05CCE	2200-05CCZ	2200-05CCP	10



ROBINET PVDF À MEMBRANE, SORTIES PVDF MÂLES

PVDF diaphragm valve, PVDF metric spigot outlets

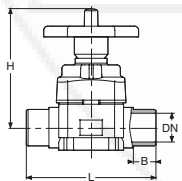

DIMENSIONS						RÉFÉRENCE			PN
Dimensions						Product code			
d	DN	G	L	H	B	EPDM	FPM	PTFE	bar
20	15	1/2"	124	133	17	2200-00ZZE	2200-00ZZZ	2200-00ZZP	10
25	20	3/4"	143	133	19.5	2200-01ZZE	2200-01ZZZ	2200-01ZZP	10
32	25	1"	154	133	23	2200-02ZZE	2200-02ZZZ	2200-02ZZP	10
40	32	1"1/4	174	167	28	2200-03ZZE	2200-03ZZZ	2200-03ZZP	10
50	40	1"1/2	194	167	33	2200-04ZZE	2200-04ZZZ	2200-04ZZP	10
63	50	2"	224	205	40	2200-05ZZE	2200-05ZZZ	2200-05ZZP	10

OPTIONS série 2200



- 2200 devient 2207 avec un actionneur pneumatique DE.
2200 becomes 2207 when fitted with a double acting pneumatic actuator.
- 2200 devient 2208 avec un actionneur pneumatique SE/NO.
2200 becomes 2208 when fitted with failsafe open (NO) pneumatic actuator.
- 2200 devient 2209 avec un actionneur pneumatique SE/NF.
2200 becomes 2209 when fitted with failsafe closed (NC) pneumatic actuator.

quotes@tipes.co.uk

PVDF

ROBINET À MEMBRANE

Diaphragm valve

SERIE 3203



N° Fiche produit - Product sheet
TDS-DIAPH-3200



ROBINET PVDF À MEMBRANE À BRIDES

Flanged PVDF diaphragm valve

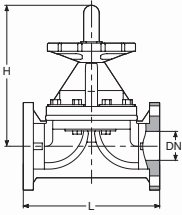

DIMENSIONS					RÉFÉRENCE (BRIDES DIN*)		RÉFÉRENCE (BRIDES ANSI*)			
Dimensions					Product code (DIN flanges*)		Product code (ANSI flanges*)		PN	PN
d	DN	G	L	H	EPDM	PTFE	EPDM	PTFE	bar	bar
mm	mm	inch	mm	mm					EPDM	PTFE
75	65	2"1/2	290	197	3203-06FFE	3203-06FFP	3203-06GGE	3203-06GGP	10	6
90	80	3"	310	293	3203-07FFE	3203-07FFP	3203-07GGE	3203-07GGP	10	5
110	100	4"	350	370	3203-08FFE	3203-08FFP	3203-08GGE	3203-08GGP	10	5
125	125	5"	400	412	3203-09FFE	3203-09FFP	3203-09GGE	3203-09GGP	5	4
160	150	6"	480	471	3203-10FFE	3203-10FFP	3203-10FFE	3203-10FFP	5	4
225	200	8"	600	625	3203-11FFE	3203-11FFP	3203-11GGE	3203-11GGP	3	2
280	250	10"	680	750	3203-12FFE	3203-12FFP	3203-12GGE	3203-12GGP	3	2

* DIN = EN1092-1 PN10/16

ANSI = ASME B16.5 Class 150

OPTIONS série 3203



quotes@tipes.co.uk

ROBINET A PAPILLON

Butterfly valve

SERIE 3700P



N° Fiche produit - Product sheet
TDS-BUTT-3600

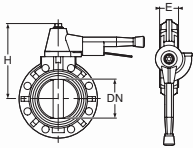

ROBINET À PAPILLON, CORPS PP-H, PAPILLON PVDF, MONTAGE WAFER ENTRE BRIDES, COMMANDE PAR POIGNÉE
Butterfly valve, PP-H body, PVDF butterfly, wafer type, with lever handle

DIMENSIONS Dimensions					RÉFÉRENCE (BRIDES DIN*) Product code (DIN flanges*)		RÉFÉRENCE (BRIDES ANSI*) Product code (ANSI flanges*)		PN bar
d mm	DN mm	G inch	H mm	E mm	EPDM	FPM	EPDM	FPM	
63	50	2"	168	43	3700P05WWE	3700P05WWV	3700AP05WWE	3700AP05WWV	10
75	65	2"1/2	176	45	3700P06WWE	3700P06WWV	3700AP06WWE	3700AP06WWV	10
90	80	3"	183	45	3700P07WWE	3700P07WWV (1)	3700AP07WWE	3700AP07WWV (1)	10
110	100	4"	196	55	3700P08WWE	3700P08WWV (1)	3700AP08WWE	3700AP08WWV (1)	10
140	125	5"	250	65	3700P09WWE	3700P09WWV	3700AP09WWE	3700AP09WWV	10
160	150	6"	270	70	3700P10WWE	3700P10WWV (1)	3700P10WWE	3700P10WWV (1)	10
225	200	8"	307	87	3700LP11WWE	3700LP11WWV	3700ALP11WWE	3700ALP11WWV	10

* DIN = EN1092-1 PN10/16 ANSI = ASME B16.5 Class 150
(1) possibilité de manchette FPM haute performance (FPM grade F).
(1) possibility of gasket in high performance FPM (F grade).



N° Fiche produit - Product sheet
TDS-BUTT-3600A

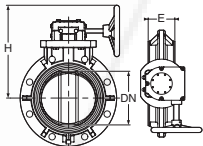

ROBINET À PAPILLON, CORPS PP-H, PAPILLON PVDF, MONTAGE WAFER ENTRE BRIDES, COMMANDE PAR RÉDUCTEUR MANUEL

Butterfly valve, PP-H body, PVDF butterfly, wafer type, with handwheel and reduction gearbox

DIMENSIONS Dimensions					RÉFÉRENCE (BRIDES DIN*) Product code (DIN flanges*)		RÉFÉRENCE (BRIDES ANSI*) Product code (ANSI flanges*)		PN bar
d mm	DN mm	G inch	H mm	E mm	EPDM	FPM	EPDM	FPM	
225	200	8"	322	87	3700P11WWE	3700P11WWV	3700AP11WWE	3700AP11WWV	10
280	250	10"	354	106	3700P12WWE	3700P12WWV	3700AP12WWE	3700AP12WWV	10
315	300	12"	495	128	3700P13WWE	3700P13WWV	3700AP13WWE	3700AP13WWV	7
355	350	14"	480	128	3700P14WWE	3700P14WWV	3700AP14WWE	3700AP14WWV	7
400	400	16"	606	169	3700P15WWE	3700P15WWV	3700AP15WWE	3700AP15WWV	6
450	450	18"	618	181	3700P16WWE	3700P16WWV	3700AP16WWE	3700AP16WWV	5
500	500	20"	690	191	3700P17WWE	3700P17WWV	3700AP17WWE	3700AP17WWV	3.5
630	600	24"	778	209	3700P18WWE	3700P18WWV	3700AP18WWE	3700AP18WWV	3.5
710	700	28"	879	206	3700P19WWE	3700P19WWV	3700AP19WWE	3700AP19WWV	1
800	800	32"	965	244	3700P20WWE	3700P20WWV	3700AP20WWE	3700AP20WWV	1
900	900	36"	1029	245	**	**	**	**	1
1000	1000	40"	1226	301	**	**	**	**	1

* DIN = EN1092-1 PN10 ANSI = ASME B16.5 Class 150
** Nous consulter.
** Consult us

OPTIONS série 3700P

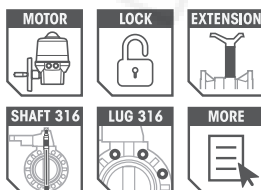

Pour commander un robinet papillon prêt pour motorisation, rajouter la référence ACTUREADY après celle du robinet. Par exemple 3700P05WWE + ACTUREADY
- pour les DN50 à 200 : la poignée crantée est enlevée, la face est dressée et percée
- pour les DN250 et supérieurs : le réducteur est enlevé
Les kits de motorisation pour robinets papillons se trouvent en page 170 du catalogue.

To order a butterfly valve ready for actuation, please add the code ACTUREADY after the code of the valve. For example 3700P05WWE + ACTUREADY
- for DN50 to 200 : the handled is removed, the face is machined and drilled
- for DN250 and higher : the gearbox is removed
The actuation kits for butterfly valves can be found on page 170 of the catalog.

quotes@tipes.co.uk

PVDF

ROBINET À PAPILLON

Butterfly valve

SERIE 3800



N° Fiche produit - Product sheet
TDS-BUTT-3600

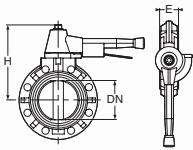

ROBINET À PAPILLON, CORPS PVDF, PAPILLON PVDF, MONTAGE WAFER ENTRE BRIDES, COMMANDE PAR POIGNÉE

Butterfly valve, PVDF body, PVDF butterfly, wafer type, with lever handle

DIMENSIONS Dimensions					RÉFÉRENCE (BRIDES DIN*) Product code (DIN flanges*)		RÉFÉRENCE (BRIDES ANSI*) Product code (ANSI flanges*)		PN bar
d mm	DN mm	G inch	H mm	E mm	EPDM	FPM	EPDM	FPM	
63	50	2"	167	43	3800-05WWE	3800-05WWV	3800A05WWE	3800A05WWV	10
75	65	2 1/2"	174	45	3800-06WWE	3800-06WWV	3800A06WWE	3800A06WWV	10
90	80	3"	183	45	3800-07WWE	3800-07WWV (1)	3800A07WWE	3800A07WWV (1)	10
110	100	4"	196	55	3800-08WWE	3800-08WWV (1)	3800A08WWE	3800A08WWV (1)	10
140	125	5"	260	65	3800-09WWE	3800-09WWV	3800A09WWE	3800A09WWV	10
160	150	6"	269	70	3800-10WWE	3800-10WWV (1)	3800-10WWE	3800-10WWV (1)	10
225	200	8"	295	87	3800L11WWE	3800L11WWV	3800AL11WWE	3800AL11WWV	10

* DIN = EN1092-1 PN1Q/16 ANSI = ASME B16.5 Class 150
(1) possibilité de manchette FPM haute performance (FPM grade F).
(1) possibility of gasket in high performance FPM (F grade).



N° Fiche produit - Product sheet
TDS-BUTT-3600A

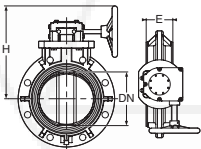

ROBINET À PAPILLON, CORPS PVDF, PAPILLON PVDF, MONTAGE WAFER ENTRE BRIDES, COMMANDE PAR RÉDUCTEUR MANUEL

Butterfly valve, PVDF body, PVDF butterfly, wafer type, with handwheel and reduction gearbox

DIMENSIONS Dimensions					RÉFÉRENCE (BRIDES DIN*) Product code (DIN flanges*)		RÉFÉRENCE (BRIDES ANSI*) Product code (ANSI flanges*)		PN bar
d mm	DN mm	G inch	H mm	E mm	EPDM	FPM	EPDM	FPM	
225	200	8"	322	87	3800-11WWE	3800-11WWV	3800A11WWE	3800A11WWV	10
280	250	10"	322	106	3800-12WWE	3800-12WWV	3800A12WWE	3800A12WWV	10
315	300	12"	463.5	128	3800-13WWE	3800-13WWV	3800A13WWE	3800A13WWV	7
355	350	14"	481.5	128	3800-14WWE	3800-14WWV	3800A14WWE	3800A14WWV	7
400	400	16"	606	169	3800-15WWE	3800-15WWV	3800A15WWE	3800A15WWV	6
450	450	18"	608	181	3800-16WWE	3800-16WWV	3800A16WWE	3800A16WWV	5
500	500	20"	648	191	3800-17WWE	3800-17WWV	3800A17WWE	3800A17WWV	3.5
630	600	24"	703	209	3800-18WWE	3800-18WWV	3800A18WWE	3800A18WWV	3.5

* DIN = EN1092-1 PN10 ANSI = ASME B16.5 Class 150

OPTIONS série 3800

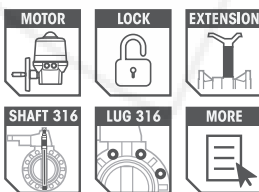

Pour commander un robinet papillon prêt pour motorisation, rajouter la référence ACTUREADY après celle du robinet. Par exemple 3800-05WWE + ACTUREADY
- pour les DN50 à 200 : la poignée crantée est enlevée, la face est dressée et percée
- pour les DN250 et supérieurs : le réducteur est enlevé
Les kits de motorisation pour robinets papillons se trouvent en page 170 du catalogue.

To order a butterfly valve ready for actuation, please add the code ACTUREADY after the code of the valve. For example 3800-05WWE + ACTUREADY
- for DN50 to 200 : the handled is removed, the face is machined and drilled
- for DN250 and higher : the gearbox is removed
The actuation kits for butterfly valves can be found on page 170 of the catalog.

CLAPET
Check valve

SERIE 2068



N° Fiche produit - Product sheet
TDS-CHECK-2001

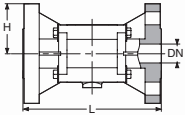

CLAPET PVDF À CÔNE ET RESSORT ⁽¹⁾, SANDWICH À BRIDES
Flanged PVDF check valve with cone and spring ⁽¹⁾, sandwich construction

DIMENSIONS					RÉFÉRENCE	RÉFÉRENCE	
Dimensions					(BRIDES DIN*)	(BRIDES ANSI*)	
d	DN	G	L	H	Product code	Product code	PN
mm	mm	inch	mm	mm	(DIN flanges*)	(ANSI flanges*)	bar
20	15	1/2"	130	46.5	FPM 2068-00FFZH	FPM 2068-00GGZH	10
25	20	3/4"	150	51.5	FPM 2068-01FFZH	FPM 2068-01GGZH	10

* DIN = EN1092-1 PN10/16 ANSI = ASME B16.5 Class 150

(1) Ressort en HASTELLOY C, disponible en INOX 316 sur demande.
(1) Spring in HASTELLOY C, also available in SS316 on request.



N° Fiche produit - Product sheet
TDS-CHECK-2001A

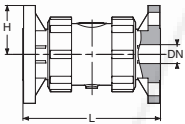

CLAPET PVDF À CÔNE ET RESSORT ⁽¹⁾, DOUBLE UNION, À BRIDES
PVDF check valve with cone and spring ⁽¹⁾, double union, with flanges

DIMENSIONS					RÉFÉRENCE	RÉFÉRENCE	
Dimensions					(BRIDES DIN*)	(BRIDES ANSI*)	
d	DN	G	L	H	Product code	Product code	PN
mm	mm	inch	mm	mm	(DIN flanges*)	(ANSI flanges*)	bar
32	25	1"	160	56	FPM 2068-02FFZH	FPM 2068-02GGZH	10
40	32	1"1/4	180	68.5	FPM 2068-03FFZH	FPM 2068-03GGZH	10
50	40	1"1/2	200	73.5	FPM 2068-04FFZH	FPM 2068-04GGZH	10
63	50	2"	230	80.5	FPM 2068-05FFZH	FPM 2068-05GGZH	10

* DIN = EN1092-1 PN10/16 ANSI = ASME B16.5 Class 150

(1) Ressort en HASTELLOY C, disponible en INOX 316 sur demande.
(1) Spring in HASTELLOY C, also available in SS316 on request.

DN65 et DN80 disponibles sur demande.
DN65 and DN80 available on request.

quotes@tipes.co.uk

PVDF

CLAPET
Check valve

SERIE 2068



N° Fiche produit - Product sheet
TDS-CHECK-2001

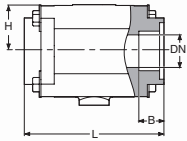

CLAPET PVDF À CÔNE ET RESSORT ⁽¹⁾, SANDWICH, SORTIES TARAUDÉES PAS DU GAZ CYLINDRIQUE
PVDF check valve with cone and spring ⁽¹⁾, sandwich construction, BSP threaded sockets

DIMENSIONS Dimensions						RÉFÉRENCE Product code	
d	DN	G	L	H	B	FPM	PN
mm	mm	inch	mm	mm	mm		bar
20	15	1/2"	82.5	27	15.5	2068-00AAZH	10
25	20	3/4"	82.5	27	15.5	2068-01AAZH	10

CLAPET PVDF À CÔNE ET RESSORT ⁽¹⁾, SANDWICH, EMBOUTS PVDF FEMELLES MÉTRIQUES
PVDF check valve with cone and spring ⁽¹⁾, sandwich construction, PVDF metric sockets

DIMENSIONS Dimensions						RÉFÉRENCE Product code	
d	DN	G	L	H	B	FPM	PN
mm	mm	inch	mm	mm	mm		bar
20	15	1/2"	121	27	16	2068-00CCZH	10
25	20	3/4"	126.5	27	18	2068-01CCZH	10

(1) Ressort en HASTELLOY C, disponible en INOX 316 sur demande.
(1) Spring in HASTELLOY C, also available in SS316 on request.



N° Fiche produit - Product sheet
TDS-CHECK-2001A

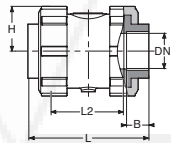

CLAPET PVDF À CÔNE ET RESSORT ⁽¹⁾, DOUBLE UNION, EMBOUTS PVDF TARAUDÉS PAS DU GAZ CYLINDRIQUE
PVDF check valve with cone and spring ⁽¹⁾, double union, BSP threaded PVDF sockets

DIMENSIONS Dimensions						RÉFÉRENCE Product code	
d	DN	G	L	H	B	FPM	PN
mm	mm	inch	mm	mm	mm		bar
32	25	1"	137	42.5	22	2068-02AAZH	10
40	32	1"1/4	146.5	48	24	2068-03AAZH	10
50	40	1"1/2	160	55.5	24	2068-04AAZH	10
63	50	2"	170	61.5	24	2068-05AAZH	10

CLAPET PVDF À CÔNE ET RESSORT ⁽¹⁾, DOUBLE UNION, EMBOUTS PVDF FEMELLES MÉTRIQUES
PVDF check valve with cone and spring ⁽¹⁾, double union, PVDF metric sockets

DIMENSIONS Dimensions						RÉFÉRENCE Product code	
d	DN	G	L	H	B	FPM	PN
mm	mm	inch	mm	mm	mm		bar
32	25	1"	128	42.5	20	2068-02CCZH	10
40	32	1"1/4	138.5	48	22	2068-03CCZH	10
50	40	1"1/2	160	55.5	25	2068-04CCZH	10
63	50	2"	177	61.5	29.5	2068-05CCZH	10

(1) Ressort en HASTELLOY C, disponible en INOX 316 sur demande.
(1) Spring in HASTELLOY C, also available in SS316 on request.

CLAPET

Check valve

SERIE 2068



N° Fiche produit - Product sheet
TDS-CHECK-2001A

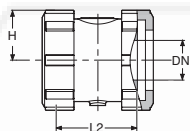

CLAPET PVDF À CÔNE ET RESSORT ⁽¹⁾, DOUBLE UNION, AVEC ÉCROUS ET JOINTS, SANS EMBOUTS
PVDF check valve with cone and spring ⁽¹⁾, double union, with unions nuts and o-rings, without sockets

DIMENSIONS Dimensions					RÉFÉRENCE Product code	
d	DN	G	L2	H	FPM	PN
mm	mm	inch	mm	mm		bar
32	25	1"	79	42.5	2068-02XXZH	10
40	32	1"1/4	86.5	48	2068-03XXZH	10
50	40	1"1/2	98	56.5	2068-04XXZH	10
63	50	2"	105	62.5	2068-05XXZH	10

(1) Ressort en HASTELLOY C, disponible en INOX 316 sur demande.
(1) Spring in HASTELLOY C, also available in SS316 on request.

CLAPET
Check valve

SERIE 2044



N° Fiche produit - Product sheet
TDS-CHECK-2054

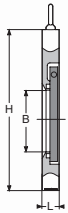

CLAPET PVDF À BATTANT, MONTAGE WAFER ENTRE BRIDES
Wafer PVDF swing check valve

DIMENSIONS Dimensions							RÉFÉRENCE (BRIDES DIN*) Product code (DIN flanges*)		RÉFÉRENCE (BRIDES ANSI*) Product code (ANSI flanges*)		PN bar
d	DN	G	L	H	H	B	FPM	FFPM	FPM	FFPM	
mm	mm	inch	mm	mm	mm	mm					
63	50	2"	23	109	101	28	2044D05RPZ	2044D05RPD	2044A05RPZ	2044A05RPD	16
75	65	2 1/2"	23	130	120	40	2044D06RPZ	2044D06RPD	2044A06RPZ	2044A06RPD	16
90	80	3"	23	144	132	48	2044D07RPZ	2044D07RPD	2044A07RPZ	2044A07RPD	16
110	100	4"	23	164	170	70	2044D08RPZ	2044D08RPD	2044A08RPZ	2044A08RPD	10
140	125	5"	25	194	193	90	2044D09RPZ	2044D09RPD	2044A09RPZ	2044A09RPD	10
160	150	6"	30	220	220	109	2044D10RPZ	2044D10RPD	2044D10RPZ	2044D10RPD	10
225	200	8"	35	275	275	140	2044D11RTZ	2044D11RTD	2044D11RTZ	2044D11RTD	8
280	250	10"	35	330	336	176	2044D12RTZ	2044D12RTD	2044A12RTZ	2044A12RTD	8
315	300	12"	40	380	406	208	2044D13RTZ	2044D13RTD	2044A13RTZ	2044A13RTD	6
355	350	14"	50	422	447	268	2044D14RTZ	2044D14RTD	2044A14RTZ	2044A14RTD	5
400	400	16"	50	470	511	287	2044D15RTZ	2044D15RTD	2044A15RTZ	2044A15RTD	5
450	450	18"	60	538	544	339	2044D16RTZ	2044D16RTD	2044A16RTZ	2044A16RTD	4

* DIN = EN1092-1 PN10

ANSI = ASME B16.5 Class 150

Axe en PVDF jusqu'au DN150 inclus, puis axe en titane.
Joint EPDM possible sur demande.
PVDF flap pin from DN50 to DN150. Titanium flap pin for DN>150.
EPDM seal available on demand.

SERIE 3306



N° Fiche produit - Product sheet
TDS-CHECK-3300

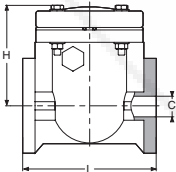

CLAPET PVDF À BATTANT À BRIDES
Flanged PVDF swing check valve

DIMENSIONS Dimensions						RÉFÉRENCE (BRIDES DIN*) Product code (DIN flanges*)	RÉFÉRENCE (BRIDES ANSI*) Product code (ANSI flanges*)	PN** bar
d	DN	G	L	H	C	FPM	FPM	
mm	mm	inch	mm	mm	mm			
20	15	1/2"	160	129	25	3306-00FFV	3306-00GGV	6
25	20	3/4"	160	129	25	3306-01FFV	3306-01GGV	6
32	25	1"	160	129	25	3306-02FFV	3306-02GGV	6
40	32	1 1/4"	180	141	41	3306-03FFV	3306-03GGV	6
50	40	1 1/2"	180	141	40	3306-04FFV	3306-04GGV	6
63	50	2"	200	165	50	3306-05FFV	3306-05GGV	6
75	65	2 1/2"	260	180	80	3306-06FFV	3306-06GGV	6
90	80	3"	260	180	80	3306-07FFV	3306-07GGV	6
110	100	4"	300	216	100	3306-08FFV	3306-08GGV	5
140	125	5"	350	239.5	125	3306-09FFV	3306-09GGV	5
160	150	6"	400	273	150	3306-10FFV	3306-10FFV	4
225	200	8"	500	310	200	3306-11FFV	3306-11GGV	3

* DIN = EN1092-1 PN10/16

ANSI = ASME B16.5 Class 150

** PN 10 : nous consulter

** PN 10: consult us

FILTRE
Strainer

SERIE 4670



N° Fiche produit - Product sheet
TDS-INCL-4640

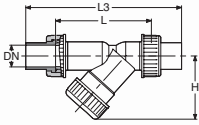

FILTRE EN Y EN PVDF, MAILLE EN ETFE DE 0.5 MM, DOUBLE UNION, EMBOUTS PVDF MÂLES
Y strainer in PVDF, mesh size 0.5 mm (ETFE), double union, PVDF metric spigots

DIMENSIONS Dimensions						RÉFÉRENCE Product code		
d	DN	G	L	L3	H	EPDM	FPM	PN
mm	mm	inch	mm	mm	mm			bar
20	15	1/2"	130	238	75	4670-00IIE05T	4670-00IIV05T	16
25	20	3/4"	150	264	80	4670-01IIE05T	4670-01IIV05T	16
32	25	1"	160	280	90	4670-02IIE05T	4670-02IIV05T	16
40	32	1 1/4"	180	306	110	4670-03IIE05T	4670-03IIV05T	16
50	40	1 1/2"	200	332	128	4670-04IIE05T	4670-04IIV05T	16
63	50	2"	230	368	150	4670-05IIE05T	4670-05IIV05T	16

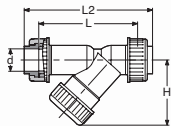

FILTRE EN Y EN PVDF, MAILLE EN ETFE DE 0.5 MM, DOUBLE UNION, EMBOUTS PVDF FEMELLES MÉTRIQUES
Y strainer in PVDF, mesh size 0.5 mm (ETFE), double union, PVDF metric sockets

DIMENSIONS Dimensions						RÉFÉRENCE Product code		
d	DN	G	L	L2	H	EPDM	FPM	PN
mm	mm	inch	mm	mm	mm			bar
20	15	1/2"	130	168	75	4670-00CCE05T	4670-00CCV05T	16
25	20	3/4"	150	192	80	4670-01CCE05T	4670-01CCV05T	16
32	25	1"	160	206	90	4670-02CCE05T	4670-02CCV05T	16
40	32	1 1/4"	180	230	110	4670-03CCE05T	4670-03CCV05T	16
50	40	1 1/2"	200	256	128	4670-04CCE05T	4670-04CCV05T	16
63	50	2"	230	294	150	4670-05CCE05T	4670-05CCV05T	16

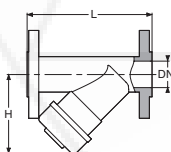

FILTRE EN Y EN PVDF, MAILLE EN ETFE DE 0.5 MM, À BRIDES DIN*
Y strainer in PVDF, mesh size 0.5 mm (ETFE), with DIN* flanges

DIMENSIONS Dimensions					RÉFÉRENCE Product code		
d	DN	G	L	H	EPDM	FPM	PN
mm	mm	inch	mm	mm			bar
20	15	1/2"	130	75	4670-00FFE05T	4670-00FFV05T	16
25	20	3/4"	150	80	4670-01FFE05T	4670-01FFV05T	16
32	25	1"	160	90	4670-02FFE05T	4670-02FFV05T	16
40	32	1 1/4"	180	110	4670-03FFE05T	4670-03FFV05T	16
50	40	1 1/2"	200	128	4670-04FFE05T	4670-04FFV05T	16
63	50	2"	230	150	4670-05FFE05T	4670-05FFV05T	16

* DIN = EN1092-1 PN10/16

- Autre taille de maille, nous consulter.
- Perçage de bride ANSI/ASME B16.5 Class 150, nous consulter.
- Please contact us for other mesh size.
- ANSI/ASME B16.5 Class 150 drilling, contact us.

quotes@tipes.co.uk

PVDF

FILTRE
Strainer

SERIE 4670



N° Fiche produit - Product sheet
TDS-INCL-4640A

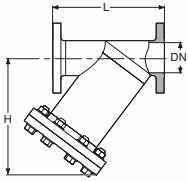

FILTRE EN Y EN PVDF, MAILLE EN ETFE DE 2.0 MM, À BRIDES DIN*
Y strainer in PVDF, mesh size 2.0 mm (ETFE), with DIN* flanges

DIMENSIONS Dimensions					RÉFÉRENCE Product code		
d	DN	G	L	H	EPDM	FPM	PN
mm	mm	inch	mm	mm			bar
75	65	2"1/2	370	260	4670-06FFE20T	4670-06FFV20T	10
90	80	3"	410	275	4670-07FFE20T	4670-07FFV20T	10
110	100	4"	490	325	4670-08FFE20T	4670-08FFV20T	10
140	125	5"	550	380	4670-09FFE20T	4670-09FFV20T	10

* DIN = EN1092-1 PN10/16

- Autre taille de maille, nous consulter.
- Perçage de bride ANSI/ASME B16.5 Class 150, nous consulter.
- Please contact us for other mesh size.
- ANSI/ASME B16.5 Class 150 drilling, contact us.

quotes@tipes.co.uk

FILTRE
Strainer

SERIE 4580



N° Fiche produit - Product sheet
TDS-INCL-4570

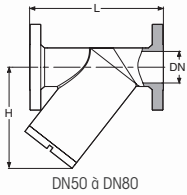

DN50 à DN80

FILTRE EN Y EN PVDF, MAILLE EN ETFE DE 0.4 MM, À BRIDES

Y strainer in PVDF, mesh size 0.4 mm (ETFE), with flanges

DIMENSIONS					RÉFÉRENCE (BRIDES DIN*)	RÉFÉRENCE (BRIDES ANSI*)	
Dimensions					Product code (DIN flanges*)	Product code (ANSI flanges*)	
d	DN	G	L	H	FPM	FPM	PN
mm	mm	inch	mm	mm			bar
75	65	2"1/2	290	236	4580-06FFZ04T	4580-06GGZ04T	10
90	80	3"	310	236	4580-07FFZ04T	4580-07GGZ04T	7
110	100	4"	350	368	4580-08FFZ04T	4580-08GGZ04T	6
140	125	5"	400	356	4580-09FFZ04T	4580-09GGZ04T	5
160	150	6"	480	412	4580-10FFZ04T	4580-10FFZ04T	3
225	200	8"	600	531	4580-11FFZ04T	4580-11GGZ04T	3

* DIN = EN1092-1 PN10

ANSI = ASME B16.5 Class 150

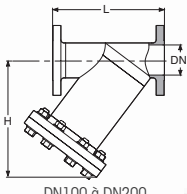

DN100 à DN200

FILTRE EN Y EN PVDF, MAILLE EN ETFE DE 0.8 MM, À BRIDES

Y strainer in PVDF, mesh size 0.8 mm (ETFE), with flanges

DIMENSIONS					RÉFÉRENCE (BRIDES DIN*)	RÉFÉRENCE (BRIDES ANSI*)	
Dimensions					Product code (DIN flanges*)	Product code (ANSI flanges*)	
d	DN	G	L	H	FPM	FPM	PN
mm	mm	inch	mm	mm			bar
75	65	2"1/2	290	236	4580-06FFZ08T	4580-06GGZ08T	10
90	80	3"	310	236	4580-07FFZ08T	4580-07GGZ08T	7
110	100	4"	350	368	4580-08FFZ08T	4580-08GGZ08T	6
140	125	5"	400	356	4580-09FFZ08T	4580-09GGZ08T	5
160	150	6"	480	412	4580-10FFZ08T	4580-10FFZ08T	3
225	200	8"	600	531	4580-11FFZ08T	4580-11GGZ08T	3

* DIN = EN1092-1 PN10

ANSI = ASME B16.5 Class 150

OPTIONS série 4580



Autre taille de maille, nous consulter.
Please contact us for other mesh size.

quotes@tipes.co.uk

FILTRE
Strainer

SERIE 4580



N° Fiche produit - Product sheet
TDS-INCL-4570

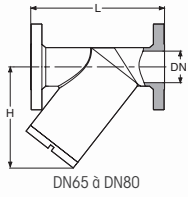

DN65 à DN80

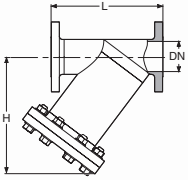

DN100 à DN200

FILTRE EN Y EN PVDF, MAILLE EN ETFE DE 1.0 MM, À BRIDES
Y strainer in PVDF, mesh size 1.0 mm (ETFE), with flanges

DIMENSIONS					RÉFÉRENCE (BRIDES DIN*)	RÉFÉRENCE (BRIDES ANSI*)	
Dimensions					Product code (DIN flanges*)	Product code (ANSI flanges*)	
d	DN	G	L	H	FPM	FPM	PN
mm	mm	inch	mm	mm			bar
75	65	2"1/2	290	236	4580-06FFZ10T	4580-06GGZ10T	10
90	80	3"	310	236	4580-07FFZ10T	4580-07GGZ10T	7
110	100	4"	350	368	4580-08FFZ10T	4580-08GGZ10T	6
140	125	5"	400	356	4580-09FFZ10T	4580-09GGZ10T	5
160	150	6"	480	412	4580-10FFZ10T	4580-10FFZ10T	3
225	200	8"	600	531	4580-11FFZ10T	4580-11GGZ10T	3

* DIN = EN1092-1 PN10

ANSI = ASME B16.5 Class 150

OPTIONS série 4580



Autre taille de maille, nous consulter.
Please contact us for other mesh size.

quotes@tfpes.co.uk

PVDF

Tel: 01626 201092

 www.safi-valves.com

quotes@tipes.co.uk

Fittings

FITTINGS

Tel: 01626 201092



www.safi-valves.com



ROBINETTERIE INDUSTRIELLE - Industrial valves

EMBOUITS - Fittings

SAFI propose une large gamme d'embouts de toutes formes, matières et normes, permettant de connecter ses robinets à tous les types de tuyauterie.

Nous offrons également plusieurs gammes de brides et connecteurs.

Pour une présentation détaillée des différents types d'embouts, vous pouvez vous reporter à la page 16 de ce catalogue.

SAFI offers a wide range of fittings of all shapes, materials and standards, to connect its valves to all types of piping.

We also offer several ranges of flanges and connectors.

For a detailed presentation of the different types of fittings, please refer to page 16 of this catalog.

RACCORDS & EMBOUTS

Fittings

SERIE 2004



N° Fiche produit - Product sheet
TDS-EQUIP-2004

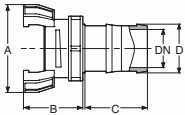

DEMI-RACCORD SYMÉTRIQUE EN PPGF À SORTIE ANNELÉE, FOURNI AVEC JOINT ET VERROU

Quick release coupling in PPGF, hosetail outlet, supplied with o-ring and lock

DIMENSIONS Dimensions						RÉFÉRENCE Product code		
DN	G	A	B	C	D	EPDM	FPM	PS
mm	inch	mm	mm	mm	mm			bar
40	1"1/2	85	55	59	46	2004-03BE	2004-03BV	6
50	2"	85	55	59	52	2004-03DE	2004-03DV	6
50	2"	105	63	59	52	2004-03JE	2004-03JV	6
80	3"	150	77	75	90	2004-03FE	2004-03FV	6
100	4"	178	92	83	112	2004-03HE	2004-03HV	6

DEMI-RACCORD SYMÉTRIQUE EN PPGF À SORTIE FILETÉE PAS DU GAZ CYLINDRIQUE, FOURNI AVEC JOINT ET VERROU

Quick release coupling in PPGF, BSP male outlet, supplied with o-ring and lock

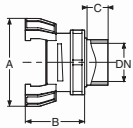

DIMENSIONS Dimensions					RÉFÉRENCE Product code		
DN	G	A	B	C	EPDM	FPM	PS
mm	inch	mm	mm	mm			bar
40	1"1/2	85	55	21	2004-04BE	2004-04BV	6
40	1"1/4	85	70	20	2004-04KE	2004-04KV	6
50	2"	105	63	25	2004-04EE	2004-04EV	6
80	3"	150	77	32	2004-04GE	2004-04GV	6
100	4"	178	92	36	2004-04JE	2004-04JV	6

DEMI-RACCORD SYMÉTRIQUE EN PPGF À SORTIE TARAUDÉE PAS DU GAZ CYLINDRIQUE, FOURNI AVEC JOINT ET VERROU

Quick release coupling in PPGF, BSP female outlet, supplied with o-ring and lock

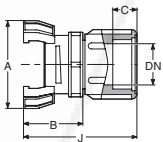

DIMENSIONS Dimensions						RÉFÉRENCE Product code		
DN	G	A	B	C	J	EPDM	FPM	PS
mm	inch	mm	mm	mm	mm			bar
40	1"1/2	85	55	23	110	2004-05BE	2004-05BV	6
50	2"	105	63	25	127	2004-05DE	2004-05DV	6
80	3"	150	77	25	153	2004-05FE	2004-05FV	6
100	4"	178	91	36	184	2004-05HE	2004-05HV	6

BOUCHON PLAT EN PPGF POUR DEMI-RACCORD SYMÉTRIQUE, FOURNI AVEC JOINT, CHAÎNETTE ET ANNEAUX

Blanking plug in PPGF for quick release coupling, supplied with gasket, chain and rings



DIMENSIONS Dimensions		RÉFÉRENCE Product code		
DN	G	EPDM	FPM	PS
mm	inch			bar
40	1"1/2	2004-07BE	2004-07BV	6
50	2"	2004-07DE	2004-07DV	6
80	3"	2004-07FE	2004-07FV	6
100	4"	2004-07HE	2004-07HV	6

quotas@tipes@stjorn

Fittings

RACCORDS & EMBOUTS
Fittings

SERIE 2009



N° Fiche produit - Product sheet
TDS-EQUIP-2009

ADAPTATEUR TARAUDÉ PAS DU GAZ CYLINDRIQUE EN PPGF, TYPE A

PPGF Female BSP threaded adaptor, A type

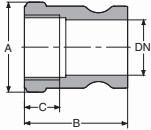

DIMENSIONS Dimensions					RÉFÉRENCE Product code	
DN	G	A	B	C	EPDM	PS
mm	inch	mm	mm	mm		bar
15	1/2"	46	47.5	19.5	2009-00A	6
20	3/4"	46	47.5	19.5	2009-01A	6
25	1"	56	61	24	2009-02A	6
32	1"1/4	67	62.3	24	2009-03A	6
40	1"1/2	73	70.3	25	2009-04A	6
50	2"	86	78	26.5	2009-05A	6
80	3"	117	96	37.5	2009-06A	6

BOUCHON FEMELLE EN PPGF, TYPE DC

Female dust cap, DC type

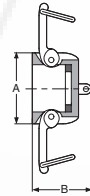

DIMENSIONS Dimensions				RÉFÉRENCE Product code	
DN	G	A	B	EPDM	PS
mm	mm	mm	mm		bar
15	1/2"	56	46	2009-00HE	6
20	3/4"	54	46	2009-01HE	6
25	1"	62	51	2009-02HE	6
32	1"1/4	63	51	2009-03HE	6
40	1"1/2	84	60	2009-04HE	6
50	2"	94	66	2009-05HE	6
80	3"	133	73	2009-06HE	6

ADAPTATEUR ANNELÉ EN PPGF, TYPE E

PPGF hose tail adaptor, E type

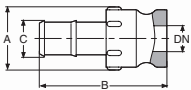

DIMENSIONS Dimensions					RÉFÉRENCE Product code	
DN	G	A	B	C	EPDM	PS
mm	inch	mm	mm	mm		bar
15	1/2"	41	77.5	13.5	2009-00E	6
20	3/4"	41	78	20	2009-01E	6
25	1"	46	99.5	26	2009-02E	6
32	1"1/4	53.5	111	32.5	2009-03E	6
40	1"1/2	63	112	40	2009-04E	6
50	2"	71	131	52	2009-05E	6
80	3"	107	174	79	2009-06E	6

ADAPTATEUR FILETÉ PAS DU GAZ CYLINDRIQUE EN PPGF, TYPE F

PPGF Male BSP threaded adaptor, F type

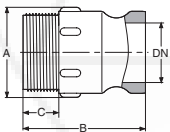

DIMENSIONS Dimensions					RÉFÉRENCE Product code	
DN	G	A	B	C	EPDM	PS
mm	inch	mm	mm	mm		bar
15	1/2"	36	52	14	2009-00F	6
20	3/4"	36	53	15	2009-01F	6
25	1"	42.5	68.5	20.5	2009-02F	6
32	1"1/4	50	72.5	23	2009-03F	6
40	1"1/2	58	81	23	2009-04F	6
50	2"	68	92.5	27	2009-05F	6
80	3"	98	104	32.5	2009-06F	6

quotes@tipes.co.uk

Fittings

RACCORDS & EMBOUTS
Fittings

SERIE 2009



N° Fiche produit - Product sheet
TDS-EQUIP-2009

COUPLEUR FILETÉ PAS DU GAZ CYLINDRIQUE EN PPGF, TYPE B

PPGF Male BSP threaded coupler, B type

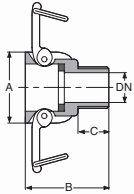

DIMENSIONS Dimensions					RÉFÉRENCE Product code	
DN	G	A	B	C	EPDM	PS bar
mm	inch	mm	mm	mm		
15	1/2"	56	61	14	2009-00BE	6
20	3/4"	56	62.5	15	2009-01BE	6
25	1"	62	75.5	20.5	2009-02BE	6
32	1"1/4	63	79.5	23	2009-03BE	6
40	1"1/2	89	71	24	2009-04BE	6
50	2"	94	100	27	2009-05BE	6
80	3"	130	112	32	2009-06BE	6

COUPLEUR ANNELÉ EN PPGF, TYPE C

PPGF hosetail coupler, C type

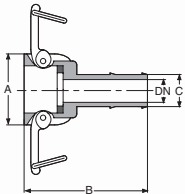

DIMENSIONS Dimensions					RÉFÉRENCE Product code	
DN	G	A	B	C	EPDM	PS bar
mm	inch	mm	mm	mm		
15	1/2"	56	87	13	2009-00CE	6
20	3/4"	55	75.2	21.5	2009-01CE	6
25	1"	62	106	26	2009-02CE	6
32	1"1/4	63	118	32	2009-03CE	6
40	1"1/2	84	127	39	2009-04CE	6
50	2"	94	139	51.5	2009-05CE	6
80	3"	128	166	77	2009-06CE	6

COUPLEUR TARAUDÉ PAS DU GAZ CYLINDRIQUE EN PPGF, TYPE D

PPGF Female BSP threaded coupler, D type

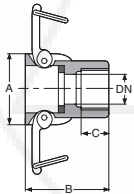

DIMENSIONS Dimensions					RÉFÉRENCE Product code	
DN	G	A	B	C	EPDM	PS bar
mm	inch	mm	mm	mm		
15	1/2"	56	57	19	2009-00DE	6
20	3/4"	55	55	21	2009-01DE	6
25	1"	62	67	23	2009-02DE	6
32	1"1/4	67.5/63	69	25	2009-03DE	6
40	1"1/2	84	78	25	2009-04DE	6
50	2"	94	85	26	2009-05DE	6
80	3"	134	91	33	2009-06DE	6

quotes@tipes.com.uk

Fittings

RACCORDS & EMBOUTS

Fittings

SERIE 2019



N° Fiche produit - Product sheet
TDS-EQUIP-2019

BRIDE FOLLE EN PPGF AVEC RENFORT ACIER

Steel reinforced PPGF stub flange

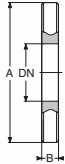

DIMENSIONS							RÉFÉRENCE (DIN*)	RÉFÉRENCE (ANSI*)
Dimensions								
d	DN	G	DIN*		ANSI*		Product code (DIN *)	Product code (ANSI*)
			A	B	A	B		
mm	mm	inch	mm	mm	mm	mm		
20	15	1/2"	95	12	95	12	2019-10T	2019A10T
25	20	3/4"	105	12	105	12	2019-11T	2019A11T
32	25	1"	116	16.5	112	16	2019-12T	2019A12T
40	32	1"1/4	140	18	130	16	2019-13T	2019A13T
50	40	1"1/2	150	18	132	18	2019-14T	2019A14T
63	50	2"	165	17	160	18	2019-15T	2019A15T
75	65	2"1/2	188	22	178	18	2019-16T	2019A16T
90	80	3"	199	21	190	18	2019-17T	2019A17T
110	100	4"	225	21	229	18	2019-18T	2019A18T
140	125	5"	250	24	-	-	2019-19T	2019A19T
160	150	6"	285	24	279	24	2019-20T	2019A20T
225	200	8"	340	24	-	-	2019-21T	2019A21T
250	250	10"	405	30	406	34	2019-22T	2019A22T
315	300	12"	460	34	483	34	2019-23T	2019A23T

* DIN = EN1092-1 PN10

ANSI = ASME B16.5 Class 150

SERIE 2003



N° Fiche produit - Product sheet
TDS-EQUIP-2003

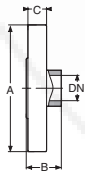
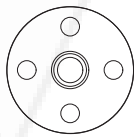

BRIDE TARAUDÉE PAS DU GAZ CYLINDRIQUE EN PPGF

BSP threaded PPGF flange

DIMENSIONS						RÉFÉRENCE (DIN*)	RÉFÉRENCE (ANSI*)
Dimensions							
d	DN	G	A	B	C	Product code (DIN *)	Product code (ANSI*)
mm	mm	inch	mm	mm	mm		
20	15	1/2"	95	25	14	2003-00K	**
25	20	3/4"	105	26	15	2003-01K	**

* DIN = EN1092-1 PN10/16

ANSI = ASME B16.5 Class 150

** Nous consulter

** Consult us

RACCORDS & EMBOUTS
Fittings

SERIE 2042



N° Fiche produit - Product sheet
TDS-EQUIP-2003

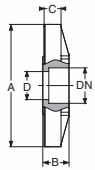
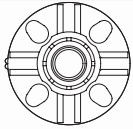

BRIDE TARAUDÉE PAS DU GAZ CYLINDRIQUE EN PPGF, COMPATIBLE DIN/ANSI/BS

BSP threaded PPGF flange, DIN/ANSI/BS slotted

DIMENSIONS Dimensions							RÉFÉRENCE Product code
d	DN	G	A	B	C	D	
mm	mm	inch	mm	mm	mm	mm	
32	25	1"	115.5	22.5	16	26	2042-020
40	32	1 1/4"	140	27.5	18	32	2042-030
50	40	1 1/2"	150	31.5	18	40	2042-040
63	50	2"	165	42	18.5	50	2042-050

* DIN = EN1092-1 PN10/16

ANSI = ASME B16.5 Class 150

SERIE 1003



N° Fiche produit - Product sheet
TDS-EQUIP-1003

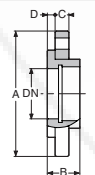
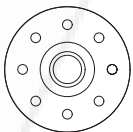

BRIDE FOLLE EN PPGF AVEC RENFORT ACIER ET COLLET PPGF TARAUDÉ PAS DU GAZ CYLINDRIQUE

Steel reinforced PPGF stub flange with BSP threaded PPGF socket

DIMENSIONS Dimensions							RÉFÉRENCE (DIN*) Product code (DIN *)	
d	DN	G	A	B	C	D	EPDM	FPM
mm	mm	inch	mm	mm	mm	mm		
90	80	3"	199	52	21	12.5	1003-33ITE	1003-33ITV
110	100	4"	225	72	21	14	1003-34ITE	1003-34ITV

* DIN = EN1092-1 PN10/16

quotes@tipes.co.uk

RACCORDS & EMBOUTS

Fittings

SERIE 3401



N° Fiche produit - Product sheet
TDS-EQUIP-3401

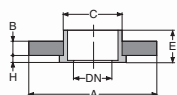
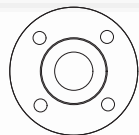

BRIDE FOLLE EN PVC-U

PVC-U stub flange

DIMENSIONS Dimensions						RÉFÉRENCE (DIN*) Product code (DIN *)	RÉFÉRENCE (ANSI*) Product code (ANSI*)
d	DN	G	A	B	C		
mm	mm	inch	mm	mm	mm		
20	15	1/2"	95	12	27.5	3401D00B	3401A00B
25	20	3/4"	105	12	34	3401D01B	3401A01B
32	25	1"	115	14.5	42	3401D02B	3401A02B
40	32	1"1/4	143	15	50.5	3401D03B	3401A03B
50	40	1"1/2	150	16	62.5	3401D04B	3401A04B
63	50	2"	165	18	78.5	3401D05B	3401A05B
75	65	2"1/2	187.5	18.5	91	3401D06B	3401A06B
90	80	3"	202	20	111	3401D07B	3401A07B
110	100	4"	220	24	133	3401D08B	3401A08B

* DIN = EN1092-1 PN10

ANSI = ASME B16.5 Class 150

COLLET DE BRIDE FEMELLE EN PVC-U

PVC-U plain socket

DIMENSIONS Dimensions					RÉFÉRENCE Product code
d	DN	G	E	H	
mm	mm	inch	mm	mm	
20	15	1/2"	25	6.5	3401-00P
25	20	3/4"	28.5	7.5	3401-01P
32	25	1"	33.5	7.5	3401-02P
40	32	1"1/4	43.5	8.5	3401-03P
50	40	1"1/2	44	9.5	3401-04P
63	50	2"	43.5	10.5	3401-05P
75	65	2"1/2	56.5	10.5	3401-06P
90	80	3"	63	11	3401-07P
110	100	4"	74.5	12	3401-08P

quotes@tipes.co.uk

Fittings

RACCORDS & EMBOUTS

Fittings

FITTINGS



N° Fiche produit - Product sheet
TDS-EQUIP-3101

Ces embouts se montent sur les robinets des séries 3101, 3111, 3150.
Those connections are mounted on union-type valves of the following series : 3101, 3111, 3150.

EMBOUT TARAUDÉ PAS DU GAZ CYLINDRIQUE

BSP threaded socket

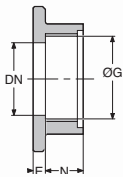

DIMENSIONS							RÉFÉRENCE		
Dimensions							Product code		
G	DN	PVC			PP-H		PVC-U	PVC-C	PP-H
		E	L1	N	L1	N			
inch	mm	mm	mm	mm	mm	mm			
3/8"	10	4.5	25.5	22.5	24	21	3101-99A	3111-99A	3150-99A
1/2"	15	4.5	25.5	22.5	24	21	3101-00A	3111-00A	3150-00A
3/4"	20	4.5	28	25.5	28	24	3101-01A	3111-01A	3150-01A
1"	25	5.5	33.5	29	32.5	27	3101-02A	3111-02A	3150-02A
1"1/4	32	6.5	43.5	35	43	30.5	3101-03A	3111-03A	3150-03A
1"1/2	40	6	43.5	36	43	32.5	3101-04A	3111-04A	3150-04A
2"	50	6.5	43.5	38	43	35	3101-05A	3111-05A	3150-05A
2"1/2	65	11.5	56.5	45	54	42	3101-06A	3111-06A	3150-06A
3"	80	14	62.5	48.5	61	46.5	3101-07A	3111-07A	3150-07A
4"	100	15.5	73	53.5	72	54	3101-08A	3111-08A	3150-08A

EMBOUT FEMELLE MÉTRIQUE

Metric socket

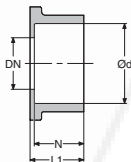

DIMENSIONS							RÉFÉRENCE		
Dimensions							Product code		
d	DN	G	PVC		PP-H		PVC-U	PVC-C	PP-H
			L1	N	L1	N			
mm	mm	inch	mm	mm	mm	mm			
15	10	3/8"	25	15	24	14.5	3101-99B	3111-99B	3150-99C
20	15	1/2"	25	17	24	14.5	3101-00B	3111-00B	3150-00C
25	20	3/4"	28	18.5	28	17	3101-01B	3111-01B	3150-01C
32	25	1"	33	21	32.5	22	3101-02B	3111-02B	3150-02C
40	32	1"1/4	43	26	42.5	22	3101-03B	3111-03B	3150-03C
50	40	1"1/2	43.5	35	42.5	26	3101-04B	3111-04B	3150-04C
63	50	2"	43.5	38	43	31	3101-05B	3111-05B	3150-05C
75	65	2"1/2	56	45	54.5	31	3101-06B	3111-06B	3150-06C
90	80	3"	62	51	60.5	34.5	3101-07B	3111-07B	3150-07C
110	100	4"	74	61	70	45	3101-08B	3111-08B	3150-08C

RACCORDS & EMBOUTS

Fittings

FITTINGS



N° Fiche produit - Product sheet
TDS-EQUIP-3101

Ces embouts se montent sur les robinets des séries 3101, 3111, 3150.
Those connections are mounted on union-type valves of the following series : 3101, 3111, 3150.

ENSEMBLE COMPOSÉ DE BRIDE EN1092-1 PN10/16 («DIN») ÉCROU ET EMBOUT

Assembly of «DIN» flange (EN1092-1 PN10/16), nut and socket

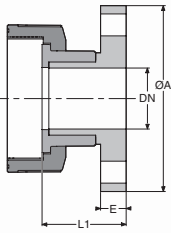

DIMENSIONS Dimensions								RÉFÉRENCE Product code		
d	DN	G	ØA	E	PVC L1	PP-H L1	PVC-U	PVC-C	PP-H	
mm	mm	inch	mm	mm	mm	mm				
20	15	1/2"	95	15	45	44.5	3101-00F	3111-00F	3150-00F	
25	20	3/4"	105	15.5	48.5	46	3101-01F	3111-01F	3150-01F	
32	25	1"	115	17	57	53	3101-02F	3111-02F	3150-02F	
40	32	1 1/4"	140	17	66.5	59	3101-03F	3111-03F	3150-03F	
50	40	1 1/2"	150	19	66.5	66	3101-04F	3111-04F	3150-04F	
63	50	2"	165	21	70	68	3101-05F	3111-05F	3150-05F	
75	65	2 1/2"	185	21	82.5	80.5	3101-06F	3111-06F	3150-06F	
90	80	3"	200	22	94	88	3101-07F	3111-07F	3150-07F	
110	100	4"	220	22	101.5	97.8	3101-08F	3111-08F	3150-08F	

EMBOU TARAUDÉ NPT

NPT threaded socket

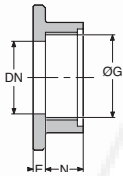

DIMENSIONS Dimensions					RÉFÉRENCE Product code		
G	DN	E	L1	N	PVC-U	PVC-C	PP-H
inch	mm	mm	mm	mm			
3/8" NPT	10	4.5	25	24.5	3101-99K	3111-99K	sur demande
1/2" NPT	15	4.5	25	23	3101-00K	3111-00K	sur demande
3/4" NPT	20	4.5	28.5	25.5	3101-01K	3111-01K	sur demande
1" NPT	25	5.5	33	28.5	3101-02K	3111-02K	sur demande
1 1/4" NPT	32	6.5	43.5	35	3101-03K	3111-03K	sur demande
1 1/2" NPT	40	6	43.5	36	3101-04K	3111-04K	sur demande
2" NPT	50	6.5	43.5	38.5	3101-05K	3111-05K	sur demande
2 1/2" NPT	65	11.5	56.5	44.5	3101-06K	3111-06K	sur demande
3" NPT	80	14	63	50	3101-07K	3111-07K	sur demande
4" NPT	100	15.5	73	56	3101-08K	3111-08K	sur demande

quotes@tipes.co.uk

Fittings

RACCORDS & EMBOUTS

Fittings

FITTINGS



N° Fiche produit - Product sheet
TDS-EQUIP-3101

Ces embouts se montent sur les robinets des séries 3101, 3111, 3150.
Those connections are mounted on union-type valves of the following series : 3101, 3111, 3150.

EMBOUT FEMELLE SCHEDULE 80

Schedule 80 socket

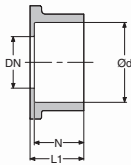

DIMENSIONS Dimensions				RÉFÉRENCE Product code		
DN	Ød	L1	N	PVC-U	PVC-C	PP-H
mm	mm	mm	mm			
10	17.4	25	20	3101-99Z	3111-99Z	sur demande
15	21.3	25	22.5	3101-00Z	3111-00Z	sur demande
20	26.6	28.5	26	3101-01Z	3111-01Z	sur demande
25	33.4	33.5	28.5	3101-02Z	3111-02Z	sur demande
32	42.1	43.5	31.5	3101-03Z	3111-03Z	sur demande
40	48.2	44	36	3101-04Z	3111-04Z	sur demande
50	60.3	43.5	39.5	3101-05Z	3111-05Z	sur demande
65	73	56.5	44.5	3101-06Z	3111-06Z	sur demande
80	88.9	63	48	3101-07Z	3111-07Z	sur demande
100	101.6	74.5	57	3101-08Z	3111-08Z	sur demande

ENSEMBLE COMPOSÉ DE BRIDE ASME B16.5 CLASS 150 ("ANSI"), ÉCROU ET EMBOUT

Assembly of "ANSI" flange (ASME B16.5 Class 150), nut and socket

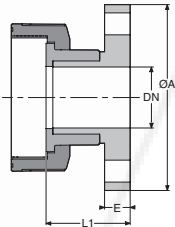

DIMENSIONS Dimensions						RÉFÉRENCE Product code		
DN	G	ØA	E	PVC L1	PP-H L1	PVC-U	PVC-C	PP-H
mm	inch	mm	mm	mm	mm			
15	1/2"	89	15	45	44	3101A00F	3111A00F	3150A00F
20	3/4"	98.4	15.5	48.5	46	3101A01F	3111A01F	3150A01F
25	1"	108	17	57	53	3101A02F	3111A02F	3150A02F
32	1 1/4"	117.5	17	66.5	59	3101A03F	3111A03F	3150A03F
40	1 1/2"	127	19	66.5	66	3101A04F	3111A04F	3150A04F
50	2"	152.4	21	69.5	68	3101A05F	3111A05F	3150A05F
65	2 1/2"	177.8	21	82.5	75	3101A06F	3111A06F	3150A06F
80	3"	190.5	22	94	88	3101A07F	3111A07F	3150A07F
100	4"	228.6	22	101.5	98.5	3101A08F	3111A08F	3150A08F

EMBOUT PE-HD MÂLE ÉLECTROSOUDABLE, MÉTRIQUE

PE-HD metric spigot for electrofusion

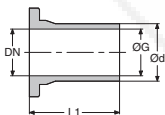

DIMENSIONS Dimensions				RÉFÉRENCE Product code
d	DN	G	L1	
mm	mm	inch	mm	
20	15	1/2"	84,5	2024Z00V
25	20	3/4"	83,5	2024Z01V
32	25	1"	88	2024Z02V
40	32	1 1/4"	91	2024U03V
50	40	1 1/2"	88	2024Z04V
63	50	2"	110	2024Z05V
75	65	2 1/2"	127	2024Z06V
90	80	3"	136,5	2024Z07V
110	100	4"	156,5	2024Z08V

RACCORDS & EMBOUTS

Fittings

FITTINGS



N° Fiche produit - Product sheet
TDS-EQUIP-1003

Ces embouts se montent sur robinets et clapets PPGF et PVDF séries 1003, 2001, 2003, 2027, 2035, 2038, 2068.
Those connections are mounted on valves in PPGF and PVDF series 1003, 2001, 2003, 2027, 2035, 2038, 2068.

EMBOUT PPGF TARAUDÉ PAS DU GAZ CYLINDRIQUE

PPGF BSP threaded socket

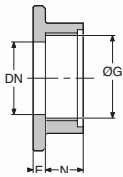

DIMENSIONS					RÉFÉRENCE
Dimensions					
G	DN	E	L1	N	
inch	mm	mm	mm	mm	
1/2"	15	5	22.5	17.5	2016-00E
3/4"	20	5	25.5	20.5	2016-01E
1"	25	6	28	23.5	1003-02E
1"1/4	32	7	32	27.5	1003-03E
1"1/2	40	8	32	24.5	1003-04E
2"	50	9	34.5	24.5	1003-05E

EMBOUT PVC-U FEMELLE MÉTRIQUE

PVC-U metric socket

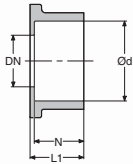

DIMENSIONS					RÉFÉRENCE
Dimensions					
d	DN	G	L1	N	
mm	mm	inch	mm	mm	
20	15	1/2"	21	16.5	2016-00P
25	20	3/4"	24.5	20	2016-01P
32	25	1"	26.5	22.5	1003-02P
40	32	1"1/4	31	27.5	1003-03P
50	40	1"1/2	37.5	31.5	1003-04P
63	50	2"	44	38	1003-05P

EMBOUT PP-H FEMELLE MÉTRIQUE

PP-H metric socket

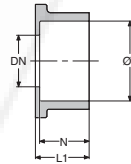

DIMENSIONS					RÉFÉRENCE
Dimensions					
d	DN	G	L1	N	
mm	mm	inch	mm	mm	
20	15	1/2"	21	17	2016-00Z
25	20	3/4"	22.5	18	2016-01Z
32	25	1"	24	20	1003-02Z
40	32	1"1/4	27	22	1003-03Z
50	40	1"1/2	30.5	25	1003-04Z
63	50	2"	35.5	29.5	1003-05Z

EMBOUT PE-HD FEMELLE MÉTRIQUE

PE-HD metric socket

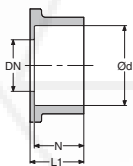

DIMENSIONS					RÉFÉRENCE
Dimensions					
d	DN	G	L1	N	
mm	mm	inch	mm	mm	
20	15	1/2"	20.5	16.5	2024-00B
25	20	3/4"	22.5	18	2024-01B
32	25	1"	23.5	20	2024-02B
40	32	1"1/4	26	22	2024-03B
50	40	1"1/2	30	25	2024-04B
63	50	2"	35	29.5	2024-05B

EMBOUT ABS FEMELLE MÉTRIQUE

ABS metric socket

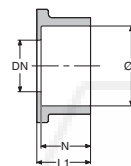

DIMENSIONS					RÉFÉRENCE
Dimensions					
d	DN	G	L1	N	
mm	mm	inch	mm	mm	
20	15	1/2"	23.5	20	2024-00M
25	20	3/4"	23.5	20	2024-01M
32	25	1"	27	23	2024-02M
40	32	1"1/4	32	27	2024-03M
50	40	1"1/2	38	32	2024-04M
63	50	2"	44	37	2024-05M

quotes@tipes.co.uk

Fittings

RACCORDS & EMBOUTS

Fittings

FITTINGS



N° Fiche produit - Product sheet
TDS-EQUIP-1003

Ces embouts se montent sur robinets et clapets PPGF et PVDF séries 1003, 2001, 2003, 2027, 2035, 2038, 2068.
Those connections are mounted on valves in PPGF and PVDF series 1003, 2001, 2003, 2027, 2035, 2038, 2068.

EMBOU PPGF CAMLOCK

PPGF camlock spigot

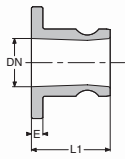
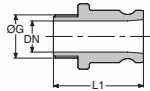

DIMENSIONS					RÉFÉRENCE
Dimensions					
d	DN	G	E	L1	
mm	mm	inch	mm	mm	
20	15	1/2"	-	51.6	2009-00F *
25	20	3/4"	-	52.7	2009-01F *
32	25	1"	5	46	1005-15k
40	32	1"1/4	7	55	1005-14K
50	40	1"1/2	9	61.5	1005-13K
63	50	2"	9	63	1005-45K

* Ces références se montent sur un robinet avec embouts taraudés
* Those parts are mounted on a valve with threaded sockets.

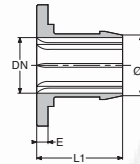
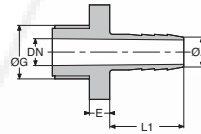

EMBOU PPGF MÂLE POUR TUYAU SOUPLE

PPGF hositail spigot

DIMENSIONS					RÉFÉRENCE
Dimensions					
DN	G	ØA	L1	E	
mm	inch	mm	mm	mm	
15	1/2"	14	29	8	1062-16G *
20	3/4"	20	37	8	1062-16L *
25	1"	25	68	8	1005-47T
32	1"1/4	30	68	8	1005-39T
40	1"1/2	40	68	9	1005-13T
50	2"	50	68	9	1005-45T

* Ces références se montent sur un robinet avec embouts taraudés
* Those parts are mounted on a valve with threaded sockets.

EMBOU PE-HD MÂLE ÉLECTROSOUDABLE,

SDR11, MÉTRIQUE

PE-HD metric spigot SDR11 for electrofusion

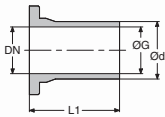

DIMENSIONS				RÉFÉRENCE
Dimensions				
d	DN	G	L1	
mm	mm	inch	mm	
20	15	1/2"	85	2024U00V
25	20	3/4"	85	2024U01V
32	25	1"	88	2024U02V
40	32	1"1/4	90	2024U03V
50	40	1"1/2	88	2024U04V
63	50	2"	110	2024U05V

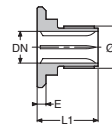
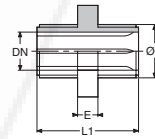

EMBOU PPGF FILETÉ PAS DU GAZ

CYLINDRIQUE

PPGF BSP threaded spigot

DIMENSIONS					RÉFÉRENCE
Dimensions					
d	DN	G	L1	E	
mm	mm	inch	mm	mm	
20	15	1/2"	40,5	8	1003-00Q *
25	20	3/4"	40,5	8	1003-01Q *
32	25	1"	48	7.5	1003-02H
40	32	1"1/4	48	7.5	1003-03H
50	40	1"1/2	48	7.5	1003-04H
63	50	2"	48,5	10	1003-05H

* Ces références se montent sur un robinet avec embouts taraudés
* Those parts are mounted on a valve with threaded sockets.

ENSEMBLE EN PPGF COMPOSÉ DE BRIDE DIN/ANSI*,

ÉCROU, EMBOUT ET JOINT

Assembly of PPGF DIN/ANSI* flange, nut, socket and o-ring

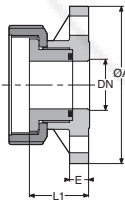

DIMENSIONS					RÉFÉRENCE	
Dimensions					Product code	
DN	G	ØA	E	L1	Joint	Joint
mm	inch	mm	mm	mm	EPDM	FPM
15	1/2"	-	-	-	**	**
20	3/4"	-	-	-	**	**
25	1"	115	15.5	40	2018D22EP	2018D22VT
32	1"1/4	140	18	47.5	2018D23EP	2018D23VT
40	1"1/2	150	17	49.5	2018D24EP	2018D24VT
50	2"	165	19	63	2018D25EP	2018D25VT
65	2"1/2	185	19	92	2018D26EP	2018D26VT

* DIN = EN1092-1 PN10/16
** Nous consulter.
** Consult us.

ANSI = ASME B16.5 Class 150

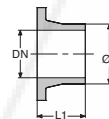

EMBOU PP-H MÂLE MÉTRIQUE

PP-H metric spigot

DIMENSIONS				RÉFÉRENCE
Dimensions				
d	DN	G	L1	
mm	mm	inch	mm	
20	15	1/2"	49.5	2016-00F
25	20	3/4"	49.5	2016-01F
32	25	1"	49	2016-02F
40	32	1"1/4	49	2016-03F
50	40	1"1/2	48	2016-04F
63	50	2"	48	2016-05F

RACCORDS & EMBOUTS

Fittings

FITTINGS



N° Fiche produit - Product sheet
TDS-EQUIP-1003

Ces embouts se montent sur robinets et clapets PPGF et PVDF séries 1003, 2001, 2003, 2027, 2035, 2038, 2068.
Those connections are mounted on valves in PPGF and PVDF series 1003, 2001, 2003, 2027, 2035, 2038, 2068.

EMBOU PPGF TARAUDÉ FNPT

PPGF FNPT threaded socket

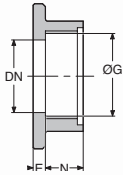

DIMENSIONS Dimensions					RÉFÉRENCE Product code
G	DN	E	L1	N	
inch	mm	mm	mm	mm	
1/2"	15	5	22.5	17.5	2016-00E
3/4"	20	5	25.5	20.5	2016-01E
1"	25	6	23	17	2003-02E
1"1/4	32	7	24	17	2003-03E
1"1/2	40	8	24	17	2003-04E
2"	50	9	32	22	2003-05E

EMBOU PVC-U FEMELLE BS

PVC-U Imperial socket

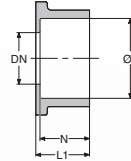

DIMENSIONS Dimensions					RÉFÉRENCE Product code
d	DN	G	L1	N	
mm	mm	inch	mm	mm	
21,5	15	1/2"	22	17	2003-10U
26,8	20	3/4"	22	20	2003-11U
33,6	25	1"	26	22	2003-02U
42,4	32	1"1/4	32	27	2003-03U
48,5	40	1"1/2	37	30	2003-04U
60,6	50	2"	44	37	2003-05U

EMBOU PVDF TARAUDÉ PAS DU GAZ CYLINDRIQUE

PVDF BSP threaded socket

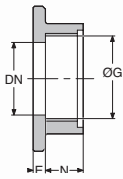

DIMENSIONS Dimensions					RÉFÉRENCE Product code
G	DN	E	L1	N	
inch	mm	mm	mm	mm	
1/2"	15	-	22.5	17.5	2027-10E
3/4"	20	-	25.5	20.5	2027-11E
1"	25	6.5	29	22	2027-02E
1"1/4	32	7	30	24	2027-03E
1"1/2	40	8	31	24	2027-04E
2"	50	9	32.5	24	2027-05E

EMBOU PVDF FEMELLE MÉTRIQUE

PVDF metric socket

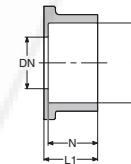

DIMENSIONS Dimensions					RÉFÉRENCE Product code
d	DN	G	L1	N	
mm	mm	inch	mm	mm	
20	15	1/2"	21.5	17	2027-10Z
25	20	3/4"	22.5	18	2027-11Z
32	25	1"	24.5	20	2027-02Z
40	32	1"1/4	26	22	2027-03Z
50	40	1"1/2	31	25	2027-04Z
63	50	2"	36	29.5	2027-05Z

ENSEMBLE EN PVDF COMPOSÉ DE BRIDE DIN/ANSI*, ÉCROU, EMBOUT ET JOINT FPM

Assembly of PVDF DIN/ANSI* flange, nut, socket and FPM o-ring

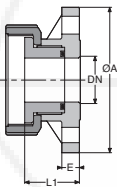

DIMENSIONS Dimensions					RÉFÉRENCE Product code
DN	G	ØA	E	L1	
mm	inch	mm	mm	mm	
15	1/2"	-	-	-	**
20	3/4"	-	-	-	**
25	1"	115	15.5	41	2027-02U
32	1"1/4	140	18	47	2027-03U
40	1"1/2	150	17	50.5	2027-04U
50	2"	165	19	60.5	2027-05U

* DIN = EN1092-1 PN10/16

ANSI = ASME B16.5 Class 150

** Nous consulter.

** Consult us.

OPTIONS

Tel: 01626 201092





notes@tfpes.co.uk

ROBINETTERIE INDUSTRIELLE - Industrial valves

OPTIONS ET ACCESSOIRES - Options and accessories

SAFI offre de nombreux accessoires, options et pièces de rechange sur ses principales gammes de robinets.

Pour une personnalisation plus poussée, n'hésitez pas à nous contacter.

SAFI offers many accessories, options and spare parts on its main ranges of valves.

For further customization, do not hesitate to contact us.

Options

OPTIONS & ACCESSOIRES

Options & accessories

OPTIONS



N° Fiche produit - Product sheet
TDS-EQUIP-0009

Le trou de dégazage dans la sphère est obligatoire pour les fluides susceptibles de dégazer comme le peroxyde d'hydrogène ou l'hypochlorite de sodium.
The gaz release hole in the ball is compulsory for fluids which can release gaz, such as hydrogen peroxyde or sodium hypochlorite.



TROU DE DÉGAZAGE DANS LA SPHÈRE D'UN ROBINET À TOURNANT SPHÉRIQUE
Gaz release hole in the ball of ball valve

DIMENSIONS Dimensions			RÉFÉRENCE Product code	DIAMÈTRE DU PERÇAGE (MM) Hole diameter (mm)
d mm	DN mm	G inch		
20	15	1/2"	2025-11S	8
25	20	3/4"	2025-11S	8
32	25	1"	2025-11T	14
40	32	1"1/4	2025-11T	14
50	40	1"1/2	2025-11U	16
63	50	2"	2025-11U	16
75	65	2"1/2	2025-11U	16
90	80	3"	2025-11V	20
110	100	4"	2025-11V	20
125	125	5"	2025-11W	20
160	150	6"	2025-11W	20

Pour commander un robinet avec perçage de dégazage, rajouter la référence à la fin du robinet. Par exemple 2014-05FFE + 2025-11U.

To order a ball valve with a gaz release hole, add the product code at the end of the code of the valve. For example 2014-05FFE + 2025-11U.



N° Fiche produit - Product sheet
TDS-BALL-2014

POIGNÉE CADENASSABLE POUR ROBINET À TOURNANT SPHÉRIQUE À BRIDES :
SÉRIES 2014, 2016, 2008 (PPGF), 2029 (PVDF), 2091 (PP-EL)

Lockable handle for flanged ball valve : series 2014, 2016, 2008 (PPGF), 2029 (PVDF), 2091 (PP-EL)

DIMENSIONS Dimensions			RÉFÉRENCE Product code		
d mm	DN mm	G inch	EPDM	FPM	SÉRIE 2091
20	15	1/2"	1102-06RTR	1102-06RTV	1102-06RTN
25	20	3/4"	1102-06RTR	1102-06RTV	1102-06RTN
32	25	1"	1102-06STR	1102-06STV	1102-06STN
40	32	1"1/4	1102-06STR	1102-06STV	1102-06STN
50	40	1"1/2	1102-06UTR	1102-06UTV	1102-06UTN
63	50	2"	1102-06UTR	1102-06UTV	1102-06UTN
75	65	2"1/2	N/A	N/A	N/A
90	80	3"	*	*	*
110	100	4"	*	*	*
160	150	6"	1102-06	1102-06	N/A

* Cadenassage de série
* Standard lockable handle

Pour commander un robinet avec poignée cadénassable, rajouter la référence à la fin du robinet. Par exemple 2014-05FFV + 1102-06UTV.

To order a ball valve with a lockable handle, add the product code at the end of the code of the valve. For example 2014-05FFV + 1102-06UTV.

OPTIONS & ACCESSOIRES

Options & accessories

OPTIONS

N° Fiche produit - Product sheet
TDS-BALL-1003**POIGNÉE CADENASSABLE POUR ROBINET À TOURNANT SPHÉRIQUE DOUBLE UNION 2 VOIES :
SÉRIES 1003 (PPGF), 2027 (PVDF)**

Lockable handle for 2-way double-union ball valve : series 1003 (PPGF), 2027 (PVDF)

DIMENSIONS Dimensions			RÉFÉRENCE Product code	
d	DN	G	EPDM	FPM
mm	mm	inch		
20	15	1/2"	1102-06RTR	1102-06RTV
25	20	3/4"	1102-06RTR	1102-06RTV
32	25	1"	1102-06PTR	1102-06PTV
40	32	1"1/4	1102-06PTR	1102-06PTV
50	40	1"1/2	1102-06QTR	1102-06QTV
63	50	2"	1102-06QTR	1102-06QTV

**POIGNÉE CADENASSABLE POUR ROBINET À TOURNANT SPHÉRIQUE DOUBLE UNION 3 VOIES :
SÉRIES 2003 (PPGF), 2035 (PVDF)**

Lockable handle for 3-way double-union ball valve : series 2003 (PPGF), 2035 (PVDF)

DIMENSIONS Dimensions			RÉFÉRENCE Product code	
d	DN	G	EPDM	FPM
mm	mm	inch		
20	15	1/2"	1102-06RTR	1102-06RTV
25	20	3/4"	1102-06RTR	1102-06RTV
32	25	1"	1102-06MTR	1102-06MTV
40	32	1"1/4	1102-06MTR	1102-06MTV
50	40	1"1/2	1102-06NTR	1102-06NTV
63	50	2"	1102-06NTR	1102-06NTV

Pour commander un robinet avec poignée cadénassable, rajouter la référence à la fin du robinet. Par exemple 1003-05AAE + 1102-06QTR.

Pour les robinets 3 voies, seules les versions avec sphère en double L peuvent être équipées d'une poignée cadénassable.

To order a ball valve with a lockable handle, add the product code at the end of the code of the valve. For example 1003-05AAE + 1102-06QTR.

For 3-way valves, only the versions with a double L port can be equipped with a lockable handle.

OPTIONS & ACCESSOIRES

Options & accessories

OPTIONS

N° Fiche produit - Product sheet
TDS-DIAPH-2300/3200

MEMBRANE POUR ROBINET À MEMBRANE

Diaphragm for diaphragm valve

DIMENSIONS Dimensions			RÉFÉRENCE Product code		
d mm	DN mm	G inch	EPDM	FPM	PTFE
20	15	1/2"	2100-02C	2100-02F	2100-02E
25	20	3/4"	2100-02C	2100-02F	2100-02E
32	25	1"	2100-02C	2100-02F	2100-02E
40	32	1"1/4	2100-04C	2100-04F	2100-04E
50	40	1"1/2	2100-04C	2100-04F	2100-04E
63	50	2"	2100-05C	2100-05F	2100-05E
75	65	2"1/2	3200-06E	-	3200-06P
90	80	3"	3200-07E	-	3200-07P
110	100	4"	3200-08E	-	3200-08P
125	125	5"	3200-09E	-	3200-09P
160	150	6"	3200-10E	-	3200-10P
225	200	8"	3200-11E	-	3200-11P
280	250	10"	3200-12E	-	3200-12P

L'entretien de nos robinets doit se faire suivant nos procédures disponibles sur demande.
The maintenance of our valves must be carried out following our procedures, which are available on demand.

CADENASSAGE POUR VOLANT DE ROBINET À MEMBRANE

Lockable handwheel for diaphragm valve

DIMENSIONS Dimensions			RÉFÉRENCE Product code
d mm	DN mm	G inch	
20	15	1/2"	2150-04AA
25	20	3/4"	2150-04AA
32	25	1"	2150-04AA
40	32	1"1/4	2150-04AA
50	40	1"1/2	2150-04AA
63	50	2"	2150-05AA

Pour commander un robinet avec volant cadenassable, rajouter la référence à la fin du robinet. Par exemple 2100-05FFE + 2150-05AA.

To order a diaphragm valve with a lockable handwheel, add the code at the end of the code of the valve. For example 2100-05FFE + 2150-05AA.

OPTIONS & ACCESSOIRES

Options & accessories

OPTIONS



N° Fiche produit - Product sheet
TDS-BUTT-3600

AXE POUR ROBINET PAPILLON

Shaft for butterfly valve

DIMENSIONS		RÉFÉRENCE		
Dimensions		Product code		
d	DN	Axe	Axe	Axe
mm	mm	INOX 316 SS316 shaft	INOX 316L SS316L shaft	HASTELLOY C Hastelloy C shaft
63	50	3701-050	3700L050	3700H050
75	65	3701-060	3700L060	3700H060
90	80	3701-070	3700L070	3700H070
110	100	3701-080	3700L080	3700H080
140	125	3701-090	3700L090	3700H090
160	150	3701-100	3700L100	3700H100
225	200	3701-110	3700L110	3700H110
280	250	3701-120	3700L120	3700H120
315	300	3701-130	3700L130	3700H130
355	350	3701-140	3700L140	3700H140
400	400	3701-150	3700L150	3700H150
450	450	3701-160	3700L160	3700H160
500	500	3701-170	3700L170	3700H170
630	600	3701-180	3700L180	3700H180
710	700	3700-190	3700L190	3700H190
800	800	3700-200	3700L200	3700H200
900	900	3700-210	3700L210	3700H210
1000	1000	3700-220	3700L220	3700H220

* Nous consulter.

* Consult us.

INSERTS LUG EN INOX 316 AVEC FILETTAGE AU PAS MÉTRIQUE POUR ROBINET PAPILLON

LUG inserts in SS316 metric female threaded for butterfly valve

DIMENSIONS		RÉFÉRENCE	NB D'INSERTS	RÉFÉRENCE	NB D'INSERTS
Dimensions		(BRIDES DIN*) Product code (DIN flanges*)	Qty of inserts	(BRIDES ANSI*) Product code (ANSI flanges*)	Qty of inserts
d	DN				
mm	mm				
63	50	2025-19A	4 x M16	2025-19A	4 x M16
75	65	2025-19B	4 x M16	2025-19B	4 x M16
90	80	2025-19C	8 x M16	2025-21A	4 x M16
110	100	2025-19D	8 x M16	2025-19D	8 x M16
140	125	2025-19E	8 x M16	2025-19E	8 x M16
160	150	2025-19F	8 x M20	2025-19F	8 x M20
225	200	2025-19G	8 x M20	2025-19G	8 x M20
280	250	2025-19H	12 x M20	2025-19H	12 x M20

* DIN = EN1092-1 PN10/16

Pas UNC : nous consulter.

UNC thread : please contact us.

ANSI = ASME B16.5 Class 150

L'entretien de nos robinets doit se faire suivant nos procédures disponibles sur demande.

The maintenance of our valves must be carried out following our procedures, which are available on demand.

OPTIONS & ACCESSOIRES

Options & accessories

OPTIONS



N° Fiche produit - Product sheet
TDS-BUTT-3600

KIT D'ENTRETIEN POUR ROBINET PAPILLON (MANCHETTE ET JOINTS)

Maintenance kit for butterfly valve (gasket and o-rings)

DIMENSIONS		RÉFÉRENCE	
Dimensions		Product code	
d	DN	EPDM	FPM
mm	mm		
63	50	3700-05EP	3700-05VT
75	65	3700-06EP	3700-06VT
90	80	3700-07EP	3700-07VT
110	100	3700-08EP	3700-08VT
140	125	3700-09EP	3700-09VT
160	150	3700-10EP	3700-10VT
225	200	3700-11EP	3700-11VT
280	250	3700-12EP	3700-12VT
315	300	3700-13EP	3700-13VT
355	350	3700-14EP	3700-14VT
400	400	3700-15EP	3700-15VT
450	450	3700-16EP	3700-16VT
500	500	3700-17EP	3700-17VT
630	600	3700-18EP	3700-18VT

L'entretien de nos robinets doit se faire suivant nos procédures disponibles sur demande.

The maintenance of our valves must be carried out following our procedures, which are available on demand.

CADENASSAGE POUR COMMANDE DE ROBINET À PAPILLON SÉRIES 3600 (PVC-U), 3610 (PVC-C), 3700 (PP-H), 3800 (PVDF)

Lockable handle for butterfly valve series 3600 (PVC-U), 3610 (PVC-C), 3700 (PP-H), 3800 (PVDF)

DIMENSIONS			RÉFÉRENCE
Dimensions			Product code
d	DN	G	
mm	mm	inch	
63	50	2"	6349
75	65	2"1/2	6349
90	80	3"	6349
110	100	4"	6349
125	125	5"	6380
160	150	6"	6380
225	200	8"	6381
280	250	10"	6317

- Pour commander un robinet avec poignée cadénassable, rajouter la référence à la fin du robinet. Par exemple 3700-10WWE + 6380.

To order a butterfly valve with a lockable handle, add the code at the end of the code of the valve. For example 3700-10WWE + 6380.

- Pour le DN250 qui est équipé d'un réducteur à volant, le cadénassage est réalisé par une plaque métallique (voir fiche produit).

For the DN250 which is equipped with a handwheel and reduction gearbox, the locking is made through a metal plate (see product sheet).

OPTIONS & ACCESSOIRES
Options & accessories

SERIE 2090



N° Fiche produit - Product sheet
TDS-SHIELD-2090

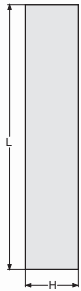

ENVELOPPE DE PROTECTION POUR ROBINET À BRIDE DIN/ANSI/BS*
Safety shields for DIN/ANSI/BS* flanged valve

DIMENSIONS Dimensions				RÉFÉRENCE Product code					
DN mm	G inch	L mm	H mm	PVC mixte/mixed	PVC Rouge/red	PE Marron/brown	PP Noir/black	PTFE Beige/beige	PTFE mixte/mixed
15	1/2"	390	140						
20	3/4"	440	150	2090-00PVC	2090-00PVC	2090-00PE	2090-00PP	2090-00PTFE	2090-00PTFT
25	1"	460	160	2090-01PVC	2090-01PVC	2090-01PE	2090-01PP	2090-01PTFE	2090-01PTFT
32	1 1/4"	540	180	2090-02PVC	2090-02PVC	2090-02PE	2090-02PP	2090-02PTFE	2090-02PTFT
40	1 1/2"	570	180	2090-03PVC	2090-03PVC	2090-03PE	2090-03PP	2090-03PTFE	2090-03PTFT
50	2"	630	190	2090-04PVC	2090-04PVC	2090-04PE	2090-04PP	2090-04PTFE	2090-04PTFT
65	2 1/2"	690	200	2090-05PVC	2090-05PVC	2090-05PE	2090-05PP	2090-05PTFE	2090-05PTFT
80	3"	730	200	2090-06PVC	2090-06PVC	2090-06PE	2090-06PP	2090-06PTFE	2090-06PTFT
100	4"	800	200	2090-07PVC	2090-07PVC	2090-07PE	2090-07PP	2090-07PTFE	2090-07PTFT
125	5"	900	210	2090-08PVC	2090-08PVC	2090-08PE	2090-08PP	2090-08PTFE	2090-08PTFT
150	6"	1020	220	2090-09PVC	2090-09PVC	2090-09PE	2090-09PP	2090-09PTFE	2090-09PTFT
200	8"	1150	230	2090-10PVC	2090-10PVC	2090-10PE	2090-10PP	2090-10PTFE	2090-10PTFT
250	10"	1350	240	2090-11PVC	2090-11PVC	2090-11PE	2090-11PP	2090-11PTFE	2090-11PTFT
300	12"	1530	240	2090-12PVC	2090-12PVC	2090-12PE	2090-12PP	2090-12PTFE	2090-12PTFT
				2090-13PVC	2090-13PVC	2090-13PE	2090-13PP	2090-13PTFE	2090-13PTFT

* DIN = EN1092-1 PN10/16

ANSI = ASME B16.5 Class 150

BS = BS10 table D

Enveloppes sur mesure : nous consulter.
Taylor made safety shields: please contact us.

quotes@tipes.co.uk

Options

OPTIONS & ACCESSOIRES

Options & accessories

SERIE 2021



N° Fiche produit - Product sheet
TDS-SEAL-2021

JOINT PLAT "PLEINS TROUS" POUR BRIDE EN1092-1 PN10 ("DIN")

Flat gasket for EN1092-1 PN10 ("DIN") flange

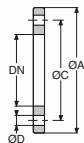

DIMENSIONS Dimensions					RÉFÉRENCE Product code	
DN	G	ØA	ØC	N x ØD	EPDM (5 mm)	FPM (3 mm)
mm	inch	mm	mm	mm		
15	1/2"	95	65	4 x 14	2021-00E	2021-00Z
20	3/4"	105	75	4 x 14	2021-01E	2021-01Z
25	1"	115	85	4 x 14	2021-02E	2021-02Z
32	1"1/4	140	100	4 x 18	2021-03E	2021-03Z
40	1"1/2	150	110	4 x 18	2021-04E	2021-04Z
50	2"	165	125	4 x 18	2021-05E	2021-05Z
65	2"1/2	185	145	4 x 18	2021-06E	2021-06Z
80	3"	200	160	8 x 18	2021-07E	2021-07Z
100	4"	220	180	8 x 18	2021-08E	2021-08Z
125	5"	250	210	8 x 18	2021-09E	2021-09Z
150	6"	285	240	8 x 22	2021-10E	2021-10Z

JOINT PLAT "PLEINS TROUS" POUR BRIDE ASME B16.5 CLASS 150 ("ANSI")

Flat gasket for ASME B16.5 Class 150 ("ANSI") flange

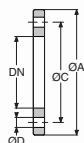

DIMENSIONS Dimensions					RÉFÉRENCE Product code	
DN	G	ØA	ØC	N x ØD	EPDM (5 mm)	FPM (3 mm)
mm	inch	mm	mm	mm		
15	1/2"	95	60.3	4 x 16	2021A00E	2021A00Z
20	3/4"	105	69.9	4 x 16	2021A01E	2021A01Z
25	1"	115	79.4	4 x 16	2021A02E	2021A02Z
32	1"1/4	140	88.9	4 x 16	2021A03E	2021A03Z
40	1"1/2	150	98.4	4 x 16	2021A04E	2021A04Z
50	2"	165	120.7	4 x 19	2021A05E	2021A05Z
65	2"1/2	185	139.7	4 x 19	2021A06E	2021A06Z
80	3"	200	152.4	4 x 19	2021A07E	2021A07Z
100	4"	220	190.5	8 x 19	2021A08E	2021A08Z
125	5"	250	215.9	8 x 19	2021A09E	2021A09Z
150	6"	285	241.3	8 x 22	2021A10E	2021A10Z

quotes@tfpes.co.uk

Tel: 01626 201092

123

www.safi-valves.com

FLOW CONTROL

Tel: 01626 201092



www.safi-valves.com



CONTRÔLE DES FLUIDES - Flow control

CONTRÔLE DES FLUIDES - Flow Control

Notre gamme « Contrôle des fluides » couvre tous les produits permettant de contrôler la nature, la pression et le débit du fluide :

- . Regard de coulée
- . Débitmètre à flotteur
- . Réducteur de pression
- . Détendeur de pression
- . Soupape de décharge
- . Séparateur à membrane pour manomètre

Our range «Flow Control» covers all products which control the nature, pressure and flowrate of the fluid:

- . Sight glass valve
- . Flow meter
- . Pressure reducer
- . Pressure retaining valve
- . Pressure relief valve
- . Diaphragm pressure gauge guard

REGARD DE COULÉE

Sight glass

SERIE 2030



N° Fiche produit - Product sheet
TDS-SIGHT-2030

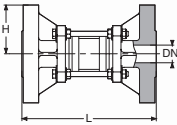

REGARD DE COULÉE EN PPGF À BRIDES

Flanged PPGF sight glass

DIMENSIONS					RÉFÉRENCE (BRIDES DIN*)		RÉFÉRENCE (BRIDES ANSI*)		PN
Dimensions					Product code (DIN flanges*)		Product code (ANSI flanges*)		
d	DN	G	L	H	EPDM	FPM	EPDM	FPM	bar
20	15	1/2"	130	47.5	2030-00FFE	2030-00FFV	2030-00GGE	2030-00GGV	10
25	20	3/4"	150	52.5	2030-01FFE	2030-01FFV	2030-01GGE	2030-01GGV	10

* DIN = EN1092-1 PN10/16

ANSI = ASME B16.5 Class 150



N° Fiche produit - Product sheet
TDS-SIGHT-2030A

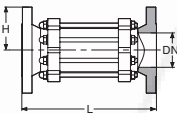

REGARD DE COULÉE EN PP-H À BRIDES

Flanged PP-H sight glass

DIMENSIONS					RÉFÉRENCE (BRIDES DIN*)		RÉFÉRENCE (BRIDES ANSI*)		PN
Dimensions					Product code (DIN flanges*)		Product code (ANSI flanges*)		
d	DN	G	L	H	EPDM	FPM	EPDM	FPM	bar
32	25	1"	160	57.5	2030-02FFE	2030-02FFV	2030-02GGE	2030-02GGV	10
40	32	1"1/4	180	70	2030-03FFE	2030-03FFV	2030-03GGE	2030-03GGV	10
50	40	1"1/2	200	75	2030-04FFE	2030-04FFV	2030-04GGE	2030-04GGV	10
63	50	2"	230	82.5	2030-05FFE	2030-05FFV	2030-05GGE	2030-05GGV	10
75	65	2"1/2	290	92.5	2030-06FFE	2030-06FFV	2030-06GGE	2030-06GGV	10
90	80	3"	310	100	2030-07FFE	2030-07FFV	2030-07GGE	2030-07GGV	7
110	100	4"	350	110	2030-08FFE	2030-08FFV	2030-08GGE	2030-08GGV	6
125	125	5"	400	125	2030-09FFE	2030-09FFV	2030-09GGE	2030-09GGV	5

* DIN = EN1092-1 PN10/16

ANSI = ASME B16.5 Class 150



N° Fiche produit - Product sheet
TDS-SIGHT-2030A

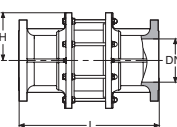

REGARD DE COULÉE EN PPGF À BRIDES DIN/ANSI

Flanged PPGF sight glass, with DIN/ANSI flanges

DIMENSIONS					RÉFÉRENCE (BRIDES DIN/ANSI*)		PN
Dimensions					Product code (DIN/ANSI flanges*)		
d	DN	G	L	H	EPDM	FPM	bar
160	150	6"	480	160	2030-10FFE	2030-10FFV	5

* DIN = EN1092-1 PN10/16

ANSI = ASME B16.5 Class 150

quotes@tipes.co.uk

Flow control

REGARD DE COULÉE
Sight glass

SERIE 2043



N° Fiche produit - Product sheet
TDS-SIGHT-2030/2030A

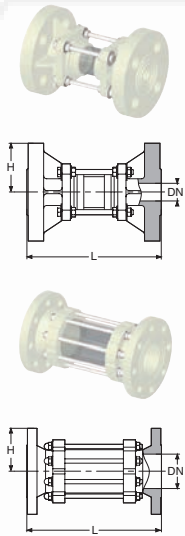

REGARD DE COULÉE EN PVDF À BRIDES
Flanged PVDF sight glass

DIMENSIONS Dimensions					RÉFÉRENCE (BRIDES DIN*) Product code (DIN flanges*)		RÉFÉRENCE (BRIDES ANSI*) Product code (ANSI flanges*)		PN bar
d mm	DN mm	G inch	L mm	H mm	EPDM	FPM	EPDM	FPM	
20	15	1/2"	130	47.5	2043-00FFE	2043-00FFZ	2043-00GGE	2043-00GGZ	10
25	20	3/4"	150	52.5	2043-01FFE	2043-01FFZ	2043-01GGE	2043-01GGZ	10
32	25	1"	160	57.5	2043-02FFE	2043-02FFZ	2043-02GGE	2043-02GGZ	10
40	32	1"1/4	180	70	2043-03FFE	2043-03FFZ	2043-03GGE	2043-03GGZ	10
50	40	1"1/2	200	75	2043-04FFE	2043-04FFZ	2043-04GGE	2043-04GGZ	10
63	50	2"	230	82.5	2043-05FFE	2043-05FFZ	2043-05GGE	2043-05GGZ	10
75	65	2"1/2	290	92.5	2043-06FFE	2043-06FFZ	2043-06GGE	2043-06GGZ	10
90	80	3"	310	100	2043-07FFE	2043-07FFZ	2043-07GGE	2043-07GGZ	7
110	100	4"	350	110	2043-08FFE	2043-08FFZ	2043-08GGE	2043-08GGZ	6

* DIN = EN1092-1 PN10/16

ANSI = ASME B16.5 Class 150



N° Fiche produit - Product sheet
TDS-SIGHT-2030A

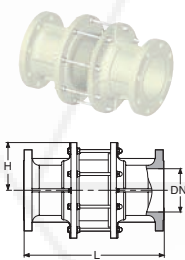

REGARD DE COULÉE EN PVDF À BRIDES DIN/ANSI
Flanged PVDF sight glass, with DIN/ANSI flanges

DIMENSIONS Dimensions					RÉFÉRENCE (BRIDES DIN/ANSI*) Product code (DIN/ANSI flanges*)		PN bar
d mm	DN mm	G inch	L mm	H mm	EPDM	FPM	
160	150	6"	480	155	2043-10FFE	2043-10FFZ	5

* DIN = EN1092-1 PN10/16

ANSI = ASME B16.5 Class 150

quotes@tffes.co.uk

Flow control

DÉBITMÈTRE Flow meter

SERIE M335



N° Fiche produit - Product sheet
TDS-FLOWM-M335

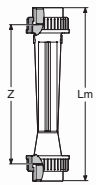

DÉBITMÈTRE À FLOTTEUR TYPE M335, TUBE PA AVEC GRADUATION POUR H₂O, ÉTANCHÉITÉ EPDM, DOUBLE UNION, EMBOUTS PVC-U FEMELLES

Flow meter type M335, tube in PA with scale for H₂O, EPDM sealing, double union, PVC-U metric sockets

DIMENSIONS Dimensions						RÉFÉRENCE Product code		
d	DN	G	z	Lm	Plage de mesure Measurement range L/h	Flotteur PVDF Float PVDF	Flotteur PVDF/aimant Float PVDF/magnet	PN bar
mm	mm	inch	mm	mm				
32	25	1"	341	385	50 - 500	M335PA-25-S-09-BBE	M335PA-25-A-09-BBE	10
32	25	1"	341	385	100 - 1000	M335PA-25-S-10-BBE	M335PA-25-A-10-BBE	10
40	32	1"1/4	341	393	150 - 1500	M335PA-32-S-11-BBE	M335PA-32-A-11-BBE	10
40	32	1"1/4	341	393	250 - 2500	M335PA-32-S-13-BBE	M335PA-32-A-13-BBE	10
50	40	1"1/2	341	403	200 - 2000	M335PA-40-S-12-BBE	M335PA-40-A-12-BBE	10
50	40	1"1/2	341	403	300 - 3000	M335PA-40-S-14-BBE	M335PA-40-A-14-BBE	10
50	40	1"1/2	341	403	600 - 6000	M335PA-40-S-15-BBE	M335PA-40-A-15-BBE	10
63	50	2"	341	417	600 - 6000	M335PA-50-S-15-BBE	M335PA-50-A-15-BBE	10
63	50	2"	341	417	1000 - 10000	M335PA-50-S-16-BBE	M335PA-50-A-16-BBE	10
63	50	2"	341	417	1500 - 15000	M335PA-50-S-18-BBE	M335PA-50-A-18-BBE	10
75	65	2"1/2	341	429	2000 - 20000	M335PA-65-S-19-BBE	M335PA-65-A-19-BBE	10
75	65	2"1/2	341	429	3000 - 30000	M335PA-65-S-20-BBE	M335PA-65-A-20-BBE	10
75	65	2"1/2	341	429	8000 - 60000	M335PA-65-S-21-BBE	M335PA-65-A-21-BBE	10

Autres échelles, nous consulter avec les informations suivantes :

- Fluide
- Densité
- Viscosité en cP ou mPas
- Température du fluide en °C
- Plage de mesure demandée en L/h.

For other scales, please consult us with the following information:

- Medium
- Density
- Viscosity in cP or mPas
- Operating temperature in °C
- Desired measuring range in L/h.

DÉBITMÈTRE Flow meter

SERIE M335



N° Fiche produit - Product sheet
TDS-FLOWM-M335

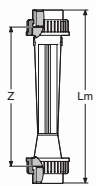

DÉBITMÈTRE À FLOTTEUR TYPE M335, TUBE PSU AVEC GRADUATION POUR H₂O, ÉTANCHÉITÉ EPDM, DOUBLE UNION, EMBOUTS PVC-U FEMELLES

Flow meter type M335, tube in PSU with scale for H₂O, EPDM sealing, double union, PVC-U metric sockets

DIMENSIONS Dimensions						RÉFÉRENCE Product code		
d	DN	G	z	Lm	Plage de mesure Measurement range L/h	Flotteur PVDF Float PVDF	Flotteur PVDF/aimant Float PVDF/magnet	PN bar
32	25	1"	341	385	50 - 500	M335PSU-25-S-09-BBE	M335PSU-25-A-09-BBE	10
32	25	1"	341	385	100 - 1000	M335PSU-25-S-10-BBE	M335PSU-25-A-10-BBE	10
40	32	1"1/4	341	393	150 - 1500	M335PSU-32-S-11-BBE	M335PSU-32-A-11-BBE	10
40	32	1"1/4	341	393	250 - 2500	M335PSU-32-S-13-BBE	M335PSU-32-A-13-BBE	10
50	40	1"1/2	341	403	200 - 2000	M335PSU-40-S-12-BBE	M335PSU-40-A-12-BBE	10
50	40	1"1/2	341	403	300 - 3000	M335PSU-40-S-14-BBE	M335PSU-40-A-14-BBE	10
50	40	1"1/2	341	403	600 - 6000	M335PSU-40-S-15-BBE	M335PSU-40-A-15-BBE	10
63	50	2"	341	417	600 - 6000	M335PSU-50-S-15-BBE	M335PSU-50-A-15-BBE	10
63	50	2"	341	417	1000 - 10000	M335PSU-50-S-16-BBE	M335PSU-50-A-16-BBE	10
63	50	2"	341	417	1500 - 15000	M335PSU-50-S-18-BBE	M335PSU-50-A-18-BBE	10
75	65	2"1/2	341	429	2000 - 20000	M335PSU-65-S-19-BBE	M335PSU-65-A-19-BBE	10
75	65	2"1/2	341	429	3000 - 30000	M335PSU-65-S-20-BBE	M335PSU-65-A-20-BBE	10
75	65	2"1/2	341	429	8000 - 60000	M335PSU-65-S-21-BBE	M335PSU-65-A-21-BBE	10

Autres échelles, nous consulter avec les informations suivantes :

- Fluide
- Densité
- Viscosité en cP ou mPas
- Température du fluide en °C
- Plage de mesure demandée en L/h.

For other scales, please consult us with the following information:

- Medium
- Density
- Viscosity in cP or mPas
- Operating temperature in °C
- Desired measuring range in L/h.

DÉBITMÈTRE Flow meter

SERIE M335



N° Fiche produit - Product sheet
TDS-FLOWM-M335

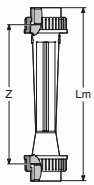

DÉBITMÈTRE À FLOTTEUR TYPE M335, TUBE PVC-U AVEC GRADUATION POUR H₂O, ÉTANCHÉITÉ EPDM, DOUBLE UNION, EMBOUTS PVC-U FEMELLES

Flow meter type M335, tube in PVC-U with scale for H₂O, EPDM sealing, double union, PVC-U metric sockets

DIMENSIONS Dimensions						RÉFÉRENCE Product code		
d	DN	G	z	Lm	Plage de mesure Measurement range L/h	Flotteur PVDF Float PVDF	Flotteur PVDF/aimant Float PVDF/magnet	PN bar
32	25	1"	341	385	50 - 500	M335PVC-25-S-09-BBE	M335PVC-25-A-09-BBE	10
32	25	1"	341	385	100 - 1000	M335PVC-25-S-10-BBE	M335PVC-25-A-10-BBE	10
40	32	1"1/4	341	393	150 - 1500	M335PVC-32-S-11-BBE	M335PVC-32-A-11-BBE	10
40	32	1"1/4	341	393	250 - 2500	M335PVC-32-S-13-BBE	M335PVC-32-A-13-BBE	10
50	40	1"1/2	341	403	200 - 2000	M335PVC-40-S-12-BBE	M335PVC-40-A-12-BBE	10
50	40	1"1/2	341	403	300 - 3000	M335PVC-40-S-14-BBE	M335PVC-40-A-14-BBE	10
50	40	1"1/2	341	403	600 - 6000	M335PVC-40-S-15-BBE	M335PVC-40-A-15-BBE	10
63	50	2"	341	417	600 - 6000	M335PVC-50-S-15-BBE	M335PVC-50-A-15-BBE	10
63	50	2"	341	417	1000 - 10000	M335PVC-50-S-16-BBE	M335PVC-50-A-16-BBE	10
63	50	2"	341	417	1500 - 15000	M335PVC-50-S-18-BBE	M335PVC-50-A-18-BBE	10
75	65	2"1/2	341	429	2000 - 20000	M335PVC-65-S-19-BBE	M335PVC-65-A-19-BBE	10
75	65	2"1/2	341	429	3000 - 30000	M335PVC-65-S-20-BBE	M335PVC-65-A-20-BBE	10
75	65	2"1/2	341	429	8000 - 60000	M335PVC-65-S-21-BBE	M335PVC-65-A-21-BBE	10

Autres échelles, nous consulter avec les informations suivantes :

- Fluide
- Densité
- Viscosité en cP ou mPas
- Température du fluide en °C
- Plage de mesure demandée en L/h.

For other scales, please consult us with the following information:

- Medium
- Density
- Viscosity in cP or mPas
- Operating temperature in °C
- Desired measuring range in L/h.

DÉBITMÈTRE
Flow meter

SERIE M350



N° Fiche produit - Product sheet
TDS-FLOWM-M335

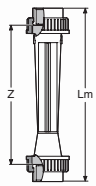

DÉBITMÈTRE À FLOTTEUR TYPE M350, TUBE PA AVEC GRADUATION POUR H₂O, ÉTANCHÉITÉ EPDM, DOUBLE UNION, EMBOUTS PVC-U FEMELLES

Flow meter type M350, tube in PA with scale for H₂O, EPDM sealing, double union, PVC-U metric sockets

DIMENSIONS Dimensions						RÉFÉRENCE Product code		
d	DN	G	z	Lm	Plage de mesure Measurement range L/h	Flotteur PVDF Float PVDF	Flotteur PVDF/aimant Float PVDF/magnet	PN bar
mm	mm	inch	mm	mm				
32	25	1"	356	400	50 - 500	M350PA-25-S-09-BBE	M350PA-25-A-09-BBE	10
32	25	1"	356	400	100 - 1000	M350PA-25-S-10-BBE	M350PA-25-A-10-BBE	10
40	32	1"1/4	356	408	150 - 1500	M350PA-32-S-11-BBE	M350PA-32-A-11-BBE	10
40	32	1"1/4	356	408	250 - 2500	M350PA-32-S-13-BBE	M350PA-32-A-13-BBE	10
50	40	1"1/2	356	418	200 - 2000	M350PA-40-S-12-BBE	M350PA-40-A-12-BBE	10
50	40	1"1/2	356	418	300 - 3000	M350PA-40-S-14-BBE	M350PA-40-A-14-BBE	10
50	40	1"1/2	356	418	600 - 6000	M350PA-40-S-15-BBE	M350PA-40-A-15-BBE	10
63	50	2"	356	432	600 - 6000	M350PA-50-S-15-BBE	M350PA-50-A-15-BBE	10
63	50	2"	356	432	1000 - 10000	M350PA-50-S-16-BBE	M350PA-50-A-16-BBE	10
63	50	2"	356	432	1500 - 15000	M350PA-50-S-18-BBE	M350PA-50-A-18-BBE	10
75	65	2"1/2	356	444	2000 - 20000	M350PA-65-S-19-BBE	M350PA-65-A-19-BBE	10
75	65	2"1/2	356	444	3000 - 30000	M350PA-65-S-20-BBE	M350PA-65-A-20-BBE	10
75	65	2"1/2	356	444	8000 - 60000	M350PA-65-S-21-BBE	M350PA-65-A-21-BBE	10

Autres échelles, nous consulter avec les informations suivantes :

- Fluide
- Densité
- Viscosité en cP ou mPas
- Température du fluide en °C
- Plage de mesure demandée en L/h.

For other scales, please consult us with the following information:

- Medium
- Density
- Viscosity in cP or mPas
- Operating temperature in °C
- Desired measuring range in L/h.

quotes@tfps.co.uk

Flow control

DÉBITMÈTRE

Flow meter

SERIE M350



N° Fiche produit - Product sheet
TDS-FLOWM-M335

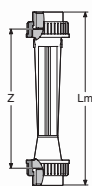

DÉBITMÈTRE À FLOTTEUR TYPE M350, TUBE PSU AVEC GRADUATION POUR H₂O, ÉTANCHÉITÉ EPDM, DOUBLE UNION, EMBOUTS PVC-U FEMELLES

Flow meter type M350, tube in PSU with scale for H₂O, EPDM sealing, double union, PVC-U metric sockets

DIMENSIONS Dimensions						RÉFÉRENCE Product code		
d	DN	G	z	Lm	Plage de mesure Measurement range L/h	Flotteur PVDF Float PVDF	Flotteur PVDF/aimant Float PVDF/magnet	PN bar
32	25	1"	356	400	50 - 500	M350PSU-25-S-09-BBE	M350PSU-25-A-09-BBE	10
32	25	1"	356	400	100 - 1000	M350PSU-25-S-10-BBE	M350PSU-25-A-10-BBE	10
40	32	1"1/4	356	408	150 - 1500	M350PSU-32-S-11-BBE	M350PSU-32-A-11-BBE	10
40	32	1"1/4	356	408	250 - 2500	M350PSU-32-S-13-BBE	M350PSU-32-A-13-BBE	10
50	40	1"1/2	356	418	200 - 2000	M350PSU-40-S-12-BBE	M350PSU-40-A-12-BBE	10
50	40	1"1/2	356	418	300 - 3000	M350PSU-40-S-14-BBE	M350PSU-40-A-14-BBE	10
50	40	1"1/2	356	418	600 - 6000	M350PSU-40-S-15-BBE	M350PSU-40-A-15-BBE	10
63	50	2"	356	432	600 - 6000	M350PSU-50-S-15-BBE	M350PSU-50-A-15-BBE	10
63	50	2"	356	432	1000 - 10000	M350PSU-50-S-16-BBE	M350PSU-50-A-16-BBE	10
63	50	2"	356	432	1500 - 15000	M350PSU-50-S-18-BBE	M350PSU-50-A-18-BBE	10
75	65	2"1/2	356	444	2000 - 20000	M350PSU-65-S-19-BBE	M350PSU-65-A-19-BBE	10
75	65	2"1/2	356	444	3000 - 30000	M350PSU-65-S-20-BBE	M350PSU-65-A-20-BBE	10
75	65	2"1/2	356	444	8000 - 60000	M350PSU-65-S-21-BBE	M350PSU-65-A-21-BBE	10

Autres échelles, nous consulter avec les informations suivantes :

- Fluide
- Densité
- Viscosité en cP ou mPas
- Température du fluide en °C
- Plage de mesure demandée en L/h.

For other scales, please consult us with the following information:

- Medium
- Density
- Viscosity in cP or mPas
- Operating temperature in °C
- Desired measuring range in L/h.

DÉBITMÈTRE
Flow meter

SERIE M350



N° Fiche produit - Product sheet
TDS-FLOWM-M335

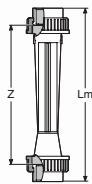

DÉBITMÈTRE À FLOTTEUR TYPE M350, TUBE PVC-U AVEC GRADUATION POUR H₂O, ÉTANCHÉITÉ EPDM, DOUBLE UNION, EMBOUTS PVC-U FEMELLES

Flow meter type M350, tube in PVC-U with scale for H₂O, EPDM sealing, double union, PVC-U metric sockets

DIMENSIONS Dimensions						RÉFÉRENCE Product code		
d	DN	G	z	Lm	Plage de mesure Measurement range L/h	Flotteur PVDF Float PVDF	Flotteur PVDF/aimant Float PVDF/magnet	PN bar
32	25	1"	356	400	50 - 500	M350PVC-25-S-09-BBE	M350PVC-25-A-09-BBE	10
32	25	1"	356	400	100 - 1000	M350PVC-25-S-10-BBE	M350PVC-25-A-10-BBE	10
40	32	1"1/4	356	408	150 - 1500	M350PVC-32-S-11-BBE	M350PVC-32-A-11-BBE	10
40	32	1"1/4	356	408	250 - 2500	M350PVC-32-S-13-BBE	M350PVC-32-A-13-BBE	10
50	40	1"1/2	356	418	200 - 2000	M350PVC-40-S-12-BBE	M350PVC-40-A-12-BBE	10
50	40	1"1/2	356	418	300 - 3000	M350PVC-40-S-14-BBE	M350PVC-40-A-14-BBE	10
50	40	1"1/2	356	418	600 - 6000	M350PVC-40-S-15-BBE	M350PVC-40-A-15-BBE	10
63	50	2"	356	432	600 - 6000	M350PVC-50-S-15-BBE	M350PVC-50-A-15-BBE	10
63	50	2"	356	432	1000 - 10000	M350PVC-50-S-16-BBE	M350PVC-50-A-16-BBE	10
63	50	2"	356	432	1500 - 15000	M350PVC-50-S-18-BBE	M350PVC-50-A-18-BBE	10
75	65	2"1/2	356	444	2000 - 20000	M350PVC-65-S-19-BBE	M350PVC-65-A-19-BBE	10
75	65	2"1/2	356	444	3000 - 30000	M350PVC-65-S-20-BBE	M350PVC-65-A-20-BBE	10
75	65	2"1/2	356	444	8000 - 60000	M350PVC-65-S-21-BBE	M350PVC-65-A-21-BBE	10

Autres échelles, nous consulter avec les informations suivantes :

- Fluide
- Densité
- Viscosité en cP ou mPas
- Température du fluide en °C
- Plage de mesure demandée en L/h.

For other scales, please consult us with the following information:

- Medium
- Density
- Viscosity in cP or mPas
- Operating temperature in °C
- Desired measuring range in L/h.

quotes@tfps.co.uk

Flow control

DÉBITMÈTRE Flow meter

SERIE M123



N° Fiche produit - Product sheet
TDS-FLOWM-M123

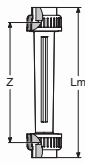

DÉBITMÈTRE À FLOTTEUR TYPE M123, TUBE PSU AVEC GRADUATION POUR H₂O, ÉTANCHÉITÉ EPDM, DOUBLE UNION, EMBOUTS PVC-U FEMELLES

Flow meter type M123, tube in PSU with scale for H₂O, EPDM sealing, double union, PVC-U metric sockets

DIMENSIONS Dimensions						RÉFÉRENCE Product code		
d	DN	G	z	Lm	Plage de mesure Measurement range L/h	Flotteur PVDF Float PVDF	Flotteur PVDF/aimant Float PVDF/magnet	PN bar
16	10	3/8"	171	199	1.5 - 15	M123PSU-10-S-01-BBE	M123PSU-10-A-01-BBE	10
16	10	3/8"	171	199	2.5 - 25	M123PSU-10-S-02-BBE	M123PSU-10-A-02-BBE	10
16	10	3/8"	171	199	5 - 50	M123PSU-10-S-03-BBE	M123PSU-10-A-03-BBE	10
16	10	3/8"	171	199	10 - 100	M123PSU-10-S-05-BBE	M123PSU-10-A-05-BBE	10
20	15	1/2"	191	223	8 - 80	M123PSU-15-S-04-BBE	M123PSU-15-A-04-BBE	10
20	15	1/2"	191	223	15 - 150	M123PSU-15-S-06-BBE	M123PSU-15-A-06-BBE	10
20	15	1/2"	191	223	20 - 200	M123PSU-15-S-07-BBE	M123PSU-15-A-07-BBE	10
32	25	1"	206	250	15 - 150	M123PSU-25-S-06-BBE	M123PSU-25-A-06-BBE	10
32	25	1"	206	250	30 - 300	M123PSU-25-S-08-BBE	M123PSU-25-A-08-BBE	10
32	25	1"	206	250	50 - 500	M123PSU-25-S-09-BBE	M123PSU-25-A-09-BBE	10
32	25	1"	206	250	100 - 1000	M123PSU-25-S-10-BBE	M123PSU-25-A-10-BBE	10

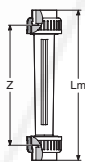

DÉBITMÈTRE À FLOTTEUR TYPE M123, TUBE PVC-U AVEC GRADUATION POUR H₂O, ÉTANCHÉITÉ EPDM, DOUBLE UNION, EMBOUTS PVC-U FEMELLES

Flow meter type M123, tube in PVC-U with scale for H₂O, EPDM sealing, double union, PVC-U metric sockets

DIMENSIONS Dimensions						RÉFÉRENCE Product code		
d	DN	G	z	Lm	Plage de mesure Measurement range L/h	Flotteur PVDF Float PVDF	Flotteur PVDF/aimant Float PVDF/magnet	PN bar
16	10	3/8"	171	199	1.5 - 15	M123PVC-10-S-01-BBE	M123PVC-10-A-01-BBE	10
16	10	3/8"	171	199	2.5 - 25	M123PVC-10-S-02-BBE	M123PVC-10-A-02-BBE	10
16	10	3/8"	171	199	5 - 50	M123PVC-10-S-03-BBE	M123PVC-10-A-03-BBE	10
16	10	3/8"	171	199	10 - 100	M123PVC-10-S-05-BBE	M123PVC-10-A-05-BBE	10
20	15	1/2"	191	223	8 - 80	M123PVC-15-S-04-BBE	M123PVC-15-A-04-BBE	10
20	15	1/2"	191	223	15 - 150	M123PVC-15-S-06-BBE	M123PVC-15-A-06-BBE	10
20	15	1/2"	191	223	20 - 200	M123PVC-15-S-07-BBE	M123PVC-15-A-07-BBE	10
32	25	1"	206	250	15 - 150	M123PVC-25-S-06-BBE	M123PVC-25-A-06-BBE	10
32	25	1"	206	250	30 - 300	M123PVC-25-S-08-BBE	M123PVC-25-A-08-BBE	10
32	25	1"	206	250	50 - 500	M123PVC-25-S-09-BBE	M123PVC-25-A-09-BBE	10
32	25	1"	206	250	100 - 1000	M123PVC-25-S-10-BBE	M123PVC-25-A-10-BBE	10

Autres échelles, nous consulter avec les informations suivantes :

- Fluide
- Densité
- Viscosité en cP ou mPas
- Température du fluide en °C
- Plage de mesure demandée en L/h.

For other scales, please consult us with the following information:

- Medium
- Density
- Viscosity in cP or mPas
- Operating temperature in °C
- Desired measuring range in L/h.

DÉBITMÈTRE
Flow meter

OPTIONS



N° Fiche produit - Product sheet
TDS-FLOWM-M123



CAPTEUR DE FIN DE COURSE POUR DÉBITMÈTRE M335 / M350 / M123
Limit switch for flowmeter M335 / M350 / M123

TYPE Type	RÉFÉRENCE Product code
Z 40 min	LS-Z40min
Z 42 max	LS-Z42max



CAPTEUR DE MESURE 4-20 MA TYPE Z60 POUR DÉBITMÈTRE M335 / M350
4-20 mA Measured Value Sensor Z60 for flowmeter M335 / M350

PLAGE DE MESURE Measurement range L/h	RÉFÉRENCE Product code
50 - 500	MVS-Z60-17100926
100 - 1000	MVS-Z60-17100927
150 - 1500	MVS-Z60-17100928
250 - 2500	MVS-Z60-17100929
200 - 2000	MVS-Z60-17100930
300 - 3000	MVS-Z60-17100931
600 - 6000 (DN40)	MVS-Z60-17100932
600 - 6000 (DN50)	MVS-Z60-17100933
1000 - 10000	MVS-Z60-17100934
1500 - 15000	MVS-Z60-17100935
2000 - 20000	MVS-Z60-17100936
3000 - 30000	MVS-Z60-17100937
8000 - 60000	MVS-Z60-17100938

quotes@tfpes.co.uk

Flow control

RÉDUCTEUR DE PRESSION

Pressure reducer

SERIE V182-V82



N° Fiche produit - Product sheet
TDS-REDUC-V82

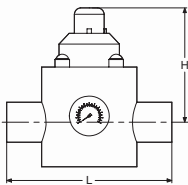

RÉDUCTEUR DE PRESSION EN PVC-U, SORTIES PVC-U MÂLES

Pressure reducer in PVC-U, PVC-U metric spigot outlets

DIMENSIONS Dimensions						RÉFÉRENCE Product code		
d	DN	G	H	L	Plage de réglage Adjustment range bar	Membrane EPDM EPDM diaphragm	Membrane FPM FPM diaphragm	PN bar
15	10	3/8"	112	134	0.5 - 9	V182PVC-10ZZE	V182PVC-10ZZV	10
20	15	1/2"	112	134	0.5 - 9	V182PVC-15ZZE	V182PVC-15ZZV	10
25	20	3/4"	130	174	0.5 - 9	V182PVC-20ZZE	V182PVC-20ZZV	10
32	25	1"	130	174	0.5 - 9	V182PVC-25ZZE	V182PVC-25ZZV	10
40	32	1"1/4	175	224	0.5 - 9	V182PVC-32ZZE	V182PVC-32ZZV	10
50	40	1"1/2	175	224	0.5 - 9	V182PVC-40ZZE	V182PVC-40ZZV	10
63	50	2"	210	244	0.5 - 9	V182PVC-50ZZE	V182PVC-50ZZV	10

DIMENSIONS Dimensions						RÉFÉRENCE Product code		
d	DN	G	H	L	Plage de réglage Adjustment range bar	Membrane EPDM EPDM diaphragm	Membrane PTFE PTFE diaphragm	PN bar
75	65	2"1/2	250	300	0.5 - 5	V82PVC-65ZZE	V82PVC-65ZZP	6
90	80	3"	305	360	0.5 - 5	V82PVC-80ZZE	V82PVC-80ZZP	6
110	100	4"	345	420	1 - 3	V82PVC-100ZZE	V82PVC-100ZZP	4

RÉDUCTEUR DE PRESSION EN PVC-U, À BRIDES DIN*

Pressure reducer in PVC-U, with DIN* flanges

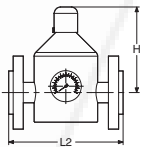

DIMENSIONS Dimensions						RÉFÉRENCE Product code		
d	DN	G	H	L2	Plage de réglage Adjustment range bar	Membrane EPDM EPDM diaphragm	Membrane FPM FPM diaphragm	PN bar
15	10	3/8"	112	140	0.5 - 9	V182PVC-10FFE	V182PVC-10FFV	10
20	15	1/2"	112	140	0.5 - 9	V182PVC-15FFE	V182PVC-15FFV	10
25	20	3/4"	130	180	0.5 - 9	V182PVC-20FFE	V182PVC-20FFV	10
32	25	1"	130	180	0.5 - 9	V182PVC-25FFE	V182PVC-25FFV	10
40	32	1"1/4	175	230	0.5 - 9	V182PVC-32FFE	V182PVC-32FFV	10
50	40	1"1/2	175	230	0.5 - 9	V182PVC-40FFE	V182PVC-40FFV	10
63	50	2"	210	250	0.5 - 9	V182PVC-50FFE	V182PVC-50FFV	10

DIMENSIONS Dimensions						RÉFÉRENCE Product code		
d	DN	G	H	L2	Plage de réglage Adjustment range bar	Membrane EPDM EPDM diaphragm	Membrane PTFE PTFE diaphragm	PN bar
75	65	2"1/2	250	306	0.5 - 5	V82PVC-65FFE	V82PVC-65FFP	6
90	80	3"	305	370	0.5 - 5	V82PVC-80FFE	V82PVC-80FFP	6
110	100	4"	345	430	1 - 3	V82PVC-100FFE	V82PVC-100FFP	4

* DIN = EN1092-1 PN10/16

RÉDUCTEUR DE PRESSION

Pressure reducer

SERIE V182-V82



N° Fiche produit - Product sheet
TDS-REDUC-V82

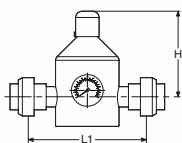

RÉDUCTEUR DE PRESSION EN PVC-U, DOUBLE UNION, EMBOUTS PVC-U FEMELLES MÉTRIQUES

Pressure reducer in PVC-U, double union, PVC-U metric sockets

DIMENSIONS Dimensions						RÉFÉRENCE Product code		
d	DN	G	H	L1	Plage de réglage Adjustment range bar	Membrane EPDM EPDM diaphragm	Membrane FPM FPM diaphragm	PN bar
15	10	3/8"	112	154	0.5 - 9	V182PVC-10BBE	V182PVC-10BBV	10
20	15	1/2"	112	154	0.5 - 9	V182PVC-15BBE	V182PVC-15BBV	10
25	20	3/4"	130	185	0.5 - 9	V182PVC-20BBE	V182PVC-20BBV	10
32	25	1"	130	185	0.5 - 9	V182PVC-25BBE	V182PVC-25BBV	10
40	32	1"1/4	175	248	0.5 - 9	V182PVC-32BBE	V182PVC-32BBV	10
50	40	1"1/2	175	252	0.5 - 9	V182PVC-40BBE	V182PVC-40BBV	10
63	50	2"	210	280	0.5 - 9	V182PVC-50BBE	V182PVC-50BBV	10

quotes@tfpes.co.uk

Flow control

RÉDUCTEUR DE PRESSION

Pressure reducer

SERIE V182-V82



N° Fiche produit - Product sheet
TDS-REDUC-V82



RÉDUCTEUR DE PRESSION EN PP-H, SORTIES PP-H MÂLES

Pressure reducer in PP-H, PP-H metric spigot outlets

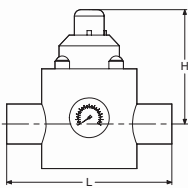

DIMENSIONS Dimensions						RÉFÉRENCE Product code		
d	DN	G	H	L	Plage de réglage Adjustment range bar	Membrane EPDM EPDM diaphragm	Membrane FPM FPM diaphragm	PN bar
15	10	3/8"	112	134	0.5 - 9	V182PPH-10ZZE	V182PPH-10ZZV	10
20	15	1/2"	112	134	0.5 - 9	V182PPH-15ZZE	V182PPH-15ZZV	10
25	20	3/4"	130	174	0.5 - 9	V182PPH-20ZZE	V182PPH-20ZZV	10
32	25	1"	130	174	0.5 - 9	V182PPH-25ZZE	V182PPH-25ZZV	10
40	32	1"1/4	175	224	0.5 - 9	V182PPH-32ZZE	V182PPH-32ZZV	10
50	40	1"1/2	175	224	0.5 - 9	V182PPH-40ZZE	V182PPH-40ZZV	10
63	50	2"	210	244	0.5 - 9	V182PPH-50ZZE	V182PPH-50ZZV	10

DIMENSIONS Dimensions						RÉFÉRENCE Product code		
d	DN	G	H	L	Plage de réglage Adjustment range bar	Membrane EPDM EPDM diaphragm	Membrane PTFE PTFE diaphragm	PN bar
75	65	2"1/2	250	300	0.5 - 5	V82PPH-65ZZE	V82PPH-65ZZP	6
90	80	3"	305	360	0.5 - 5	V82PPH-80ZZE	V82PPH-80ZZP	6
110	100	4"	345	420	1 - 3	V82PPH-100ZZE	V82PPH-100ZZP	4

RÉDUCTEUR DE PRESSION EN PP-H, À BRIDES DIN*

Pressure reducer in PP-H, with DIN* flanges

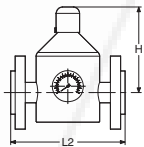

DIMENSIONS Dimensions						RÉFÉRENCE Product code		
d	DN	G	H	L2	Plage de réglage Adjustment range bar	Membrane EPDM EPDM diaphragm	Membrane FPM FPM diaphragm	PN bar
15	10	3/8"	112	140	0.5 - 9	V182PPH-10FFE	V182PPH-10FFV	10
20	15	1/2"	112	140	0.5 - 9	V182PPH-15FFE	V182PPH-15FFV	10
25	20	3/4"	130	180	0.5 - 9	V182PPH-20FFE	V182PPH-20FFV	10
32	25	1"	130	180	0.5 - 9	V182PPH-25FFE	V182PPH-25FFV	10
40	32	1"1/4	175	230	0.5 - 9	V182PPH-32FFE	V182PPH-32FFV	10
50	40	1"1/2	175	230	0.5 - 9	V182PPH-40FFE	V182PPH-40FFV	10
63	50	2"	210	250	0.5 - 9	V182PPH-50FFE	V182PPH-50FFV	10

DIMENSIONS Dimensions						RÉFÉRENCE Product code		
d	DN	G	H	L2	Plage de réglage Adjustment range bar	Membrane EPDM EPDM diaphragm	Membrane PTFE PTFE diaphragm	PN bar
75	65	2"1/2	250	306	0.5 - 5	V82PPH-65FFE	V82PPH-65FFP	6
90	80	3"	305	370	0.5 - 5	V82PPH-80FFE	V82PPH-80FFP	6
110	100	4"	345	430	1 - 3	V82PPH-100FFE	V82PPH-100FFP	4

* DIN = EN1092-1 PN10/16

RÉDUCTEUR DE PRESSION

Pressure reducer

SERIE V182-V82



N° Fiche produit - Product sheet
TDS-REDUC-V82

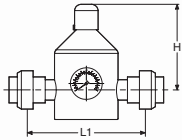

RÉDUCTEUR DE PRESSION EN PP-H, DOUBLE UNION, EMBOUTS PP-H FEMELLES MÉTRIQUES

Pressure reducer in PP-H, double union, PP-H metric sockets

DIMENSIONS Dimensions						RÉFÉRENCE Product code		
d	DN	G	H	L1	Plage de réglage Adjustment range bar	Membrane EPDM EPDM diaphragm	Membrane FPM FPM diaphragm	PN bar
15	10	3/8"	112	154	0.5 - 9	V182PPH-10CCE	V182PPH-10CCV	10
20	15	1/2"	112	154	0.5 - 9	V182PPH-15CCE	V182PPH-15CCV	10
25	20	3/4"	130	185	0.5 - 9	V182PPH-20CCE	V182PPH-20CCV	10
32	25	1"	130	185	0.5 - 9	V182PPH-25CCE	V182PPH-25CCV	10
40	32	1"1/4	175	248	0.5 - 9	V182PPH-32CCE	V182PPH-32CCV	10
50	40	1"1/2	175	252	0.5 - 9	V182PPH-40CCE	V182PPH-40CCV	10
63	50	2"	210	280	0.5 - 9	V182PPH-50CCE	V182PPH-50CCV	10

quotes@tfpes.co.uk

RÉDUCTEUR DE PRESSION

Pressure reducer

SERIE V182-V82



N° Fiche produit - Product sheet
TDS-REDUC-V82

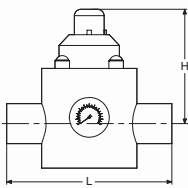

RÉDUCTEUR DE PRESSION EN PVDF, SORTIES PVDF MÂLES

Pressure reducer in PVDF, PVDF metric spigot outlets

DIMENSIONS Dimensions						RÉFÉRENCE Product code	
d	DN	G	H	L	Plage de réglage Adjustment range	Membrane FPM FPM diaphragm	PN bar
mm	mm	inch	mm	mm	bar		
15	10	3/8"	112	134	0.5 - 9	V182PVDF-10ZZV	10
20	15	1/2"	112	134	0.5 - 9	V182PVDF-15ZZV	10
25	20	3/4"	130	174	0.5 - 9	V182PVDF-20ZZV	10
32	25	1"	130	174	0.5 - 9	V182PVDF-25ZZV	10
40	32	1"1/4	175	224	0.5 - 9	V182PVDF-32ZZV	10
50	40	1"1/2	175	224	0.5 - 9	V182PVDF-40ZZV	10
63	50	2"	210	244	0.5 - 9	V182PVDF-50ZZV	10

DIMENSIONS Dimensions						RÉFÉRENCE Product code	
d	DN	G	H	L	Plage de réglage Adjustment range	Membrane PTFE PTFE diaphragm	PN bar
mm	mm	inch	mm	mm	bar		
75	65	2"1/2	250	300	0.5 - 5	V82PVDF-65ZZP	6

RÉDUCTEUR DE PRESSION EN PVDF, À BRIDES DIN*

Pressure reducer in PVDF, with DIN* flanges

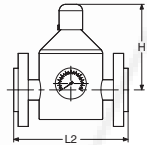

DIMENSIONS Dimensions						RÉFÉRENCE Product code	
d	DN	G	H	L2	Plage de réglage Adjustment range	Membrane FPM FPM diaphragm	PN bar
mm	mm	inch	mm	mm	bar		
15	10	3/8"	112	140	0.5 - 9	V182PVDF-10FFV	10
20	15	1/2"	112	140	0.5 - 9	V182PVDF-15FFV	10
25	20	3/4"	130	180	0.5 - 9	V182PVDF-20FFV	10
32	25	1"	130	180	0.5 - 9	V182PVDF-25FFV	10
40	32	1"1/4	175	230	0.5 - 9	V182PVDF-32FFV	10
50	40	1"1/2	175	230	0.5 - 9	V182PVDF-40FFV	10
63	50	2"	210	250	0.5 - 9	V182PVDF-50FFV	10

DIMENSIONS Dimensions						RÉFÉRENCE Product code	
d	DN	G	H	L2	Plage de réglage Adjustment range	Membrane PTFE PTFE diaphragm	PN bar
mm	mm	inch	mm	mm	bar		
75	65	2"1/2	250	306	0.5 - 5	V82PVDF-65FFP	6

* DIN = EN1092-1 PN10/16

RÉDUCTEUR DE PRESSION

Pressure reducer

SERIE V182-V82



N° Fiche produit - Product sheet
TDS-REDUC-V82

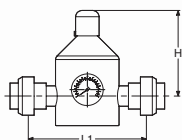

RÉDUCTEUR DE PRESSION EN PVDF, DOUBLE UNION, EMBOUTS PVDF FEMELLES MÉTRIQUES

Pressure reducer in PVDF, double union, PVDF metric sockets

DIMENSIONS Dimensions						RÉFÉRENCE Product code	
d	DN	G	H	L1	Plage de réglage Adjustment range bar	Membrane FPM FPM diaphragm	PN bar
15	10	3/8"	112	154	0.5 - 9	V182PVDF-10CCV	10
20	15	1/2"	112	154	0.5 - 9	V182PVDF-15CCV	10
25	20	3/4"	130	185	0.5 - 9	V182PVDF-20CCV	10
32	25	1"	130	185	0.5 - 9	V182PVDF-25CCV	10
40	32	1"1/4	175	248	0.5 - 9	V182PVDF-32CCV	10
50	40	1"1/2	175	252	0.5 - 9	V182PVDF-40CCV	10
63	50	2"	210	280	0.5 - 9	V182PVDF-50CCV	10

quotes@tfpes.co.uk

DÉTENDEUR DE PRESSION

Pressure retaining valve

SERIE V186-V86



N° Fiche produit - Product sheet
TDS-RETAIN-V86

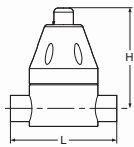

DÉTENDEUR DE PRESSION EN PVC-U, SORTIES PVC-U MÂLES

Pressure retaining valve in PVC-U, PVC-U metric spigot outlets

DIMENSIONS Dimensions						RÉFÉRENCE Product code		
d	DN	G	H	L	Plage de réglage Adjustment range bar	Membrane EPDM EPDM diaphragm	Membrane PTFE PTFE diaphragm	PN bar
15	10	3/8"	137	134	0.5 - 10	V186PVC-10ZZE	V186PVC-10ZZP	10
20	15	1/2"	137	134	0.5 - 10	V186PVC-15ZZE	V186PVC-15ZZP	10
25	20	3/4"	137	174	0.5 - 10	V186PVC-20ZZE	V186PVC-20ZZP	10
32	25	1"	199	174	0.5 - 10	V186PVC-25ZZE	V186PVC-25ZZP	10
40	32	1"1/4	199	224	0.5 - 10	V186PVC-32ZZE	V186PVC-32ZZP	10
50	40	1"1/2	290	224	0.5 - 10	V186PVC-40ZZE	V186PVC-40ZZP	10
63	50	2"	290	244	0.5 - 10	V186PVC-50ZZE	V186PVC-50ZZP	10

DIMENSIONS Dimensions						RÉFÉRENCE Product code		
d	DN	G	H	L	Plage de réglage Adjustment range bar	Membrane EPDM EPDM diaphragm	Membrane PTFE PTFE diaphragm	PN bar
75	65	2"1/2	275	284	1 - 6	V86PVC-65ZZE	V86PVC-65ZZP	6
90	80	3"	410	360	1 - 6	V86PVC-80ZZE	V86PVC-80ZZP	6
110	100	4"	485	380	1 - 4	V86PVC-100ZZE	V86PVC-100ZZP	4

DÉTENDEUR DE PRESSION EN PVC-U, À BRIDES DIN*

Pressure retaining valve in PVC-U, with DIN* flanges

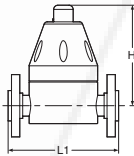

DIMENSIONS Dimensions						RÉFÉRENCE Product code		
d	DN	G	H	L1	Plage de réglage Adjustment range bar	Membrane EPDM EPDM diaphragm	Membrane PTFE PTFE diaphragm	PN bar
15	10	3/8"	137	140	0.5 - 10	V186PVC-10FFE	V186PVC-10FFP	10
20	15	1/2"	137	140	0.5 - 10	V186PVC-15FFE	V186PVC-15FFP	10
25	20	3/4"	137	180	0.5 - 10	V186PVC-20FFE	V186PVC-20FFP	10
32	25	1"	199	180	0.5 - 10	V186PVC-25FFE	V186PVC-25FFP	10
40	32	1"1/4	199	230	0.5 - 10	V186PVC-32FFE	V186PVC-32FFP	10
50	40	1"1/2	290	230	0.5 - 10	V186PVC-40FFE	V186PVC-40FFP	10
63	50	2"	290	250	0.5 - 10	V186PVC-50FFE	V186PVC-50FFP	10

DIMENSIONS Dimensions						RÉFÉRENCE Product code		
d	DN	G	H	L1	Plage de réglage Adjustment range bar	Membrane EPDM EPDM diaphragm	Membrane PTFE PTFE diaphragm	PN bar
75	65	2"1/2	275	290	1 - 6	V86PVC-65FFE	V86PVC-65FFP	6
90	80	3"	410	370	1 - 6	V86PVC-80FFE	V86PVC-80FFP	6
110	100	4"	485	390	1 - 4	V86PVC-100FFE	V86PVC-100FFP	4

* DIN = EN1092-1 PN10/16

DÉTENDEUR DE PRESSION

Pressure retaining valve

SERIE V186-V86



N° Fiche produit - Product sheet
TDS-RETAIN-V86

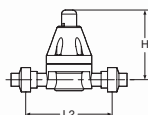

DÉTENDEUR DE PRESSION EN PVC-U, DOUBLE UNION, EMBOUTS PVC-U FEMELLES MÉTRIQUES

Pressure retaining valve in PVC-U, double union, PVC-U metric sockets

DIMENSIONS Dimensions						RÉFÉRENCE Product code		
d	DN	G	H	L2	Plage de réglage Adjustment range bar	Membrane EPDM EPDM diaphragm	Membrane PTFE PTFE diaphragm	PN bar
15	10	3/8"	137	154	0.5 - 10	V186PVC-10BBE	V186PVC-10BBP	10
20	15	1/2"	137	154	0.5 - 10	V186PVC-15BBE	V186PVC-15BBP	10
25	20	3/4"	137	154	0.5 - 10	V186PVC-20BBE	V186PVC-20BBP	10
32	25	1"	199	194	0.5 - 10	V186PVC-25BBE	V186PVC-25BBP	10
40	32	1"1/4	199	198	0.5 - 10	V186PVC-32BBE	V186PVC-32BBP	10
50	40	1"1/2	290	252	0.5 - 10	V186PVC-40BBE	V186PVC-40BBP	10
63	50	2"	290	280	0.5 - 10	V186PVC-50BBE	V186PVC-50BBP	10

quotes@tfpes.co.uk

DÉTENDEUR DE PRESSION

Pressure retaining valve

SERIE V186-V86



N° Fiche produit - Product sheet
TDS-RETAIN-V86

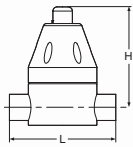

DÉTENDEUR DE PRESSION EN PP-H, SORTIES PP-H MÂLES

Pressure retaining valve in PP-H, PP-H metric spigot outlets

DIMENSIONS Dimensions						RÉFÉRENCE Product code		
d	DN	G	H	L	Plage de réglage Adjustment range bar	Membrane EPDM EPDM diaphragm	Membrane PTFE PTFE diaphragm	PN bar
15	10	3/8"	137	158	0.5 - 10	V186PPH-10ZZE	V186PPH-10ZZP	10
20	15	1/2"	137	158	0.5 - 10	V186PPH-15ZZE	V186PPH-15ZZP	10
25	20	3/4"	137	158	0.5 - 10	V186PPH-20ZZE	V186PPH-20ZZP	10
32	25	1"	199	198	0.5 - 10	V186PPH-25ZZE	V186PPH-25ZZP	10
40	32	1"1/4	199	202	0.5 - 10	V186PPH-32ZZE	V186PPH-32ZZP	10
50	40	1"1/2	290	256	0.5 - 10	V186PPH-40ZZE	V186PPH-40ZZP	10
63	50	2"	290	256	0.5 - 10	V186PPH-50ZZE	V186PPH-50ZZP	10

DIMENSIONS Dimensions						RÉFÉRENCE Product code		
d	DN	G	H	L	Plage de réglage Adjustment range bar	Membrane EPDM EPDM diaphragm	Membrane PTFE PTFE diaphragm	PN bar
75	65	2"1/2	275	284	1 - 6	V86PPH-65ZZE	V86PPH-65ZZP	6
90	80	3"	410	360	1 - 6	V86PPH-80ZZE	V86PPH-80ZZP	6
110	100	4"	485	380	1 - 4	V86PPH-100ZZE	V86PPH-100ZZP	4

DÉTENDEUR DE PRESSION EN PP-H, À BRIDES DIN*

Pressure retaining valve in PP-H, with DIN* flanges

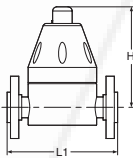

DIMENSIONS Dimensions						RÉFÉRENCE Product code		
d	DN	G	H	L1	Plage de réglage Adjustment range bar	Membrane EPDM EPDM diaphragm	Membrane PTFE PTFE diaphragm	PN bar
15	10	3/8"	137	168	0.5 - 10	V186PPH-10FFE	V186PPH-10FFP	10
20	15	1/2"	137	168	0.5 - 10	V186PPH-15FFE	V186PPH-15FFP	10
25	20	3/4"	137	168	0.5 - 10	V186PPH-20FFE	V186PPH-20FFP	10
32	25	1"	199	208	0.5 - 10	V186PPH-25FFE	V186PPH-25FFP	10
40	32	1"1/4	199	212	0.5 - 10	V186PPH-32FFE	V186PPH-32FFP	10
50	40	1"1/2	290	266	0.5 - 10	V186PPH-40FFE	V186PPH-40FFP	10
63	50	2"	290	266	0.5 - 10	V186PPH-50FFE	V186PPH-50FFP	10

DIMENSIONS Dimensions						RÉFÉRENCE Product code		
d	DN	G	H	L1	Plage de réglage Adjustment range bar	Membrane EPDM EPDM diaphragm	Membrane PTFE PTFE diaphragm	PN bar
75	65	2"1/2	275	294	1 - 6	V86PPH-65FFE	V86PPH-65FFP	6
90	80	3"	410	374	1 - 6	V86PPH-80FFE	V86PPH-80FFP	6
110	100	4"	485	394	1 - 4	V86PPH-100FFE	V86PPH-100FFP	4

* DIN = EN1092-1 PN10/16

DÉTENDEUR DE PRESSION

Pressure retaining valve

SERIE V186-V86



N° Fiche produit - Product sheet
TDS-RETAIN-V86

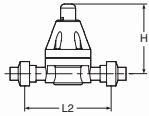

DÉTENDEUR DE PRESSION EN PP-H, DOUBLE UNION, EMBOUTS PP-H FEMELLES MÉTRIQUES

Pressure retaining valve in PP-H, double union, PP-H metric sockets

DIMENSIONS Dimensions						RÉFÉRENCE Product code		
d	DN	G	H	L2	Plage de réglage Adjustment range bar	Membrane EPDM EPDM diaphragm	Membrane PTFE PTFE diaphragm	PN bar
15	10	3/8"	137	180	0.5 - 10	V186PPH-10CCE	V186PPH-10CCP	10
20	15	1/2"	137	182	0.5 - 10	V186PPH-15CCE	V186PPH-15CCP	10
25	20	3/4"	137	182	0.5 - 10	V186PPH-20CCE	V186PPH-20CCP	10
32	25	1"	199	222	0.5 - 10	V186PPH-25CCE	V186PPH-25CCP	10
40	32	1"1/4	199	230	0.5 - 10	V186PPH-32CCE	V186PPH-32CCP	10
50	40	1"1/2	290	288	0.5 - 10	V186PPH-40CCE	V186PPH-40CCP	10
63	50	2"	290	296	0.5 - 10	V186PPH-50CCE	V186PPH-50CCP	10

quotes@tfpes.co.uk

DÉTENDEUR DE PRESSION

Pressure retaining valve

SERIE V186-V86



N° Fiche produit - Product sheet
TDS-RETAIN-V86

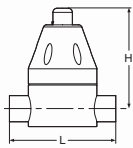

DÉTENDEUR DE PRESSION EN PVDF, SORTIES PVDF MÂLES

Pressure retaining valve in PVDF, PVDF metric spigot outlets

DIMENSIONS Dimensions						RÉFÉRENCE Product code	
d	DN	G	H	L	Plage de réglage Adjustment range bar	Membrane PTFE PTFE diaphragm	PN bar
15	10	3/8"	137	158	0.5 - 10	V186PVDF-10ZZP	10
20	15	1/2"	137	158	0.5 - 10	V186PVDF-15ZZP	10
25	20	3/4"	137	158	0.5 - 10	V186PVDF-20ZZP	10
32	25	1"	199	198	0.5 - 10	V186PVDF-25ZZP	10
40	32	1"1/4	199	202	0.5 - 10	V186PVDF-32ZZP	10
50	40	1"1/2	290	256	0.5 - 10	V186PVDF-40ZZP	10
63	50	2"	290	256	0.5 - 10	V186PVDF-50ZZP	10

DIMENSIONS Dimensions						RÉFÉRENCE Product code	
d	DN	G	H	L	Plage de réglage Adjustment range bar	Membrane PTFE PTFE diaphragm	PN bar
75	65	2"1/2	275	284	1 - 6	V86PVDF-65ZZP	6

DÉTENDEUR DE PRESSION EN PVDF, À BRIDES DIN*

Pressure retaining valve in PVDF, with DIN* flanges

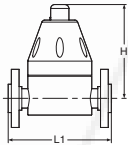

DIMENSIONS Dimensions						RÉFÉRENCE Product code	
d	DN	G	H	L2	Plage de réglage Adjustment range bar	Membrane PTFE PTFE diaphragm	PN bar
15	10	3/8"	137	168	0.5 - 10	V186PVDF-10FFP	10
20	15	1/2"	137	168	0.5 - 10	V186PVDF-15FFP	10
25	20	3/4"	137	168	0.5 - 10	V186PVDF-20FFP	10
32	25	1"	199	208	0.5 - 10	V186PVDF-25FFP	10
40	32	1"1/4	199	212	0.5 - 10	V186PVDF-32FFP	10
50	40	1"1/2	290	266	0.5 - 10	V186PVDF-40FFP	10
63	50	2"	290	266	0.5 - 10	V186PVDF-50FFP	10

* DIN = EN1092-1 PN10/16

DÉTENDEUR DE PRESSION

Pressure retaining valve

SERIE V186-V86



N° Fiche produit - Product sheet
TDS-RETAIN-V86

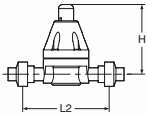

DÉTENDEUR DE PRESSION EN PVDF, DOUBLE UNION, EMBOUTS PVDF FEMELLES MÉTRIQUES

Pressure retaining valve in PVDF, double union, PVDF metric sockets

DIMENSIONS Dimensions						RÉFÉRENCE Product code	
d	DN	G	H	L2	Plage de réglage Adjustment range bar	Membrane PTFE PTFE diaphragm	PN bar
mm	mm	inch	mm	mm			
15	10	3/8"	137	180	0.5 - 10	V186PVDF-10CCP	10
20	15	1/2"	137	182	0.5 - 10	V186PVDF-15CCP	10
25	20	3/4"	137	182	0.5 - 10	V186PVDF-20CCP	10
32	25	1"	199	222	0.5 - 10	V186PVDF-25CCP	10
40	32	1"1/4	199	230	0.5 - 10	V186PVDF-32CCP	10
50	40	1"1/2	290	288	0.5 - 10	V186PVDF-40CCP	10
63	50	2"	290	296	0.5 - 10	V186PVDF-50CCP	10

quotes@tfpes.co.uk

SOUPAPE DE DÉCHARGE

Pressure relief valve

SERIE V185-V85



N° Fiche produit - Product sheet
TDS-RELIEF-V85

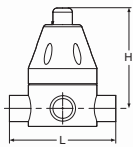

SOUPAPE DE DÉCHARGE EN PVC-U, SORTIES PVC-U MÂLES

Pressure relief valve in PVC-U, PVC-U metric spigot outlets

DIMENSIONS Dimensions						RÉFÉRENCE Product code		
d	DN	G	H	L	Plage de réglage Adjustment range bar	Membrane EPDM EPDM diaphragm	Membrane PTFE PTFE diaphragm	PN bar
15	10	3/8"	137	134	0.5 - 10	V185PVC-10ZZZE	V185PVC-10ZZZP	10
20	15	1/2"	137	134	0.5 - 10	V185PVC-15ZZZE	V185PVC-15ZZZP	10
25	20	3/4"	137	174	0.5 - 10	V185PVC-20ZZZE	V185PVC-20ZZZP	10
32	25	1"	199	174	0.5 - 10	V185PVC-25ZZZE	V185PVC-25ZZZP	10
40	32	1"1/4	199	224	0.5 - 10	V185PVC-32ZZZE	V185PVC-32ZZZP	10
50	40	1"1/2	290	224	0.5 - 10	V185PVC-40ZZZE	V185PVC-40ZZZP	10
63	50	2"	290	244	0.5 - 10	V185PVC-50ZZZE	V185PVC-50ZZZP	10

DIMENSIONS Dimensions						RÉFÉRENCE Product code		
d	DN	G	H	L	Plage de réglage Adjustment range bar	Membrane EPDM EPDM diaphragm	Membrane PTFE PTFE diaphragm	PN bar
75	65	2"1/2	275	284	1 - 6	V85PVC-65ZZZE	V85PVC-65ZZZP	6
90	80	3"	410	360	1 - 6	V85PVC-80ZZZE	V85PVC-80ZZZP	6
110	100	4"	485	380	1 - 4	V85PVC-100ZZZE	V85PVC-100ZZZP	4

SOUPAPE DE DÉCHARGE EN PVC-U, À BRIDES DIN*

Pressure relief valve in PVC-U, with DIN* flanges

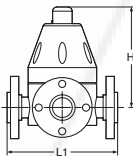

DIMENSIONS Dimensions						RÉFÉRENCE Product code		
d	DN	G	H	L1	Plage de réglage Adjustment range bar	Membrane EPDM EPDM diaphragm	Membrane PTFE PTFE diaphragm	PN bar
15	10	3/8"	137	140	0.5 - 10	V185PVC-10FFFE	V185PVC-10FFFP	10
20	15	1/2"	137	140	0.5 - 10	V185PVC-15FFFE	V185PVC-15FFFP	10
25	20	3/4"	137	180	0.5 - 10	V185PVC-20FFFE	V185PVC-20FFFP	10
32	25	1"	199	180	0.5 - 10	V185PVC-25FFFE	V185PVC-25FFFP	10
40	32	1"1/4	199	230	0.5 - 10	V185PVC-32FFFE	V185PVC-32FFFP	10
50	40	1"1/2	290	230	0.5 - 10	V185PVC-40FFFE	V185PVC-40FFFP	10
63	50	2"	290	250	0.5 - 10	V185PVC-50FFFE	V185PVC-50FFFP	10

DIMENSIONS Dimensions						RÉFÉRENCE Product code		
d	DN	G	H	L1	Plage de réglage Adjustment range bar	Membrane EPDM EPDM diaphragm	Membrane PTFE PTFE diaphragm	PN bar
75	65	2"1/2	275	290	1 - 6	V85PVC-65FFFE	V85PVC-65FFFP	6
90	80	3"	410	370	1 - 6	V85PVC-80FFFE	V85PVC-80FFFP	6
110	100	4"	485	390	1 - 4	V85PVC-100FFFE	V85PVC-100FFFP	4

* DIN = EN1092-1 PN10/16

SOUPAPE DE DÉCHARGE

Pressure relief valve

SERIE V185-V85



N° Fiche produit - Product sheet
TDS-RELIEF-V85

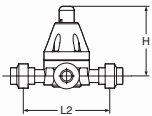

SOUPAPE DE DÉCHARGE EN PVC-U, DOUBLE UNION, EMBOUTS PVC-U FEMELLES MÉTRIQUES

Pressure relief valve in PVC-U, double union, PVC-U metric sockets

DIMENSIONS Dimensions						RÉFÉRENCE Product code		
d	DN	G	H	L2	Plage de réglage Adjustment range bar	Membrane EPDM EPDM diaphragm	Membrane PTFE PTFE diaphragm	PN bar
15	10	3/8"	137	154	0.5 - 10	V185PVC-10BBBE	V185PVC-10BBBP	10
20	15	1/2"	137	154	0.5 - 10	V185PVC-15BBBE	V185PVC-15BBBP	10
25	20	3/4"	137	154	0.5 - 10	V185PVC-20BBBE	V185PVC-20BBBP	10
32	25	1"	199	194	0.5 - 10	V185PVC-25BBBE	V185PVC-25BBBP	10
40	32	1"1/4	199	198	0.5 - 10	V185PVC-32BBBE	V185PVC-32BBBP	10
50	40	1"1/2	290	252	0.5 - 10	V185PVC-40BBBE	V185PVC-40BBBP	10
63	50	2"	290	280	0.5 - 10	V185PVC-50BBBE	V185PVC-50BBBP	10

quotes@tfpes.co.uk

SOUPAPE DE DÉCHARGE

Pressure relief valve

SERIE V185-V85



N° Fiche produit - Product sheet
TDS-RELIEF-V85

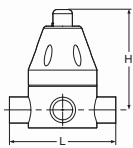

SOUPAPE DE DÉCHARGE EN PP-H, SORTIES PP-H MÂLES

Pressure retaining valve in PP-H, PP-H metric spigot outlets

DIMENSIONS Dimensions						RÉFÉRENCE Product code		
d	DN	G	H	L	Plage de réglage Adjustment range bar	Membrane EPDM EPDM diaphragm	Membrane PTFE PTFE diaphragm	PN bar
15	10	3/8"	137	158	0.5 - 10	V185PPH-10ZZZE	V185PPH-10ZZZP	10
20	15	1/2"	137	158	0.5 - 10	V185PPH-15ZZZE	V185PPH-15ZZZP	10
25	20	3/4"	137	158	0.5 - 10	V185PPH-20ZZZE	V185PPH-20ZZZP	10
32	25	1"	199	198	0.5 - 10	V185PPH-25ZZZE	V185PPH-25ZZZP	10
40	32	1"1/4	199	202	0.5 - 10	V185PPH-32ZZZE	V185PPH-32ZZZP	10
50	40	1"1/2	290	256	0.5 - 10	V185PPH-40ZZZE	V185PPH-40ZZZP	10
63	50	2"	290	256	0.5 - 10	V185PPH-50ZZZE	V185PPH-50ZZZP	10

DIMENSIONS Dimensions						RÉFÉRENCE Product code		
d	DN	G	H	L	Plage de réglage Adjustment range bar	Membrane EPDM EPDM diaphragm	Membrane PTFE PTFE diaphragm	PN bar
75	65	2"1/2	275	284	1 - 6	V85PPH-65ZZZE	V85PPH-65ZZZP	6
90	80	3"	410	360	1 - 6	V85PPH-80ZZZE	V85PPH-80ZZZP	6
110	100	4"	485	380	1 - 4	V85PPH-100ZZZE	V85PPH-100ZZZP	4

SOUPAPE DE DÉCHARGE EN PP-H, À BRIDES DIN*

Pressure relief valve in PP-H, with DIN* flanges

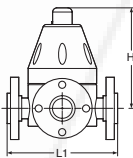

DIMENSIONS Dimensions						RÉFÉRENCE Product code		
d	DN	G	H	L1	Plage de réglage Adjustment range bar	Membrane EPDM EPDM diaphragm	Membrane PTFE PTFE diaphragm	PN bar
15	10	3/8"	137	168	0.5 - 10	V185PPH-10FFFE	V185PPH-10FFFP	10
20	15	1/2"	137	168	0.5 - 10	V185PPH-15FFFE	V185PPH-15FFFP	10
25	20	3/4"	137	168	0.5 - 10	V185PPH-20FFFE	V185PPH-20FFFP	10
32	25	1"	199	208	0.5 - 10	V185PPH-25FFFE	V185PPH-25FFFP	10
40	32	1"1/4	199	212	0.5 - 10	V185PPH-32FFFE	V185PPH-32FFFP	10
50	40	1"1/2	290	266	0.5 - 10	V185PPH-40FFFE	V185PPH-40FFFP	10
63	50	2"	290	266	0.5 - 10	V185PPH-50FFFE	V185PPH-50FFFP	10

DIMENSIONS Dimensions						RÉFÉRENCE Product code		
d	DN	G	H	L1	Plage de réglage Adjustment range bar	Membrane EPDM EPDM diaphragm	Membrane PTFE PTFE diaphragm	PN bar
75	65	2"1/2	275	294	1 - 6	V85PPH-65FFFE	V85PPH-65FFFP	6
90	80	3"	410	374	1 - 6	V85PPH-80FFFE	V85PPH-80FFFP	6
110	100	4"	485	394	1 - 4	V85PPH-100FFFE	V85PPH-100FFFP	4

* DIN = EN1092-1 PN10/16

SOUPAPE DE DÉCHARGE

Pressure relief valve

SERIE V185-V85



N° Fiche produit - Product sheet
TDS-RELIEF-V85

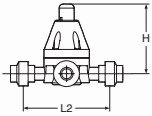

SOUPAPE DE DÉCHARGE EN PP-H, DOUBLE UNION, EMBOUTS PP-H FEMELLES MÉTRIQUES

Pressure relief valve in PP-H, double union, PP-H metric sockets

DIMENSIONS Dimensions						RÉFÉRENCE Product code		
d	DN	G	H	L2	Plage de réglage Adjustment range bar	Membrane EPDM EPDM diaphragm	Membrane PTFE PTFE diaphragm	PN bar
15	10	3/8"	137	180	0.5 - 10	V185PPH-10CCCE	V185PPH-10CCCP	10
20	15	1/2"	137	182	0.5 - 10	V185PPH-15CCCE	V185PPH-15CCCP	10
25	20	3/4"	137	182	0.5 - 10	V185PPH-20CCCE	V185PPH-20CCCP	10
32	25	1"	199	222	0.5 - 10	V185PPH-25CCCE	V185PPH-25CCCP	10
40	32	1"1/4	199	230	0.5 - 10	V185PPH-32CCCE	V185PPH-32CCCP	10
50	40	1"1/2	290	288	0.5 - 10	V185PPH-40CCCE	V185PPH-40CCCP	10
63	50	2"	290	296	0.5 - 10	V185PPH-50CCCE	V185PPH-50CCCP	10

quotes@tfpes.co.uk

SOUPAPE DE DÉCHARGE

Pressure relief valve

SERIE V185-V85



N° Fiche produit - Product sheet
TDS-RELIEF-V85

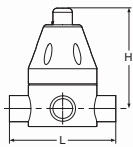

SOUPAPE DE DÉCHARGE EN PVDF, SORTIES PVDF MÂLES

Pressure relief valve in PVDF, PVDF metric spigot outlets

DIMENSIONS Dimensions						RÉFÉRENCE Product code	
d	DN	G	H	L	Plage de réglage Adjustment range bar	Membrane PTFE PTFE diaphragm	PN bar
15	10	3/8"	137	158	0.5 - 10	V185PVDF-10ZZZP	10
20	15	1/2"	137	158	0.5 - 10	V185PVDF-15ZZZP	10
25	20	3/4"	137	158	0.5 - 10	V185PVDF-20ZZZP	10
32	25	1"	199	198	0.5 - 10	V185PVDF-25ZZZP	10
40	32	1"1/4	199	202	0.5 - 10	V185PVDF-32ZZZP	10
50	40	1"1/2	290	256	0.5 - 10	V185PVDF-40ZZZP	10
63	50	2"	290	256	0.5 - 10	V185PVDF-50ZZZP	10
75	65	2"1/2	275	284	1 - 6	V85PVDF-65ZZZP	6

SOUPAPE DE DÉCHARGE EN PVDF, À BRIDES DIN*

Pressure relief valve in PVDF, with DIN* flanges

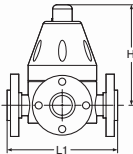

DIMENSIONS Dimensions						RÉFÉRENCE Product code	
d	DN	G	H	L1	Plage de réglage Adjustment range bar	Membrane PTFE PTFE diaphragm	PN bar
15	10	3/8"	137	168	0.5 - 10	V185PVDF-10FFFP	10
20	15	1/2"	137	168	0.5 - 10	V185PVDF-15FFFP	10
25	20	3/4"	137	168	0.5 - 10	V185PVDF-20FFFP	10
32	25	1"	199	208	0.5 - 10	V185PVDF-25FFFP	10
40	32	1"1/4	199	212	0.5 - 10	V185PVDF-32FFFP	10
50	40	1"1/2	290	266	0.5 - 10	V185PVDF-40FFFP	10
63	50	2"	290	266	0.5 - 10	V185PVDF-50FFFP	10

* DIN = EN1092-1 PN10/16

SOUPAPE DE DÉCHARGE EN PVDF, DOUBLE UNION, EMBOUTS PVDF FEMELLES MÉTRIQUES

Pressure relief valve in PVDF, double union, PVDF metric sockets

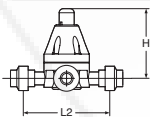

DIMENSIONS Dimensions						RÉFÉRENCE Product code	
d	DN	G	H	L2	Plage de réglage Adjustment range bar	Membrane PTFE PTFE diaphragm	PN bar
15	10	3/8"	137	180	0.5 - 10	V185PVDF-10CCCP	10
20	15	1/2"	137	182	0.5 - 10	V185PVDF-15CCCP	10
25	20	3/4"	137	182	0.5 - 10	V185PVDF-20CCCP	10
32	25	1"	199	222	0.5 - 10	V185PVDF-25CCCP	10
40	32	1"1/4	199	230	0.5 - 10	V185PVDF-32CCCP	10
50	40	1"1/2	290	288	0.5 - 10	V185PVDF-40CCCP	10
63	50	2"	290	296	0.5 - 10	V185PVDF-50CCCP	10

SÉPARATEUR À MEMBRANE

Diaphragm gauge guard

SERIE Z800



N° Fiche produit - Product sheet
TDS-GAUGE-Z800

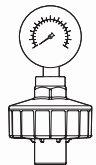

SÉPARATEUR À MEMBRANE POUR MANOMÈTRE, AVEC MANOMÈTRE STANDARD 0 - 10 BAR

Diaphragm pressure gauge guard, with standard manometer 0 - 10 bar

CONNEXION MANOMÈTRE Connection to manometer	CONNEXION FLUIDE Connection to fluid	RÉFÉRENCE Product code		
		PVC-U	PP-H	PVDF
Tarauté G 1/4"	Tarauté G 1/4"	Z800PVC1/4G1/4-10	Z800PPHG1/4G1/4-10	Z800PVDFG1/4G1/4-10
Tarauté G 1/4"	Tarauté G 1/2"	Z800PVC1/4G1/2-10	Z800PPHG1/4G1/2-10	Z800PVDFG1/4G1/2-10
Tarauté G 1/4"	Tarauté NPT 1/4"	Z800PVC1/4N1/4-10	Z800PPHG1/4N1/4-10	Z800PVDFG1/4N1/4-10
Tarauté G 1/4"	Tarauté NPT 1/2"	Z800PVC1/4N1/2-10	Z800PPHG1/4N1/2-10	Z800PVDFG1/4N1/2-10
Tarauté G 1/4"	Mâle d25	Z800PVC1/4d25-10	Z800PPHG1/4IRd25-10	Z800PVDFG1/4IRd25-10
Tarauté G 1/4"	Mâle d32	Z800PVC1/4d32-10	Z800PPHG1/4IRd32-10	Z800PVDFG1/4IRd32-10
Tarauté G 1/2"	Tarauté G 1/4"	Z800PVC1/2G1/4-10	Z800PPHG1/2G1/4-10	Z800PVDFG1/2G1/4-10
Tarauté G 1/2"	Tarauté G 1/2"	Z800PVC1/2G1/2-10	Z800PPHG1/2G1/2-10	Z800PVDFG1/2G1/2-10
Tarauté G 1/2"	Tarauté NPT 1/4"	Z800PVC1/2N1/4-10	Z800PPHG1/2N1/4-10	Z800PVDFG1/2N1/4-10
Tarauté G 1/2"	Tarauté NPT 1/2"	Z800PVC1/2N1/2-10	Z800PPHG1/2N1/2-10	Z800PVDFG1/2N1/2-10
Tarauté G 1/2"	Mâle d25	Z800PVC1/2d25-10	Z800PPHG1/2IRd25-10	Z800PVDFG1/2IRd25-10
Tarauté G 1/2"	Mâle d32	Z800PVC1/2d32-10	Z800PPHG1/2IRd32-10	Z800PVDFG1/2IRd32-10

SÉPARATEUR À MEMBRANE POUR MANOMÈTRE, AVEC MANOMÈTRE STANDARD 0 - 6 BAR

Diaphragm pressure gauge guard, with standard manometer 0 - 6 bar

CONNEXION MANOMÈTRE Connection to manometer	CONNEXION FLUIDE Connection to fluid	RÉFÉRENCE Product code		
		PVC-U	PP-H	PVDF
Tarauté G 1/4"	Tarauté G 1/4"	Z800PVC1/4G1/4-06	Z800PPHG1/4G1/4-06	Z800PVDFG1/4G1/4-06
Tarauté G 1/4"	Tarauté G 1/2"	Z800PVC1/4G1/2-06	Z800PPHG1/4G1/2-06	Z800PVDFG1/4G1/2-06
Tarauté G 1/4"	Tarauté NPT 1/4"	Z800PVC1/4N1/4-06	Z800PPHG1/4N1/4-06	Z800PVDFG1/4N1/4-06
Tarauté G 1/4"	Tarauté NPT 1/2"	Z800PVC1/4N1/2-06	Z800PPHG1/4N1/2-06	Z800PVDFG1/4N1/2-06
Tarauté G 1/4"	Mâle d25	Z800PVC1/4d25-06	Z800PPHG1/4IRd25-06	Z800PVDFG1/4IRd25-06
Tarauté G 1/4"	Mâle d32	Z800PVC1/4d32-06	Z800PPHG1/4IRd32-06	Z800PVDFG1/4IRd32-06
Tarauté G 1/2"	Tarauté G 1/4"	Z800PVC1/2G1/4-06	Z800PPHG1/2G1/4-06	Z800PVDFG1/2G1/4-06
Tarauté G 1/2"	Tarauté G 1/2"	Z800PVC1/2G1/2-06	Z800PPHG1/2G1/2-06	Z800PVDFG1/2G1/2-06
Tarauté G 1/2"	Tarauté NPT 1/4"	Z800PVC1/2N1/4-06	Z800PPHG1/2N1/4-06	Z800PVDFG1/2N1/4-06
Tarauté G 1/2"	Tarauté NPT 1/2"	Z800PVC1/2N1/2-06	Z800PPHG1/2N1/2-06	Z800PVDFG1/2N1/2-06
Tarauté G 1/2"	Mâle d25	Z800PVC1/2d25-06	Z800PPHG1/2IRd25-06	Z800PVDFG1/2IRd25-06
Tarauté G 1/2"	Mâle d32	Z800PVC1/2d32-06	Z800PPHG1/2IRd32-06	Z800PVDFG1/2IRd32-06

quotes@tfpes.co.uk

Flow control

IBC

Tel: 01626 201092



ROBINETS ET ACCESSOIRES DE CUVE – Valves and accessories for IBC

ROBINETS ET ACCESSOIRES DE CUVE – Valves and accessories for IBC

SAFI propose de nombreux robinets et accessoires pour les cuves et GRV destinés au stockage de produits chimiques.

Les pages suivantes présentent nos principaux produits standards. N'hésitez pas à nous contacter pour obtenir la liste complète des options et personnalisations proposées.

SAFI offers numerous valves and accessories for tanks and IBCs used to store chemicals.

The following pages present our main standard products. Do not hesitate to contact us for a complete list of options and customizations.

ROBINET À TOURNANT SPHÉRIQUE DE CUVE IBC ball valve

SERIE 2080



N° Fiche produit - Product sheet
TDS-BALL-2080

STANDARDS &
APPROVALS

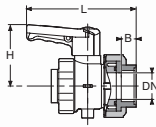

ROBINET DE CUVE PPGF À TOURNANT SPHÉRIQUE, CADENASSABLE, SORTIE TARAUDÉE PAS DU GAZ CYLINDRIQUE, SIMPLE UNION, EMBOUT PPGF TARAUDÉ PAS DU GAZ CYLINDRIQUE
IBC's PPGF ball valve, lockable, BSP threaded outlet, single union, PPGF BSP threaded socket

DIMENSIONS Dimensions						RÉFÉRENCE Product code	
d	DN	G	L	H	B	EPDM	FPM
mm	mm	inch	mm	mm	mm		
63	50	2"	154	110	26	2080-2A5R5E	2080-2A5R5V

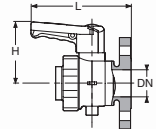

ROBINET DE CUVE PPGF À TOURNANT SPHÉRIQUE, CADENASSABLE, SORTIE TARAUDÉE PAS DU GAZ CYLINDRIQUE, À BRIDE DIN*
IBC's PPGF ball valve, lockable, BSP threaded outlet, DIN* flange

DIMENSIONS Dimensions					RÉFÉRENCE Product code	
d	DN	G	L	H	EPDM	FPM
mm	mm	inch	mm	mm		
63	50	2"	136	110	2080-5F5R5E	2080-5F5R5V

* DIN = EN 1092-1 PN10

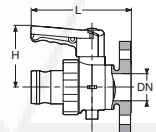

ROBINET DE CUVE PPGF À TOURNANT SPHÉRIQUE, CADENASSABLE, SORTIE CAMLOCK, À BRIDE DIN*
IBC's PPGF ball valve, lockable, camlock outlet, DIN* flange

DIMENSIONS Dimensions					RÉFÉRENCE Product code	
d	DN	G	L	H	EPDM	FPM
mm	mm	inch	mm	mm		
63	50	2"	172	110	2080-5F5Q5E	2080-5F5Q5V

* DIN = EN 1092-1 PN10

OPTIONS série 2080



Nombreuses connexions et options possibles, consultez notre fiche produit.
Many types of fittings and options available, please refer to the product sheet.

ROBINET À TOURNANT SPHÉRIQUE DE CUVE
IBC ball valve

SERIE 2047



N° Fiche produit - Product sheet
TDS-BALL-2047



ROBINET DE CUVE PE-HD À TOURNANT SPHÉRIQUE, SORTIE TARAUDÉE PAS DU GAZ CYLINDRIQUE, SIMPLE UNION, EMBOUT PPGF TARAUDÉ PAS DU GAZ

IBC's PE-HD ball valve, BSP threaded outlet, single union, PPGF BSP threaded socket

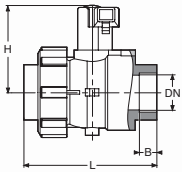

DIMENSIONS Dimensions						RÉFÉRENCE Product code	
d	DN	G	L	H	B	EPDM	FPM
mm	mm	inch	mm	mm	mm		
63	50	2"	183	118	26	2047-05AAE	2047-05AAV

SERIE 2050



N° Fiche produit - Product sheet
TDS-BALL-2047



ROBINET DE CUVE PE-HD À TOURNANT SPHÉRIQUE, SORTIE TARAUDÉE PAS DU GAZ CYLINDRIQUE, À BRIDE DIN*

IBC's PE-HD ball valve, BSP threaded outlet, DIN* flange

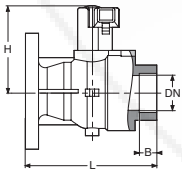

DIMENSIONS Dimensions						RÉFÉRENCE Product code	
d	DN	G	L	H	B	EPDM	FPM
mm	mm	inch	mm	mm	mm		
63	50	2"	183	121	26	2050-05FAE	2050-05FAV

* DIN = EN 1092-1 PN10

quotes@tfpes.co.uk

COUVERCLE DE CUVE Tank lid

SERIE 1002



N° Fiche produit - Product sheet
TDS-TANK-1002

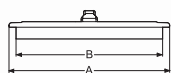

COUVERCLE DE CUVE Ø 400 EN PEBD AVEC COLLET ET VISSERIE PE-LD Manhole cover with collet, Ø 400, with screws

DIMENSIONS Dimensions		RÉFÉRENCE Product code
A	B	
mm	mm	
510	440	1002-14

Peut être équipé d'une soupape type 2005-01.
Can be equipped with a vent 2005-01.

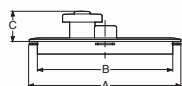

COUVERCLE DE CUVE Ø 270 EN PEBD AVEC SOUPAPE, COLLET ET VISSERIE PE-LD Manhole cover with collet and vent, Ø 270, with screws

DIMENSIONS Dimensions			RÉFÉRENCE Product code
A	B	C	
mm	mm	mm	EPDM
300	270	60	1002-03

SERIE MADIG



N° Fiche produit - Product sheet
TDS-TANK-MADIG

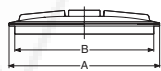

COUVERCLE DE CUVE EN PPGF AVEC COLLET PPGF Manhole cover with collet

DIMENSIONS Dimensions		RÉFÉRENCE Product code
A	B	
mm	mm	
355	320	MADIG0016
455	415	MADIG0015
620	575	MADIG0007

SOUPAPE D'AÉRATION

Tank vent

SERIE 2005



N° Fiche produit - Product sheet
TDS-TANK-2005

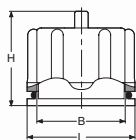

SOUPAPE D'AÉRATION EN PP-H DOUBLE EFFET

Anti splash double effect tank vent

DIMENSIONS			RÉFÉRENCE	
Dimensions			Product code	
L	H	B	EPDM	FPM
mm	mm	mm		
80	88	64	2005-01EP	2005-01VT

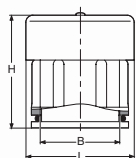

SOUPAPE D'AÉRATION EN PP-H À DÉPRESSION, CHAPEAU DE PROTECTION EN PE-HD JAUNE

Anti splash / vacuum breaker vent in PP-H, with a PE-HD yellow protection cap

DIMENSIONS			RÉFÉRENCE	
Dimensions			Product code	
L	H	B	EPDM	FPM
mm	mm	mm		
88	95	64	2005-01LDE	2005-01LDV

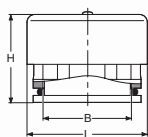

SOUPAPE D'AÉRATION EN PP-H À PRESSION, CHAPEAU DE PROTECTION EN PE-HD JAUNE

Anti pressure vent in PP-H, with a PE-HD yellow protection cap

DIMENSIONS			RÉFÉRENCE	
Dimensions			Product code	
L	H	B	EPDM	FPM
mm	mm	mm		
88	68.5	64	2005-01LPE	2005-01LPV

quotes@tfpes.co.uk

TRAVERSÉE DE CLOISON

Bulkhead fitting

SERIE 2002



N° Fiche produit - Product sheet
TDS-TANK-2002

STANDARDS &
APPROVALS



TRAVERSÉE DE CLOISON EN PPGF, CORPS FILETÉ PAS DU GAZ CYLINDRIQUE, FOURNIE AVEC JOINT PLAT, ÉCROU ET CONTRE-ÉCROU (SANS BOUCHON)

Bulkhead fitting in PPGF, BSP threaded body, supplied with gasket, locking nut and backing nut (without cap)

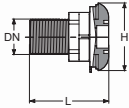

DIMENSIONS Dimensions				RÉFÉRENCE Product code	
DN mm	G inch	L mm	H mm	EPDM	FPM
15	1/2"	85.5	60	2002-00ADE	2002-00ADV
20	3/4"	85.5	68	2002-01ADE	2002-01ADV
25	1"	105.5	75	2002-02ADE	2002-02ADV
32	1"1/4	105.5	85	2002-03ADE	2002-03ADV
40	1"1/2	105.5	90	2002-04ADE	2002-04ADV
50	2"	105.5	105	2002-05ADE	2002-05ADV

TRAVERSÉE DE CLOISON EN PPGF POUR TUYAU SOUPLE, CORPS FILETÉ PAS DU GAZ CYLINDRIQUE, FOURNIE AVEC JOINT PLAT, ÉCROU ET CONTRE-ÉCROU

Bulkhead fitting in PPGF for hosetail, BSP threaded body, supplied with gasket, locking nut and backing nut

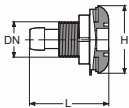

DIMENSIONS Dimensions				RÉFÉRENCE Product code	
DN mm	G inch	L mm	H mm	EPDM	FPM
15	1/2"	85.5	60	2002-00BDE	2002-00BDV
20	3/4"	85.5	68	2002-01BDE	2002-01BDV
25	1"	105.5	75	2002-02BDE	2002-02BDV
32	1"1/4	105.5	85	2002-03BDE	2002-03BDV
40	1"1/2	105.5	90	2002-04BDE	2002-04BDV
50	2"	105.5	105	2002-05BDE	2002-05BDV

BOUCHON EN PPGF, TARAUDÉ PAS DU GAZ CYLINDRIQUE, ÉQUIPÉ DE LIEN SANTOPRÈNE NOIR ET JOINT

PPGF cap, BSP female threaded, equipped with santoprene black link and o-ring

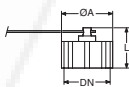

DIMENSIONS Dimensions				RÉFÉRENCE Product code	
DN mm	G inch	L mm	ØA mm	EPDM	FPM
15	1/2"	41	35	2002-00THE	2002-00THV
20	3/4"	37	41	2002-01THE	2002-01THV
25	1"	47.5	47.5	2002-02THE	2002-02THV
32	1"1/4	57.5	49.5	2002-03THE	2002-03THV
40	1"1/2	49	63	2002-04THE	2002-04THV
50	2"	52.5	76	2002-05THE	2002-05THV

quotes@tipes.co.uk

ACCESSOIRES DE CUVE
Accessories for IBC

SERIE 1009



N° Fiche produit - Product sheet
TDS-TANK-1009



ROBINET DE CUVE PP-H ORANGE
Tank orange tap in PP-H

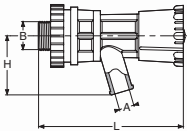

DIMENSIONS Dimensions					RÉFÉRENCE Product code	
A	B	L	H	nb tours nb of turns	EPDM	FPM
mm	inch	mm	mm			
10	3/8"	91	30	3/4 tour	1009-02EP	1009-02VT
10	1/2"	91	30	3/4 tour	1009-03EP	1009-03VT
10	3/4"	89	30	3/4 tour	1009-04EP	1009-04VT
15	3/4"	112	47	4 tours 1/2	1009-08EP	1009-08VT

SERIE 1005



N° Fiche produit - Product sheet
TDS-BALL-2080

STANDARDS &
APPROVALS



BOUCHON DE CUVE PPGF NOIR, FILETÉ PAS DU GAZ CYLINDRIQUE, AVEC LIEN SANTOPRÈNE NOIR
IBC's PPGF black cap, BSP male threaded, with santoprene black link

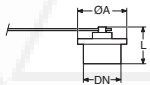

DIMENSIONS Dimensions					RÉFÉRENCE Product code	
d	DN	G	L	ØA	EPDM	FPM
mm	mm	inch	mm	mm		
25	20	3/4"	45.5	39	1005-73THE	1005-73THV
32	25	1"	45.5	45.5	1005-74THE	1005-74THV
40	32	1"1/4	47	58	1005-75THE	1005-75THV
50	40	1"1/2	42	64	1005-76THE	1005-76THV
63	50	2"	46.5	75	1005-77THE	1005-77THV

ACCESSOIRES DE CUVE
Accessories for IBC

SERIE 7051



N° Fiche produit - Product sheet
TDS-TANK-7051

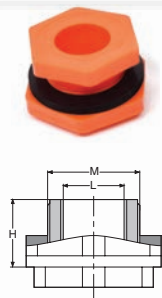

MANCHON DE FIXATION EN PP-H, FILETÉ - TARAUDÉ AVEC JOINT PLAT ET ÉCROU
PP-H tank connector, male threaded - female threaded, with gasket and nut

DIMENSIONS Dimensions			RÉFÉRENCE Product code
L inch	M inch	H mm	EPDM
1/2"	1"	30	7051-01EP
3/4"	1"1/4	30	7051-02EP

SERIE 2005



N° Fiche produit - Product sheet
TDS-TANK-7051



ADAPTATEUR EN PP-H TARAUDÉ PAS DU GAZ 2"- TARAUDÉ PAS ARTILLERIE 2" AVEC JOINT EN MOUSSE DE PE
Adapter in PP-H BSP female 2"- S60x6 (DIN61) female 2", with PE sealing

DIMENSIONS Dimensions		RÉFÉRENCE Product code
L mm	H mm	EPDM
73	48	2005-06V

quotes@tfpes.co.uk

Tel: 01626 201092

163

www.safi-valves.com

quotes@tipes.co.uk

ACTUATION

Tel: 01626 201092

164

www.safi-valves.com



MOTORISATION – Actuation

MOTORISATION – Actuation

Notre gamme « motorisation » couvre tous les produits permettant d'automatiser nos robinets.

Vous trouverez ainsi :

- . Une large gamme de kits d'interface ISO 5211
- . Nos robinets à membrane pneumatiques
- . Notre gamme d'actionneurs pneumatiques
- . Notre gamme d'actionneurs électriques
- . Ainsi que tous les accessoires associés.

En page 190, notre guide de motorisation vous permettra d'associer, pour chaque type et diamètre de robinet, les références des kits et actionneurs proposés.

Our «actuation» range covers all products which will actuate our valves.

You will find:

- . A wide range of ISO 5211 interface kits
- . Our pneumatic diaphragm valves
- . Our range of pneumatic actuators
- . Our range of electric actuators
- . As well as all associated accessories.

On page 190, our actuation guide associates, for each type and diameter of valves, the references of the proposed kits and actuators.

KIT DE MOTORISATION

Actuation kit

KIT



N° Fiche produit - Product sheet
TDS-KIT-0001

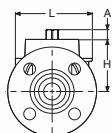

KIT DE MOTORISATION ISO 5211 (DOUILLE, ÉTRIER, VISSERIE) POUR ROBINET COMPACT À BRIDES SÉRIES 2014, 2029, 2091

ISO 5211 actuation kit (bracket, drive, screws) for flanged compact ball valve series 2014, 2029, 2091

DIMENSIONS					EMBASE ISO 5211	DOUILLE	RÉFÉRENCE
Dimensions					ISO 5211 plate	CARRÉ MÂLE 45° 45° square drive	Product code
DN	G	L	H	A			
mm	inch	mm	mm	mm		mm	
15	1/2"	71	62	15	F04/F05	11	KIT0130
15	1/2"	71	62	15	F04/F05	14	KIT0131
15	1/2"	71	62	15	F04/F05	17	KIT0132
20	3/4"	71	62	15	F04/F05	11	KIT0130
20	3/4"	71	62	15	F04/F05	14	KIT0131
20	3/4"	71	62	15	F04/F05	17	KIT0132
25	1"	91	69	17	F04/F05/F07	11	KIT0171
25	1"	91	69	17	F04/F05/F07	14	KIT0133
25	1"	91	69	17	F04/F05/F07	17	KIT0134
25	1"	91	69	17	F04/F05/F07	22	KIT0135
32	1"1/4	91	73	17	F04/F05/F07	11	KIT0171
32	1"1/4	91	73	17	F04/F05/F07	14	KIT0133
32	1"1/4	91	73	17	F04/F05/F07	17	KIT0134
32	1"1/4	91	73	17	F04/F05/F07	22	KIT0135
40	1"1/2	91	80	17	F04/F05/F07	11	KIT0172
40	1"1/2	91	80	17	F04/F05/F07	14	KIT0136
40	1"1/2	91	80	17	F04/F05/F07	17	KIT0137
40	1"1/2	91	80	17	F04/F05/F07	22	KIT0138
50	2"	91	84	17	F04/F05/F07	11	KIT0172
50	2"	91	84	17	F04/F05/F07	14	KIT0136
50	2"	91	84	17	F04/F05/F07	17	KIT0137
50	2"	91	84	17	F04/F05/F07	22	KIT0138

KIT DE MOTORISATION ISO 5211 (DOUILLE, ÉTRIER, VISSERIE) POUR ROBINET SANDWICH À BRIDES SÉRIES 1003, 2027, 2091

ISO 5211 actuation kit (bracket, drive, screws) for flanged ball valve series 1003, 2027, 2091

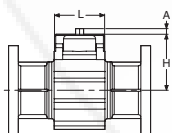

DIMENSIONS					EMBASE ISO 5211	DOUILLE	RÉFÉRENCE
Dimensions					ISO 5211 plate	CARRÉ MÂLE 45° 45° square drive	Product code
DN	G	L	H	A			
mm	inch	mm	mm	mm		mm	
80	3"	124	138	15	F05/F07	17	KIT0020
80	3"	124	138	21	F05/F07	22	KIT0022
80	3"	124	138	21	F10	22	KIT0153
80	3"	124	138	29	F10	27	KIT0399
100	4"	124	138	15	F05/F07	17	KIT0020
100	4"	124	138	21	F05/F07	22	KIT0022
100	4"	124	138	21	F10	22	KIT0153
100	4"	124	138	29	F10	27	KIT0399

quotes@tipes.co.uk

KIT DE MOTORISATION

Actuation kit

KIT



N° Fiche produit - Product sheet
TDS-KIT-0001

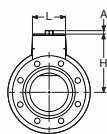

KIT DE MOTORISATION ISO 5211 (DOUILLE, ÉTRIER, VISSERIE) POUR ROBINET COMPACT À BRIDES SÉRIES 2008, 2029
ISO 5211 actuation kit (bracket, drive, screws) for flanged compact ball valve series 2008, 2029

DIMENSIONS					EMBASE ISO 5211	DOUILLE	RÉFÉRENCE
Dimensions					ISO 5211 plate	CARRÉ MÂLE 45° 45° square drive	Product code
DN	G	L	H	A		mm	
mm	inch	mm	mm	mm			
150	6"	129	226	15	F07	17	KIT0152
150	6"	129	226	15	F07	22	KIT0400
150	6"	129	226	21	F10	22	KIT0154
150	6"	129	226	24	F10	27	KIT0401

quotes@tfpes.co.uk

KIT DE MOTORISATION

Actuation kit

KIT



N° Fiche produit - Product sheet
TDS-KIT-0001

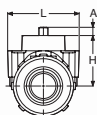

KIT DE MOTORISATION ISO 5211 (DOUILLE, ÉTRIER, VISSERIE) POUR ROBINET DOUBLE UNION SÉRIES 1003, 2027

ISO 5211 actuation kit (bracket, drive, screws) for double union ball valve series 1003, 2027

DIMENSIONS					EMBASE ISO 5211	DOUILLE	RÉFÉRENCE
Dimensions					ISO 5211 plate	CARRÉ MÂLE 45° 45° square drive	Product code
DN	G	L	H	A		mm	
mm	inch	mm	mm	mm			
15	1/2"	71	62	15	F04/F05	11	KIT0130
15	1/2"	71	62	15	F04/F05	14	KIT0131
15	1/2"	71	62	15	F04/F05	17	KIT0132
20	3/4"	71	62	15	F04/F05	11	KIT0130
20	3/4"	71	62	15	F04/F05	14	KIT0131
20	3/4"	71	62	15	F04/F05	17	KIT0132
25	1"	117	81	17	F05/F07	14	KIT0173
25	1"	117	81	17	F05/F07	17	KIT0174
25	1"	117	81	17	F05/F07	22	KIT0175
32	1"1/4	117	86	17	F05/F07	14	KIT0173
32	1"1/4	117	86	17	F05/F07	17	KIT0174
32	1"1/4	117	86	17	F05/F07	22	KIT0175
40	1"1/2	141	92	17	F05/F07	14	KIT0176
40	1"1/2	141	92	17	F05/F07	17	KIT0177
40	1"1/2	141	92	17	F05/F07	22	KIT0178
50	2"	141	97	17	F05/F07	14	KIT0176
50	2"	141	97	17	F05/F07	17	KIT0177
50	2"	141	97	17	F05/F07	22	KIT0178

quotes@tipes.co.uk

KIT DE MOTORISATION

Actuation kit

KIT



N° Fiche produit - Product sheet
TDS-KIT-0001

KIT DE MOTORISATION ISO 5211 (DOUILLE, ÉTRIER, VISSERIE) POUR ROBINET DOUBLE UNION 3 VOIES SÉRIES 2003, 2035

ISO 5211 actuation kit (bracket, drive, screws) for double union 3-way ball valve series 2003, 2035

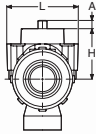

DIMENSIONS					EMBASE ISO 5211	DOUILLE CARRÉ MÂLE 45°	RÉFÉRENCE
Dimensions							
DN	G	L	H	A		mm	
mm	inch	mm	mm	mm			
15	1/2"	80	77.5	10	F04	11	KIT0010
15	1/2"	80	77.5	10	F05	14	KIT0006
20	3/4"	80	77.5	10	F04	11	KIT0010
20	3/4"	80	77.5	10	F05	14	KIT0006
25	1"	117	81	17	F05/F07	14	KIT0173
25	1"	117	81	17	F05/F07	17	KIT0174
25	1"	117	81	17	F05/F07	22	KIT0175
32	1"1/4	117	86	17	F05/F07	14	KIT0173
32	1"1/4	117	86	17	F05/F07	17	KIT0174
32	1"1/4	117	86	17	F05/F07	22	KIT0175
40	1"1/2	141	92	17	F05/F07	14	KIT0176
40	1"1/2	141	92	17	F05/F07	17	KIT0177
40	1"1/2	141	92	17	F05/F07	22	KIT0178
50	2"	141	97	17	F05/F07	14	KIT0176
50	2"	141	97	17	F05/F07	17	KIT0177
50	2"	141	97	17	F05/F07	22	KIT0178

KIT DE MOTORISATION ISO 5211 (DOUILLE, ÉTRIER, VISSERIE) POUR ROBINET DOUBLE UNION SÉRIES 3101, 3111, 3150

ISO 5211 actuation kit (bracket, drive, screws) for double union ball valve series 3101, 3111, 3150

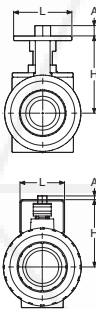

DIMENSIONS					EMBASE ISO 5211	DOUILLE CARRÉ MÂLE 45°	RÉFÉRENCE
Dimensions							
DN	G	L	H	A		mm	
mm	inch	mm	mm	mm			
15	1/2"	55	52	10	F03/F04	11	KIT0060
15	1/2"	55	52	10	F03/F04	14	KIT0061
20	3/4"	55	69	10	F04/F05	11	KIT0051
20	3/4"	55	69	10	F04/F05	14	KIT0062
25	1"	55	73	10	F04/F05	11	KIT0052
25	1"	55	73	10	F04/F05	14	KIT0063
32	1"1/4	55	96	11,5	F05	14	KIT0064
40	1"1/2	55	96	11,5	F05	14	KIT0064
50	2"	55	106	11,5	F05	14	KIT0066
50	2"	55	106	11,5	F05	17	KIT0067
65	2"1/2	105	130,5	14	F07	17	KIT0068
65	2"1/2	105	131	14	F07	22	KIT0069
80	3"	105	157	8,8	F07	17	KIT0070
80	3"	105	157	8,8	F07	22	KIT0071
80	3"	106	165	22	F07	27	KIT0397
100	4"	150	164	22	F07	17	KIT0396
100	4"	148	161,5	8,8	F07	22	KIT0072
100	4"	150	164	22	F07	27	KIT0398

quotes@tipes.co.uk

KIT DE MOTORISATION

Actuation kit

KIT



N° Fiche produit - Product sheet
TDS-KIT-0001

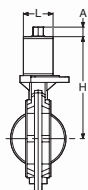

KIT DE MOTORISATION ISO 5211 (DOUILLE, ÉTRIER, VISSERIE) POUR ROBINET PAPILLON SÉRIES 3600, 3610, 3700, 3800 - DN50 À DN200

ISO 5211 actuation kit (bracket, drive, screws) for butterfly valve series 3600, 3610, 3700, 3800 - DN50 to DN200

DIMENSIONS					EMBASE ISO 5211 ISO 5211 plate	DOUILLE CARRÉ MÂLE 45° 45° square drive	RÉFÉRENCE Product code
DN	G	L	H	A			
mm	inch	mm	mm	mm		mm	
50	2"	80	175	15	F05	14	KIT0023
50	2"	80	175	18	F05	17	KIT0024
50	2"	100	175	23	F07	17	KIT0144
50	2"	80	175	23	F05	22	KIT0181
50	2"	80	171	26	F07	22	KIT0036
65	2"1/2	80	183	15	F05	14	KIT0023
65	2"1/2	80	183	18	F05	17	KIT0024
65	2"1/2	100	183	23	F07	17	KIT0144
65	2"1/2	80	183	23	F05	22	KIT0181
65	2"1/2	80	181	22	F07	22	KIT0036
80	3"	80	181	18	F05	17	KIT0024
80	3"	100	191	23	F07	17	KIT0162
80	3"	100	191	24	F07	22	KIT0164
100	4"	80	207	21	F05	17	KIT0404
100	4"	100	207	24	F07	17	KIT0005
100	4"	100	205	25	F07	22	KIT0402
100	4"	125	207	24	F10	22	KIT0165
100	4"	100	205	28	F10	27	KIT0403
125	5"	100	265	24	F05-F07	17	KIT0039
125	5"	100	265	24	F05-F07	22	KIT0083
125	5"	140	270	24	F10-F12	22	KIT0017
125	5"	140	270	29	F10-F12	27	KIT0148
150	6"	100	282	24	F05-F07	17	KIT0039
150	6"	100	282	24	F05-F07	22	KIT0083
150	6"	140	287	29	F10-F12	27	KIT0148
200	8"	180	279	24	F10-F12	22	KIT0038
200	8"	180	278	29	F10-F12	27	KIT0163
200	8"	180	279	36	F10-F12	36	KIT0166

Pour commander un robinet papillon prêt pour motorisation, rajouter la référence ACTUREADY après celle du robinet. Par exemple 3600-05WWE + ACTUREADY
- pour les DN50 à 200 : la poignée crantée est enlevée, la face est dressée et percée

To order a butterfly valve ready for actuation, please add the code ACTUREADY after the code of the valve. For example 3600-05WWE + ACTUREADY
- for DN50 to 200 : the handle is removed, the face is machined and drilled

KIT DE MOTORISATION
Actuation kit

KIT



N° Fiche produit - Product sheet
TDS-KIT-0001

KIT DE MOTORISATION ISO 5211 (DOUILLE, ÉTRIER, VISSERIE) POUR ROBINET PAPILLON
SÉRIES 3600, 3610, 3700, 3800 - DN250 À DN500

ISO 5211 actuation kit (bracket, drive, screws) for butterfly valve series 3600, 3610, 3700, 3800 - DN250 to DN500

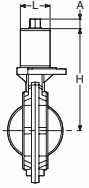

DIMENSIONS					EMBASE ISO 5211 ISO 5211 plate	DOUILLE CARRÉ MÂLE 45° 45° square drive	RÉFÉRENCE Product code
DN	G	L	H	A			
mm	inch	mm	mm	mm		mm	
250	10"	180	317	29	F10-F12	27	KIT0163
250	10"	180	317	36	F10-F12	36	KIT0182
250	10"	180	317	36	F14-F16	36	KIT0115
250	10"	180	317	46	F14-F16	46	KIT0141
300	12"	180	363	36	F10-F12	36	KIT0193
300	12"	180	364	36	F14-F16	36	KIT0032
300	12"	180	364	46	F14-F16	46	KIT0140
350	14"	180	380	36	F10-F12	36	KIT0193
350	14"	180	380	36	F14-F16	36	KIT0032
350	14"	180	380	46	F14-F16	46	KIT0140
400	16"	300	493	36	F14-F16	36	KIT0142
400	16"	300	493	46	F14-F16	46	KIT0167
450	18"	300	495	36	F14-F16	36	KIT0168
450	18"	300	495	46	F14-F16	46	KIT0167
500	20"	300	535	36	F14-F16	36	KIT0168
500	20"	300	535	46	F16	46	KIT0169

Pour commander un robinet papillon prêt pour motorisation, rajouter la référence ACTUREADY après celle du robinet. Par exemple 3600-05WWE + ACTUREADY
- pour les DN250 et supérieurs : le réducteur est enlevé
To order a butterfly valve ready for actuation, please add the code ACTUREADY after the code of the valve. For example 3600-05WWE + ACTUREADY
- for DN250 and higher : the gearbox is removed

quotes@tfpses.co.uk

ROBINET À MEMBRANE MOTORISÉ

Actuated diaphragm valve

SERIE 2307



N° Fiche produit - Product sheet
TDS-DIAPH-2300

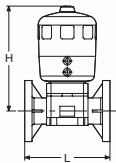

ROBINET PVC-U À MEMBRANE À BRIDES, ÉQUIPÉ D'UN ACTIONNEUR PNEUMATIQUE DOUBLE-EFFET (DE)

Flanged PVC-U diaphragm valve, equipped with double acting (DA) pneumatic actuator

DIMENSIONS Dimensions					RÉFÉRENCE (BRIDES DIN*) Product code (DIN flanges*)			RÉFÉRENCE (BRIDES ANSI*) Product code (ANSI flanges*)			PN bar
d mm	DN mm	G inch	L mm	H mm	EPDM	FPM	PTFE	EPDM	FPM	PTFE	
20	15	1/2"	130	174	2307-00FFE	2307-00FFZ	2307-00FFP	2307-00GGE	2307-00GGZ	2307-00GGP	10
25	20	3/4"	150	174	2307-01FFE	2307-01FFZ	2307-01FFP	2307-01GGE	2307-01GGZ	2307-01GGP	10
32	25	1"	160	174	2307-02FFE	2307-02FFZ	2307-02FFP	2307-02GGE	2307-02GGZ	2307-02GGP	10
40	32	1"1/4	180	236	2307-03FFE	2307-03FFZ	2307-03FFP	2307-03GGE	2307-03GGZ	2307-03GGP	10
50	40	1"1/2	200	236	2307-04FFE	2307-04FFZ	2307-04FFP	2307-04GGE	2307-04GGZ	2307-04GGP	10
63	50	2"	230	283	2307-05FFE	2307-05FFZ	2307-05FFP	2307-05GGE	2307-05GGZ	2307-05GGP	10

* DIN = EN1092-1 PN10/16

ANSI = ASME B1.6.5 Class 150

ROBINET PVC-U À MEMBRANE, DOUBLE UNION, EMBOUTS PVC-U FEMELLES MÉTRIQUES, ÉQUIPÉ D'UN ACTIONNEUR PNEUMATIQUE DOUBLE-EFFET (DE)

PVC-U diaphragm valve, double union, PVC-U metric sockets, equipped with double acting (DA) pneumatic actuator

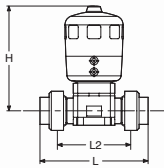

DIMENSIONS Dimensions						RÉFÉRENCE Product code			PN bar
d mm	DN mm	G inch	L mm	L2 mm	H mm	EPDM	FPM	PTFE	
20	15	1/2"	177	135	174	2307-00BBE	2307-00BBZ	2307-00BBP	10
25	20	3/4"	181	132	174	2307-01BBE	2307-01BBZ	2307-01BBP	10
32	25	1"	186	133	174	2307-02BBE	2307-02BBZ	2307-02BBP	10
40	32	1"1/4	228	166	236	2307-03BBE	2307-03BBZ	2307-03BBP	10
50	40	1"1/2	253	178	236	2307-04BBE	2307-04BBZ	2307-04BBP	10
63	50	2"	287	199	283	2307-05BBE	2307-05BBZ	2307-05BBP	10

ROBINET PVC-U À MEMBRANE, SORTIES PVC-U MÂLES, ÉQUIPÉ D'UN ACTIONNEUR PNEUMATIQUE DOUBLE-EFFET (DE)

PVC-U diaphragm valve, PVC-U metric spigot outlets, equipped with double acting (DA) pneumatic actuator

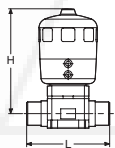

DIMENSIONS Dimensions					RÉFÉRENCE Product code			PN bar
d mm	DN mm	G inch	L mm	H mm	EPDM	FPM	PTFE	
20	15	1/2"	124	174	2307-00ZZE	2307-00ZZZ	2307-00ZZP	10
25	20	3/4"	144	174	2307-01ZZE	2307-01ZZZ	2307-01ZZP	10
32	25	1"	154	174	2307-02ZZE	2307-02ZZZ	2307-02ZZP	10
40	32	1"1/4	174	236	2307-03ZZE	2307-03ZZZ	2307-03ZZP	10
50	40	1"1/2	194	236	2307-04ZZE	2307-04ZZZ	2307-04ZZP	10
63	50	2"	224	283	2307-05ZZE	2307-05ZZZ	2307-05ZZP	10

quotes@tipes.co.uk

ROBINET À MEMBRANE MOTORISÉ

Actuated diaphragm valve

SERIE 2308



N° Fiche produit - Product sheet
TDS-DIAPH-2300

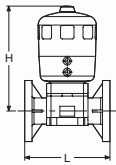

ROBINET PVC-U À MEMBRANE À BRIDES, ÉQUIPÉ D'UN ACTIONNEUR PNEUMATIQUE SIMPLE EFFET NORMALEMENT OUVERT (SE/NO)

Flanged PVC-U diaphragm valve, equipped with failsafe normally open (NO) pneumatic actuator

DIMENSIONS Dimensions					RÉFÉRENCE (BRIDES DIN*) Product code (DIN flanges*)			RÉFÉRENCE (BRIDES ANSI*) Product code (ANSI flanges*)			PN bar
d mm	DN mm	G inch	L mm	H mm	EPDM	FPM	PTFE	EPDM	FPM	PTFE	
20	15	1/2"	130	174	2308-00FFE	2308-00FFZ	2308-00FFP	2308-00GGE	2308-00GGZ	2308-00GGP	10
25	20	3/4"	150	174	2308-01FFE	2308-01FFZ	2308-01FFP	2308-01GGE	2308-01GGZ	2308-01GGP	10
32	25	1"	160	174	2308-02FFE	2308-02FFZ	2308-02FFP	2308-02GGE	2308-02GGZ	2308-02GGP	10
40	32	1"1/4	180	236	2308-03FFE	2308-03FFZ	2308-03FFP	2308-03GGE	2308-03GGZ	2308-03GGP	10
50	40	1"1/2	200	236	2308-04FFE	2308-04FFZ	2308-04FFP	2308-04GGE	2308-04GGZ	2308-04GGP	10
63	50	2"	230	283	2308-05FFE	2308-05FFZ	2308-05FFP	2308-05GGE	2308-05GGZ	2308-05GGP	10

* DIN = EN1092-1 PN10/16

ANSI = ASME B16.5 Class 150

ROBINET PVC-U À MEMBRANE, DOUBLE UNION, EMBOUTS PVC-U FEMELLES MÉTRIQUES, ÉQUIPÉ D'UN ACTIONNEUR PNEUMATIQUE SIMPLE EFFET NORMALEMENT OUVERT (SE/NO)

PVC-U diaphragm valve, double union, PVC-U metric sockets, equipped with failsafe normally open (NO) pneumatic actuator

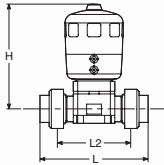

DIMENSIONS Dimensions						RÉFÉRENCE Product code			PN bar
d mm	DN mm	G inch	L mm	L2 mm	H mm	EPDM	FPM	PTFE	
20	15	1/2"	177	135	174	2308-00BBE	2308-00BBZ	2308-00BBP	10
25	20	3/4"	181	132	174	2308-01BBE	2308-01BBZ	2308-01BBP	10
32	25	1"	186	133	174	2308-02BBE	2308-02BBZ	2308-02BBP	10
40	32	1"1/4	228	166	236	2308-03BBE	2308-03BBZ	2308-03BBP	10
50	40	1"1/2	253	178	236	2308-04BBE	2308-04BBZ	2308-04BBP	10
63	50	2"	287	199	283	2308-05BBE	2308-05BBZ	2308-05BBP	10

ROBINET PVC-U À MEMBRANE, SORTIES PVC-U MÂLES, ÉQUIPÉ D'UN ACTIONNEUR PNEUMATIQUE SIMPLE EFFET NORMALEMENT OUVERT (SE/NO)

PVC-U diaphragm valve, PVC-U metric spigot outlets, equipped with failsafe normally open (NO) pneumatic actuator

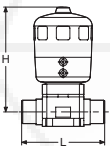

DIMENSIONS Dimensions					RÉFÉRENCE Product code			PN bar
d mm	DN mm	G inch	L mm	H mm	EPDM	FPM	PTFE	
20	15	1/2"	124	174	2308-00ZZE	2308-00ZZZ	2308-00ZZP	10
25	20	3/4"	144	174	2308-01ZZE	2308-01ZZZ	2308-01ZZP	10
32	25	1"	154	174	2308-02ZZE	2308-02ZZZ	2308-02ZZP	10
40	32	1"1/4	174	236	2308-03ZZE	2308-03ZZZ	2308-03ZZP	10
50	40	1"1/2	194	236	2308-04ZZE	2308-04ZZZ	2308-04ZZP	10
63	50	2"	224	283	2308-05ZZE	2308-05ZZZ	2308-05ZZP	10

quotes@tipes.co.uk

ROBINET À MEMBRANE MOTORISÉ

Actuated diaphragm valve

SERIE 2309



N° Fiche produit - Product sheet
TDS-DIAPH-2300

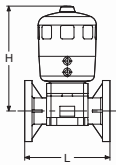

ROBINET PVC-U À MEMBRANE À BRIDES, ÉQUIPÉ D'UN ACTIONNEUR PNEUMATIQUE SIMPLE EFFET NORMALEMENT FERMÉ (SE/NF)

Flanged PVC-U diaphragm valve, equipped with failsafe normally closed (NC) pneumatic actuator

DIMENSIONS Dimensions					RÉFÉRENCE (BRIDES DIN*) Product code (DIN flanges*)			RÉFÉRENCE (BRIDES ANSI*) Product code (ANSI flanges*)			PN bar
d mm	DN mm	G inch	L mm	H mm	EPDM	FPM	PTFE	EPDM	FPM	PTFE	
20	15	1/2"	130	174	2309-00FFE	2309-00FFZ	2309-00FFP	2309-00GGE	2309-00GGZ	2309-00GGP	10
25	20	3/4"	150	174	2309-01FFE	2309-01FFZ	2309-01FFP	2309-01GGE	2309-01GGZ	2309-01GGP	10
32	25	1"	160	174	2309-02FFE	2309-02FFZ	2309-02FFP	2309-02GGE	2309-02GGZ	2309-02GGP	10
40	32	1"1/4	180	236	2309-03FFE	2309-03FFZ	2309-03FFP	2309-03GGE	2309-03GGZ	2309-03GGP	10
50	40	1"1/2	200	236	2309-04FFE	2309-04FFZ	2309-04FFP	2309-04GGE	2309-04GGZ	2309-04GGP	10
63	50	2"	230	283	2309-05FFE	2309-05FFZ	2309-05FFP	2309-05GGE	2309-05GGZ	2309-05GGP	10

* DIN = EN1092-1 PN10/16

ANSI = ASME B16.5 Class 150

ROBINET PVC-U À MEMBRANE, DOUBLE UNION, EMBOUTS PVC-U FEMELLES MÉTRIQUES, ÉQUIPÉ D'UN ACTIONNEUR PNEUMATIQUE SIMPLE EFFET NORMALEMENT FERMÉ (SE/NF)

PVC-U diaphragm valve, double union, PVC-U metric sockets, equipped with failsafe normally closed (NC) pneumatic actuator

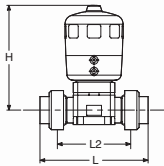

DIMENSIONS Dimensions						RÉFÉRENCE Product code			PN bar
d mm	DN mm	G inch	L mm	L2 mm	H mm	EPDM	FPM	PTFE	
20	15	1/2"	177	135	174	2309-00BBE	2309-00BBZ	2309-00BBP	10
25	20	3/4"	181	132	174	2309-01BBE	2309-01BBZ	2309-01BBP	10
32	25	1"	186	133	174	2309-02BBE	2309-02BBZ	2309-02BBP	10
40	32	1"1/4	228	166	236	2309-03BBE	2309-03BBZ	2309-03BBP	10
50	40	1"1/2	253	178	236	2309-04BBE	2309-04BBZ	2309-04BBP	10
63	50	2"	287	199	283	2309-05BBE	2309-05BBZ	2309-05BBP	10

ROBINET PVC-U À MEMBRANE, SORTIES PVC-U MÂLES, ÉQUIPÉ D'UN ACTIONNEUR PNEUMATIQUE SIMPLE EFFET NORMALEMENT FERMÉ (SE/NF)

PVC-U diaphragm valve, PVC-U metric spigot outlets, equipped with failsafe normally closed (NC) pneumatic actuator

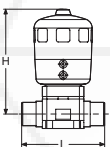

DIMENSIONS Dimensions					RÉFÉRENCE Product code			PN bar
d mm	DN mm	G inch	L mm	H mm	EPDM	FPM	PTFE	
20	15	1/2"	124	174	2309-00ZZE	2309-00ZZZ	2309-00ZZP	10
25	20	3/4"	144	174	2309-01ZZE	2309-01ZZZ	2309-01ZZP	10
32	25	1"	154	174	2309-02ZZE	2309-02ZZZ	2309-02ZZP	10
40	32	1"1/4	174	236	2309-03ZZE	2309-03ZZZ	2309-03ZZP	10
50	40	1"1/2	194	236	2309-04ZZE	2309-04ZZZ	2309-04ZZP	10
63	50	2"	224	283	2309-05ZZE	2309-05ZZZ	2309-05ZZP	10

quotes@tipes.co.uk

ROBINET À MEMBRANE MOTORISÉ

Actuated diaphragm valve

SERIE 2107



N° Fiche produit - Product sheet
TDS-DIAPH-2300

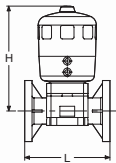

ROBINET PP-H À MEMBRANE À BRIDES, ÉQUIPÉ D'UN ACTIONNEUR PNEUMATIQUE DOUBLE-EFFET (DE)

Flanged PP-H diaphragm valve, equipped with double acting (DA) pneumatic actuator

DIMENSIONS					RÉFÉRENCE (BRIDES DIN*)			RÉFÉRENCE (BRIDES ANSI*)			PN bar
d	DN	G	L	H	Product code (DIN flanges*)			Product code (ANSI flanges*)			
mm	mm	inch	mm	mm	EPDM	FPM	PTFE	EPDM	FPM	PTFE	
20	15	1/2"	130	174	2107-00FFE	2107-00FFZ	2107-00FFP	2107-00GGE	2107-00GGZ	2107-00GGP	10
25	20	3/4"	150	174	2107-01FFE	2107-01FFZ	2107-01FFP	2107-01GGE	2107-01GGZ	2107-01GGP	10
32	25	1"	160	174	2107-02FFE	2107-02FFZ	2107-02FFP	2107-02GGE	2107-02GGZ	2107-02GGP	10
40	32	1"1/4	180	236	2107-03FFE	2107-03FFZ	2107-03FFP	2107-03GGE	2107-03GGZ	2107-03GGP	10
50	40	1"1/2	200	236	2107-04FFE	2107-04FFZ	2107-04FFP	2107-04GGE	2107-04GGZ	2107-04GGP	10
63	50	2"	230	283	2107-05FFE	2107-05FFZ	2107-05FFP	2107-05GGE	2107-05GGZ	2107-05GGP	10

* DIN = EN1092-1 PN10/16

ANSI = ASME B16.5 Class 150

ROBINET PP-H À MEMBRANE, DOUBLE UNION, EMBOUTS PP-H FEMELLES MÉTRIQUES, ÉQUIPÉ D'UN ACTIONNEUR PNEUMATIQUE DOUBLE-EFFET (DE)

PP-H diaphragm valve, double union, PP-H metric sockets, equipped with double acting (DA) pneumatic actuator

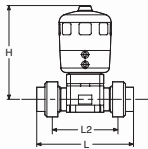

DIMENSIONS						RÉFÉRENCE			PN bar
d	DN	G	L	L2	H	Product code			
mm	mm	inch	mm	mm	mm	EPDM	FPM	PTFE	
20	15	1/2"	177	135	174	2107-00CCE	2107-00CCZ	2107-00CCP	10
25	20	3/4"	177	132	174	2107-01CCE	2107-01CCZ	2107-01CCP	10
32	25	1"	182	134	174	2107-02CCE	2107-02CCZ	2107-02CCP	10
40	32	1"1/4	220	166	236	2107-03CCE	2107-03CCZ	2107-03CCP	10
50	40	1"1/2	238	177	236	2107-04CCE	2107-04CCZ	2107-04CCP	10
63	50	2"	268	197	283	2107-05CCE	2107-05CCZ	2107-05CCP	10

ROBINET PP-H À MEMBRANE, SORTIES PP-H MÂLES, ÉQUIPÉ D'UN ACTIONNEUR PNEUMATIQUE DOUBLE-EFFET (DE)

PP-H diaphragm valve, PP-H metric spigot outlets, equipped with double acting (DA) pneumatic actuator

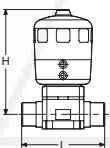

DIMENSIONS					RÉFÉRENCE			PN bar
d	DN	G	L	H	Product code			
mm	mm	inch	mm	mm	EPDM	FPM	PTFE	
20	15	1/2"	123	174	2107-00ZZE	2107-00ZZZ	2107-00ZZP	10
25	20	3/4"	143	174	2107-01ZZE	2107-01ZZZ	2107-01ZZP	10
32	25	1"	154	174	2107-02ZZE	2107-02ZZZ	2107-02ZZP	10
40	32	1"1/4	175	236	2107-03ZZE	2107-03ZZZ	2107-03ZZP	10
50	40	1"1/2	193	236	2107-04ZZE	2107-04ZZZ	2107-04ZZP	10
63	50	2"	224	283	2107-05ZZE	2107-05ZZZ	2107-05ZZP	10

quotes@tipes.co.uk

ROBINET À MEMBRANE MOTORISÉ

Actuated diaphragm valve

SERIE 2108



N° Fiche produit - Product sheet
TDS-DIAPH-2300

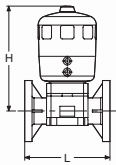

ROBINET PP-H À MEMBRANE À BRIDES, ÉQUIPÉ D'UN ACTIONNEUR PNEUMATIQUE SIMPLE EFFET NORMALEMENT OUVERT (SE/NO)

Flanged PP-H diaphragm valve, equipped with failsafe normally open (NO) pneumatic actuator

DIMENSIONS Dimensions					RÉFÉRENCE (BRIDES DIN*) Product code (DIN flanges*)			RÉFÉRENCE (BRIDES ANSI*) Product code (ANSI flanges*)			PN bar
d mm	DN mm	G inch	L mm	H mm	EPDM	FPM	PTFE	EPDM	FPM	PTFE	
20	15	1/2"	130	174	2108-00FFE	2108-00FFZ	2108-00FFP	2108-00GGE	2108-00GGZ	2108-00GGP	10
25	20	3/4"	150	174	2108-01FFE	2108-01FFZ	2108-01FFP	2108-01GGE	2108-01GGZ	2108-01GGP	10
32	25	1"	160	174	2108-02FFE	2108-02FFZ	2108-02FFP	2108-02GGE	2108-02GGZ	2108-02GGP	10
40	32	1"1/4	180	236	2108-03FFE	2108-03FFZ	2108-03FFP	2108-03GGE	2108-03GGZ	2108-03GGP	10
50	40	1"1/2	200	236	2108-04FFE	2108-04FFZ	2108-04FFP	2108-04GGE	2108-04GGZ	2108-04GGP	10
63	50	2"	230	283	2108-05FFE	2108-05FFZ	2108-05FFP	2108-05GGE	2108-05GGZ	2108-05GGP	10

* DIN = EN1092-1 PN10/16

ANSI = ASME B16.5 Class 150

ROBINET PP-H À MEMBRANE, DOUBLE UNION, EMBOUTS PP-H FEMELLES MÉTRIQUES, ÉQUIPÉ D'UN ACTIONNEUR PNEUMATIQUE SIMPLE EFFET NORMALEMENT OUVERT (SE/NO)

PP-H diaphragm valve, double union, PP-H metric sockets, equipped with failsafe normally open (NO) pneumatic actuator

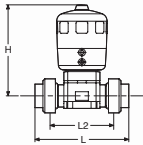

DIMENSIONS Dimensions						RÉFÉRENCE Product code			PN bar
d mm	DN mm	G inch	L mm	L2 mm	H mm	EPDM	FPM	PTFE	
20	15	1/2"	177	135	174	2108-00CCE	2108-00CCZ	2108-00CCP	10
25	20	3/4"	177	132	174	2108-01CCE	2108-01CCZ	2108-01CCP	10
32	25	1"	182	134	174	2108-02CCE	2108-02CCZ	2108-02CCP	10
40	32	1"1/4	220	166	236	2108-03CCE	2108-03CCZ	2108-03CCP	10
50	40	1"1/2	238	177	236	2108-04CCE	2108-04CCZ	2108-04CCP	10
63	50	2"	268	197	283	2108-05CCE	2108-05CCZ	2108-05CCP	10

ROBINET PP-H À MEMBRANE, SORTIES PP-H MÂLES, ÉQUIPÉ D'UN ACTIONNEUR PNEUMATIQUE SIMPLE EFFET NORMALEMENT OUVERT (SE/NO)

PP-H diaphragm valve, PP-H metric spigot outlets, equipped with failsafe normally open (NO) pneumatic actuator

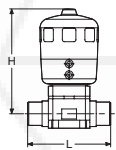

DIMENSIONS Dimensions					RÉFÉRENCE Product code			PN bar
d mm	DN mm	G inch	L mm	H mm	EPDM	FPM	PTFE	
20	15	1/2"	123	174	2108-00ZZE	2108-00ZZZ	2108-00ZZP	10
25	20	3/4"	143	174	2108-01ZZE	2108-01ZZZ	2108-01ZZP	10
32	25	1"	154	174	2108-02ZZE	2108-02ZZZ	2108-02ZZP	10
40	32	1"1/4	175	236	2108-03ZZE	2108-03ZZZ	2108-03ZZP	10
50	40	1"1/2	193	236	2108-04ZZE	2108-04ZZZ	2108-04ZZP	10
63	50	2"	224	283	2108-05ZZE	2108-05ZZZ	2108-05ZZP	10

quotes@tipes.co.uk

ROBINET À MEMBRANE MOTORISÉ

Actuated diaphragm valve

SERIE 2109



N° Fiche produit - Product sheet
TDS-DIAPH-2300

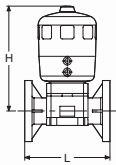

ROBINET PP-H À MEMBRANE À BRIDES, ÉQUIPÉ D'UN ACTIONNEUR PNEUMATIQUE SIMPLE EFFET NORMALEMENT FERMÉ (SE/NF)

Flanged PP-H diaphragm valve, equipped with failsafe normally closed (NC) pneumatic actuator

DIMENSIONS Dimensions					RÉFÉRENCE (BRIDES DIN*) Product code (DIN flanges*)			RÉFÉRENCE (BRIDES ANSI*) Product code (ANSI flanges*)			PN bar
d mm	DN mm	G inch	L mm	H mm	EPDM	FPM	PTFE	EPDM	FPM	PTFE	
20	15	1/2"	130	174	2109-00FFE	2109-00FFZ	2109-00FFP	2109-00GGE	2109-00GGZ	2109-00GGP	10
25	20	3/4"	150	174	2109-01FFE	2109-01FFZ	2109-01FFP	2109-01GGE	2109-01GGZ	2109-01GGP	10
32	25	1"	160	174	2109-02FFE	2109-02FFZ	2109-02FFP	2109-02GGE	2109-02GGZ	2109-02GGP	10
40	32	1"1/4	180	236	2109-03FFE	2109-03FFZ	2109-03FFP	2109-03GGE	2109-03GGZ	2109-03GGP	10
50	40	1"1/2	200	236	2109-04FFE	2109-04FFZ	2109-04FFP	2109-04GGE	2109-04GGZ	2109-04GGP	10
63	50	2"	230	283	2109-05FFE	2109-05FFZ	2109-05FFP	2109-05GGE	2109-05GGZ	2109-05GGP	10

* DIN = EN1092-1 PN10/16

ANSI = ASME B16.5 Class 150

ROBINET PP-H À MEMBRANE, DOUBLE UNION, EMBOUTS PP-H FEMELLES MÉTRIQUES, ÉQUIPÉ D'UN ACTIONNEUR PNEUMATIQUE SIMPLE EFFET NORMALEMENT FERMÉ (SE/NF)

PP-H diaphragm valve, double union, PP-H metric sockets, equipped with failsafe normally closed (NC) pneumatic actuator

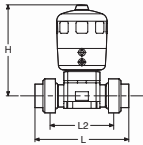

DIMENSIONS Dimensions						RÉFÉRENCE Product code			PN bar
d mm	DN mm	G inch	L mm	L2 mm	H mm	EPDM	FPM	PTFE	
20	15	1/2"	177	135	174	2109-00CCE	2109-00CCZ	2109-00CCP	10
25	20	3/4"	177	132	174	2109-01CCE	2109-01CCZ	2109-01CCP	10
32	25	1"	182	134	174	2109-02CCE	2109-02CCZ	2109-02CCP	10
40	32	1"1/4	220	166	236	2109-03CCE	2109-03CCZ	2109-03CCP	10
50	40	1"1/2	238	177	236	2109-04CCE	2109-04CCZ	2109-04CCP	10
63	50	2"	268	197	283	2109-05CCE	2109-05CCZ	2109-05CCP	10

ROBINET PP-H À MEMBRANE, SORTIES PP-H MÂLES, ÉQUIPÉ D'UN ACTIONNEUR PNEUMATIQUE SIMPLE EFFET NORMALEMENT FERMÉ (SE/NF)

PP-H diaphragm valve, PP-H metric spigot outlets, equipped with failsafe normally closed (NC) pneumatic actuator

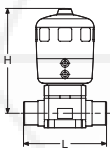

DIMENSIONS Dimensions					RÉFÉRENCE Product code			PN bar
d mm	DN mm	G inch	L mm	H mm	EPDM	FPM	PTFE	
20	15	1/2"	123	174	2109-00ZZE	2109-00ZZZ	2109-00ZZP	10
25	20	3/4"	143	174	2109-01ZZE	2109-01ZZZ	2109-01ZZP	10
32	25	1"	154	174	2109-02ZZE	2109-02ZZZ	2109-02ZZP	10
40	32	1"1/4	175	236	2109-03ZZE	2109-03ZZZ	2109-03ZZP	10
50	40	1"1/2	193	236	2109-04ZZE	2109-04ZZZ	2109-04ZZP	10
63	50	2"	224	283	2109-05ZZE	2109-05ZZZ	2109-05ZZP	10

ROBINET À MEMBRANE MOTORISÉ

Actuated diaphragm valve

SERIE 2207



N° Fiche produit - Product sheet
TDS-DIAPH-2300

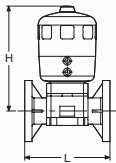

ROBINET PVDF À MEMBRANE À BRIDES, ÉQUIPÉ D'UN ACTIONNEUR PNEUMATIQUE DOUBLE-EFFET (DE)

Flanged PVDF diaphragm valve, equipped with double acting (DA) pneumatic actuator

DIMENSIONS					RÉFÉRENCE (BRIDES DIN*)			RÉFÉRENCE (BRIDES ANSI*)			PN
Dimensions					Product code (DIN flanges*)			Product code (ANSI flanges*)			
d	DN	G	L	H	EPDM	FPM	PTFE	EPDM	FPM	PTFE	bar
mm	mm	inch	mm	mm							
20	15	1/2"	130	174	2207-00FFE	2207-00FFZ	2207-00FFP	2207-00GGE	2207-00GGZ	2207-00GGP	10
25	20	3/4"	150	174	2207-01FFE	2207-01FFZ	2207-01FFP	2207-01GGE	2207-01GGZ	2207-01GGP	10
32	25	1"	160	174	2207-02FFE	2207-02FFZ	2207-02FFP	2207-02GGE	2207-02GGZ	2207-02GGP	10
40	32	1 1/4"	180	236	2207-03FFE	2207-03FFZ	2207-03FFP	2207-03GGE	2207-03GGZ	2207-03GGP	10
50	40	1 1/2"	200	236	2207-04FFE	2207-04FFZ	2207-04FFP	2207-04GGE	2207-04GGZ	2207-04GGP	10
63	50	2"	230	283	2207-05FFE	2207-05FFZ	2207-05FFP	2207-05GGE	2207-05GGZ	2207-05GGP	10

* DIN = EN1092-1 PN10/16

ANSI = ASME B16.5 Class 150

ROBINET PVDF À MEMBRANE, DOUBLE UNION, EMBOUTS PVDF FEMELLES MÉTRIQUES, ÉQUIPÉ D'UN ACTIONNEUR PNEUMATIQUE DOUBLE-EFFET (DE)

PVDF diaphragm valve, double union, PVDF metric sockets, equipped with double acting (DA) pneumatic actuator

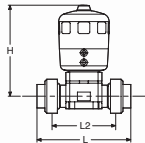

DIMENSIONS						RÉFÉRENCE			PN
Dimensions						Product code			
d	DN	G	L	L2	H	EPDM	FPM	PTFE	bar
mm	mm	inch	mm	mm	mm				
20	15	1/2"	177	134	174	2207-00CCE	2207-00CCZ	2207-00CCP	10
25	20	3/4"	176	134	174	2207-01CCE	2207-01CCZ	2207-01CCP	10
32	25	1"	182	133	174	2207-02CCE	2207-02CCZ	2207-02CCP	10
40	32	1 1/4"	217	165	236	2207-03CCE	2207-03CCZ	2207-03CCP	10
50	40	1 1/2"	240	178	236	2207-04CCE	2207-04CCZ	2207-04CCP	10
63	50	2"	269	197	283	2207-05CCE	2207-05CCZ	2207-05CCP	10

ROBINET PVDF À MEMBRANE, SORTIES PVDF MÂLES, ÉQUIPÉ D'UN ACTIONNEUR PNEUMATIQUE DOUBLE-EFFET (DE)

PVDF diaphragm valve, PVDF metric spigot outlets, equipped with double acting (DA) pneumatic actuator

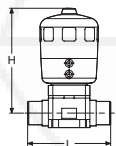

DIMENSIONS					RÉFÉRENCE			PN
Dimensions					Product code			
d	DN	G	L	H	EPDM	FPM	PTFE	bar
mm	mm	inch	mm	mm				
20	15	1/2"	124	174	2207-00ZZE	2207-00ZZZ	2207-00ZZP	10
25	20	3/4"	143	174	2207-01ZZE	2207-01ZZZ	2207-01ZZP	10
32	25	1"	154	174	2207-02ZZE	2207-02ZZZ	2207-02ZZP	10
40	32	1 1/4"	174	236	2207-03ZZE	2207-03ZZZ	2207-03ZZP	10
50	40	1 1/2"	194	236	2207-04ZZE	2207-04ZZZ	2207-04ZZP	10
63	50	2"	224	283	2207-05ZZE	2207-05ZZZ	2207-05ZZP	10

quotes@tipes.co.uk

ROBINET À MEMBRANE MOTORISÉ

Actuated diaphragm valve

SERIE 2208



N° Fiche produit - Product sheet
TDS-DIAPH-2300

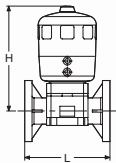

ROBINET PVDF À MEMBRANE À BRIDES, ÉQUIPÉ D'UN ACTIONNEUR PNEUMATIQUE SIMPLE EFFET NORMALEMENT OUVERT (SE/NO)

Flanged PVDF diaphragm valve, equipped with failsafe normally open (NO) pneumatic actuator

DIMENSIONS Dimensions					RÉFÉRENCE (BRIDES DIN*) Product code (DIN flanges*)			RÉFÉRENCE (BRIDES ANSI*) Product code (ANSI flanges*)			PN bar
d mm	DN mm	G inch	L mm	H mm	EPDM	FPM	PTFE	EPDM	FPM	PTFE	
20	15	1/2"	130	174	2208-00FFE	2208-00FFZ	2208-00FFP	2208-00GGE	2208-00GGZ	2208-00GGP	10
25	20	3/4"	150	174	2208-01FFE	2208-01FFZ	2208-01FFP	2208-01GGE	2208-01GGZ	2208-01GGP	10
32	25	1"	160	174	2208-02FFE	2208-02FFZ	2208-02FFP	2208-02GGE	2208-02GGZ	2208-02GGP	10
40	32	1"1/4	180	236	2208-03FFE	2208-03FFZ	2208-03FFP	2208-03GGE	2208-03GGZ	2208-03GGP	10
50	40	1"1/2	200	236	2208-04FFE	2208-04FFZ	2208-04FFP	2208-04GGE	2208-04GGZ	2208-04GGP	10
63	50	2"	230	283	2208-05FFE	2208-05FFZ	2208-05FFP	2208-05GGE	2208-05GGZ	2208-05GGP	10

* DIN = EN1092-1 PN10/16

ANSI = ASME B16.5 Class 150

ROBINET PVDF À MEMBRANE, DOUBLE UNION, EMBOUTS PVDF FEMELLES MÉTRIQUES, ÉQUIPÉ D'UN ACTIONNEUR PNEUMATIQUE SIMPLE EFFET NORMALEMENT OUVERT (SE/NO)

PVDF diaphragm valve, double union, PVDF metric sockets, equipped with failsafe normally open (NO) pneumatic actuator

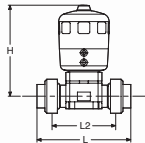

DIMENSIONS Dimensions						RÉFÉRENCE Product code			PN bar
d mm	DN mm	G inch	L mm	L2 mm	H mm	EPDM	FPM	PTFE	
20	15	1/2"	177	134	174	2208-00CCE	2208-00CCZ	2208-00CCP	10
25	20	3/4"	176	134	174	2208-01CCE	2208-01CCZ	2208-01CCP	10
32	25	1"	182	133	174	2208-02CCE	2208-02CCZ	2208-02CCP	10
40	32	1"1/4	217	165	236	2208-03CCE	2208-03CCZ	2208-03CCP	10
50	40	1"1/2	240	178	236	2208-04CCE	2208-04CCZ	2208-04CCP	10
63	50	2"	269	197	283	2208-05CCE	2208-05CCZ	2208-05CCP	10

ROBINET PVDF À MEMBRANE, SORTIES PVDF MÂLES, ÉQUIPÉ D'UN ACTIONNEUR PNEUMATIQUE SIMPLE EFFET NORMALEMENT OUVERT (SE/NO)

PVDF diaphragm valve, PVDF metric spigot outlets, equipped with failsafe normally open (NO) pneumatic actuator

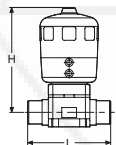

DIMENSIONS Dimensions					RÉFÉRENCE Product code			PN bar
d mm	DN mm	G inch	L mm	H mm	EPDM	FPM	PTFE	
20	15	1/2"	124	174	2208-00ZZE	2208-00ZZZ	2208-00ZZP	10
25	20	3/4"	143	174	2208-01ZZE	2208-01ZZZ	2208-01ZZP	10
32	25	1"	154	174	2208-02ZZE	2208-02ZZZ	2208-02ZZP	10
40	32	1"1/4	174	236	2208-03ZZE	2208-03ZZZ	2208-03ZZP	10
50	40	1"1/2	194	236	2208-04ZZE	2208-04ZZZ	2208-04ZZP	10
63	50	2"	224	283	2208-05ZZE	2208-05ZZZ	2208-05ZZP	10

ROBINET À MEMBRANE MOTORISÉ

Actuated diaphragm valve

SERIE 2209



N° Fiche produit - Product sheet
TDS-DIAPH-2300

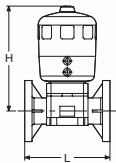

ROBINET PVDF À MEMBRANE À BRIDES, ÉQUIPÉ D'UN ACTIONNEUR PNEUMATIQUE SIMPLE EFFET NORMALEMENT FERMÉ (SE/NF)

Flanged PVDF diaphragm valve, equipped with failsafe normally closed (NC) pneumatic actuator

DIMENSIONS Dimensions					RÉFÉRENCE (BRIDES DIN*) Product code (DIN flanges*)			RÉFÉRENCE (BRIDES ANSI*) Product code (ANSI flanges*)			PN bar
d mm	DN mm	G inch	L mm	H mm	EPDM	FPM	PTFE	EPDM	FPM	PTFE	
20	15	1/2"	130	174	2209-00FFE	2209-00FFZ	2209-00FFP	2209-00GGE	2209-00GGZ	2209-00GGP	10
25	20	3/4"	150	174	2209-01FFE	2209-01FFZ	2209-01FFP	2209-01GGE	2209-01GGZ	2209-01GGP	10
32	25	1"	160	174	2209-02FFE	2209-02FFZ	2209-02FFP	2209-02GGE	2209-02GGZ	2209-02GGP	10
40	32	1"1/4	180	236	2209-03FFE	2209-03FFZ	2209-03FFP	2209-03GGE	2209-03GGZ	2209-03GGP	10
50	40	1"1/2	200	236	2209-04FFE	2209-04FFZ	2209-04FFP	2209-04GGE	2209-04GGZ	2209-04GGP	10
63	50	2"	230	283	2209-05FFE	2209-05FFZ	2209-05FFP	2209-05GGE	2209-05GGZ	2209-05GGP	10

* DIN = EN1092-1 PN10/16

ANSI = ASME B16.5 Class 150

ROBINET PVDF À MEMBRANE, DOUBLE UNION, EMBOUTS PVDF FEMELLES MÉTRIQUES, ÉQUIPÉ D'UN ACTIONNEUR PNEUMATIQUE SIMPLE EFFET NORMALEMENT FERMÉ (SE/NF)

PVDF diaphragm valve, double union, PVDF metric sockets, equipped with failsafe normally closed (NC) pneumatic actuator

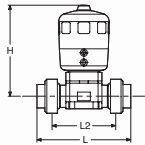

DIMENSIONS Dimensions						RÉFÉRENCE Product code			PN bar
d mm	DN mm	G inch	L mm	L2 mm	H mm	EPDM	FPM	PTFE	
20	15	1/2"	177	134	174	2209-00CCE	2209-00CCZ	2209-00CCP	10
25	20	3/4"	176	134	174	2209-01CCE	2209-01CCZ	2209-01CCP	10
32	25	1"	182	133	174	2209-02CCE	2209-02CCZ	2209-02CCP	10
40	32	1"1/4	217	165	236	2209-03CCE	2209-03CCZ	2209-03CCP	10
50	40	1"1/2	240	178	236	2209-04CCE	2209-04CCZ	2209-04CCP	10
63	50	2"	269	197	283	2209-05CCE	2209-05CCZ	2209-05CCP	10

ROBINET PVDF À MEMBRANE, SORTIES PVDF MÂLES, ÉQUIPÉ D'UN ACTIONNEUR PNEUMATIQUE SIMPLE EFFET NORMALEMENT FERMÉ (SE/NF)

PVDF diaphragm valve, PVDF metric spigot outlets, equipped with failsafe normally closed (NC) pneumatic actuator

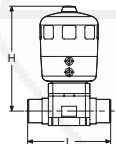

DIMENSIONS Dimensions					RÉFÉRENCE Product code			PN bar
d mm	DN mm	G inch	L mm	H mm	EPDM	FPM	PTFE	
20	15	1/2"	124	174	2209-00ZZE	2209-00ZZZ	2209-00ZZP	10
25	20	3/4"	143	174	2209-01ZZE	2209-01ZZZ	2209-01ZZP	10
32	25	1"	154	174	2209-02ZZE	2209-02ZZZ	2209-02ZZP	10
40	32	1"1/4	174	236	2209-03ZZE	2209-03ZZZ	2209-03ZZP	10
50	40	1"1/2	194	236	2209-04ZZE	2209-04ZZZ	2209-04ZZP	10
63	50	2"	224	283	2209-05ZZE	2209-05ZZZ	2209-05ZZP	10

quotes@tipes.co.uk

ROBINET À MEMBRANE MOTORISÉ

Actuated diaphragm valve

OPTIONS



N° Fiche produit - Product sheet
TDS-EQUIP-2300



BOITIER DE FIN DE COURSE AVEC 2 CONTACTS MÉCANIQUES POUR ROBINET À MEMBRANE AUTOMATIQUE (AVEC KIT D'ADAPTATION)

Limit switch box with 2 mechanical switches for actuated diaphragm valve (with mounting kit)

DIMENSIONS		RÉFÉRENCE	TENSION
Dimensions		Product code	Voltage
d	DN		
mm	mm		
20-32	15-25	B08FC-OF48	0-48V AC/DC
20-32	15-25	B08FC-250	50-250V AC/DC
40-63	32-50	B12FC-OF48	0-48V AC/DC
40-63	32-50	B12FC-250	50-250V AC/DC



BOITIER DE FIN DE COURSE AVEC 2 CONTACTS INDUCTIFS NAMUR 2 FILS (AVEC DIODE) POUR ROBINET À MEMBRANE AUTOMATIQUE (AVEC KIT D'ADAPTATION)

Limit switch box with 2 inductive switches NAMUR 2 wires (with diode) for actuated diaphragm valve (with mounting kit)

DIMENSIONS		RÉFÉRENCE	TENSION
Dimensions		Product code	Voltage
d	DN		
mm	mm		
20-32	15-25	B08FC-IPFOF	8.2V DC
40-63	32-50	B12FC-IPFOF	8.2V DC



BOITIER DE FIN DE COURSE AVEC 2 CONTACTS INDUCTIFS PNP 3 FILS (AVEC DIODE) POUR ROBINET À MEMBRANE AUTOMATIQUE (AVEC KIT D'ADAPTATION)

Limit switch box with 2 inductive switches PNP 3 wires (with diode) for actuated diaphragm valve (with mounting kit)

DIMENSIONS		RÉFÉRENCE	TENSION
Dimensions		Product code	Voltage
d	DN		
mm	mm		
20-32	15-25	B08FC-IBAOF	24V DC
40-63	32-50	B12FC-IBAOF	24V DC

Autres accessoires (électrovanne, filtre régulateur, ...) : merci de consulter les accessoires pour actionneurs pneumatiques quart de tour (page 186).

Other accessories (solenoid valve, filter regulator, ...) : please go to the «accessories for quarter-turn pneumatic actuators» section (page 186).

ROBINET À MEMBRANE MOTORISÉ

Actuated diaphragm valve

OPTIONS



N° Fiche produit - Product sheet
TDS-EQUIP-2300



LIMITEUR DE COURSE À L'OUVERTURE ET FERMETURE POUR ROBINET À MEMBRANE AUTOMATIQUE, AVEC INDICATEUR VISUEL DE POSITION

Upper and lower stroke limiter for actuated diaphragm valve, with visual position indicator

DIMENSIONS		RÉFÉRENCE
Dimensions		Product code
d	DN	
mm	mm	
20-32	15-25	B08LI-OF
40-63	32-50	B12LI-OF



VOLANT DE SECOURS POUR ROBINET À MEMBRANE AUTOMATIQUE, AVEC INDICATEUR VISUEL DE POSITION

Manual override for actuated diaphragm valve, with visual position indicator

DIMENSIONS		RÉFÉRENCE
Dimensions		Product code
d	DN	
mm	mm	
20-32	15-25	B08VO-SECOU
40-63	32-50	B12VO-SECOU



SYSTÈME DE POSITIONNEUR 4-20 MA AVEC TÉLÉCAPTEUR POUR ROBINET À MEMBRANE AUTOMATIQUE (*)

4-20 mA electro-pneumatic positioner with remote sensor for actuated diaphragm valve (*)

DIMENSIONS		RÉFÉRENCE	TYPE
Dimensions		Product code	Type
d	DN		
mm	mm		
20-32	15-25	B08PO-BAS1-SE	8791 BASIC
40-63	32-50	B12PO-BAS1-SE	8791 BASIC
20-32	15-25	B08PO-PID1-SE	8793 Process regulator
40-63	32-50	B12PO-PID1-SE	8793 Process regulator

* Montage et réglage en usine obligatoire. L'installation d'un filtre monodétendeur est conseillée

* Installation and setting must be done in SAFI's premises. Installation of a filter regulator is suggested



ADAPTATEUR NAMUR POUR ÉLECTRO-DISTRIBUTEUR

NAMUR adapter for electro-distributor

DIMENSIONS		RÉFÉRENCE
Dimensions		Product code
d	DN	
mm	mm	
20-50	15-40	B10NA-ENS
63	50	B12NA-ENS

Autres accessoires (électrovanne, filtre régulateur, ...) : merci de consulter les accessoires pour actionneurs pneumatiques quart de tour (page 186).

Other accessories (solenoid valve, filter regulator, ...) : please go to the «accessories for quarter-turn pneumatic actuators» section (page 186).

ACTIONNEUR PNEUMATIQUE 1/4 TOUR

1/4 turn pneumatic actuator

SERIE UT-MT



N° Fiche produit - Product sheet
TDS-ACTPN-0001

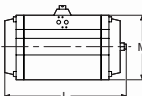

ACTIONNEUR PNEUMATIQUE TYPE UT-MT DOUBLE EFFET (DE) POUR ROBINET 1/4 DE TOUR

Double acting (DA) pneumatic actuator type UT-MT for 1/4 turn valve

DIMENSIONS		RÉFÉRENCE Product code	TYPE Type	MATIÈRE DU CORPS Casing material	CONNEXION ISO 5211 ISO 5211 connection	COUPLE À 5.62 BAR Torque @ 5.62 bar
L	M					
mm	mm					N.m
119	70	2007-73A	UT10	Polyamide	F03-F04 / 11	14.1
160	90	2007-73B	UT13	Polyamide	F04**F05-F07 / 14	30.9
175	111.5	2007-73C	UT18	Polyamide	F04**F05-F07 / 17	56.5
119	71	2007-83A	MT05	Aluminium	F03-F05 / 11	14.1
175	81	2007-83C	MT15	Aluminium	F04**F05-F07 / 14	30.9
186	98	2007-83D	MT20	Aluminium	F05-F07 / 17	56.5
248	98	2007-83E	MT25	Aluminium	F05-F07 / 17	84.5
241	117	2007-83F	MT30	Aluminium	F05-F07 / 17	112.7
261	154	2007-83G	MT35	Aluminium	F07-F10 / 22	180.4
305	154	2007-83H	MT40	Aluminium	F07-F10 / 22	225.7
367	168.5	2007-83I	MT45	Aluminium	F07-F10 / 22	352.7
428	202	2007-83K	MT55	Aluminium	F10-F12 / 27	676.4
467	257	2007-83L	MT60	Aluminium	F10-F14 / 36	1029.6
525	257	2007-83M	MT65	Aluminium	F10-F14 / 36	1357.8
636	328	2007-83N	MT70	Aluminium	F14-F16 / 46	2658.0

**F04 = sur demande
**F04 = on request

Autres matières ou couples, nous consulter.
Please contact us for other casing materials or torques.

quotes@tfpes.co.uk

ACTIONNEUR PNEUMATIQUE 1/4 TOUR

1/4 turn pneumatic actuator

SERIE UT-MT



N° Fiche produit - Product sheet
TDS-ACTPN-0001

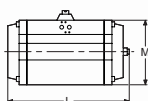

ACTIONNEUR PNEUMATIQUE TYPE UT-MT SIMPLE EFFET (SE) POUR ROBINET 1/4 DE TOUR

Failsafe pneumatic actuator type UT-MT for 1/4 turn valve

DIMENSIONS		RÉFÉRENCE		TYPE	MATIÈRE DU CORPS	CONNEXION ISO 5211	COUPLE SUR RESSORT	COUPLE D'OUVERTURE @ 5.62 BAR
Dimensions		Product code		Type	Casing material	ISO 5211 connection	Springs torque	Opening torque @ 5.62 bar
L	M	NF	NO				Début - Fin	Début - Fin
mm	mm	Failsafe closed	Failsafe open				N.m	N.m
119	70	2007-73T	2007-75T	UT10-SR2	Polyamide	F03-F04 / 11	7.4 - 5.0	9.1 - 6.7
160	90	2007-73M	2007-75M	UT13-SR4	Polyamide	F04**-F05-F07 / 14	17.1 - 12.5	18.4 - 13.8
175	111.5	2007-73N	2007-75N	UT18-SR4	Polyamide	F04**-F05-F07 / 17	28.4 - 21.6	34.9 - 28.1
119	71	2007-84A	2007-85A	MT05-SR2	Aluminium	F03-F05 / 11	7.4 - 5.0	9.1 - 6.7
175	81	2007-84C	2007-85C	MT15-SR4	Aluminium	F04**-F05-F07 / 14	16.9 - 12.1	18.8 - 14.0
186	98	2007-84D	2007-85D	MT20-SR4	Aluminium	F05-F07 / 17	27.7 - 20.8	35.7 - 28.8
248	98	2007-84E	2007-85E	MT25-SR5	Aluminium	F05-F07 / 17	55.3 - 34.9	49.6 - 29.2
241	117	2007-84F	2007-85F	MT30-SR4	Aluminium	F05-F07 / 17	56.6 - 42.2	70.5 - 56.1
261	154	2007-84G	2007-85G	MT35-SR4	Aluminium	F07-F10 / 22	93 - 69.3	111.1 - 87.4
305	154	2007-84H	2007-85H	MT40-SR4	Aluminium	F07-F10 / 22	114.1 - 83.7	142.0 - 111.6
367	168.5	2007-84I	2007-85I	MT45-SR4	Aluminium	F07-F10 / 22	200.8 - 126.2	226.5 - 151.9
380.5	202	2007-84J	2007-85J	MT50-SR4	Aluminium	F10-F12 / 27	248.6 - 196.2	313.0 - 260.6
428	202	2007-84K	2007-85K	MT55-SR5	Aluminium	F10-F12 / 27	419.7 - 297.8	378.6 - 256.7
467	257	2007-84L	2007-85L	MT60-SR5	Aluminium	F10-F14 / 36	605.6 - 482.7	546.9 - 424.0
525	257	2007-84M	2007-85M	MT65-SR5	Aluminium	F10-F14 / 36	792.8 - 588.1	769.7 - 565.0
636	328	2007-84N	2007-85N	MT70-SR6	Aluminium	F14-F16 / 46	1438.0 - 1039.0	1619.0 - 1220.0
734	328	2007-84O	2007-85O	MT75-SR6	Aluminium	F16 / 46	1925.0 - 1208.0	2356.0 - 1639.2

**F04 = sur demande
**F04 = on request

Autres matières ou couples, nous consulter.
Please contact us for other casing materials or torques.

quotes@tipes.co.uk

ACTIONNEUR PNEUMATIQUE 1/4 TOUR

1/4 turn pneumatic actuator

OPTIONS UT-MT



N° Fiche produit - Product sheet
TDS-ACTPN-0002



BOITIER DE FIN DE COURSE IP67 EN ALUMINIUM POUR ACTIONNEUR PNEUMATIQUE TYPE UT-MT

Aluminium limit switch box (IP67) for pneumatic actuator type UT-MT

RÉFÉRENCE Product code	TYPE Type	CONTACTS Switches	DÉSIGNATION Description
2007-73Z0	BE45-220M03	Mécaniques Mechanical	SPDT 3A@250 VAC - 4A @ 30 VDC
2007-74CB	BS45-220MB3	Inductifs Inductive	10-36 VDC NO PNP IFM mod IS5001 (3 wires)
2007-74DD	BS45-220MD3	Inductifs Inductive	5-36 VDC IFM mod IS5026 (2 wires)
2007-74EF	BS45-220MF3	Inductifs Inductive	P&F EExia mod NJ2-V3-N ATEX II 2 G D



BOITIER DE FIN DE COURSE IP67 EN ALUMINIUM EXPLOSION PROOF EEXD IIC T6 POUR ACTIONNEUR PNEUMATIQUE TYPE UT-MT

Aluminium limit switch box (IP67) EXPLOSION PROOF EEXD IIC T6 for pneumatic actuator type UT-MT

RÉFÉRENCE Product code	TYPE Type	CONTACTS Switches	DÉSIGNATION Description
2007-74W0	BE48-220M03	Mécaniques Mechanical	SPDT 3A@250 VAC - 4A @ 30 VDC
2007-74MB	BS48-220MB3	Inductifs Inductive	10-36 VDC NO PNP IFM mod IS5001 (3 wires)
2007-74RD	BS48-220MD3	Inductifs Inductive	5-36 VDC IFM mod IS5026 (2 wires)
2007-76DF	BS48-220MF3	Inductifs Inductive	P&F EExia mod NJ2-V3-N ATEX II 2 G D



POSITIONNEUR ÉLECTROPNEUMATIQUE 4-20 MA POUR ACTIONNEUR PNEUMATIQUE TYPE UT-MT (*)

4-20 mA electro-pneumatic positioner for pneumatic actuator type UT-MT(*)

RÉFÉRENCE Product code	TYPE Type	DÉSIGNATION Description
2007-74Q	PEY01	Standard
2007-74V	PEY04	Avec 2 contacts mécaniques SPDT With 2 internal switches SPDT

* Montage et réglage en usine obligatoire. L'installation d'un filtre manodétendeur est conseillée
* Installation and setting must be done in SAFI's premises. Installation of a filter regulator is suggested

Nombreuses autres options, n'hésitez pas à nous consulter.
Many other options are available, do not hesitate to contact us.

ACTIONNEUR PNEUMATIQUE 1/4 TOUR

1/4 turn pneumatic actuator

OPTIONS



N° Fiche produit - Product sheet
TDS-EQUIP-0008



ELECTROVANNE 3/2 NF EN LAITON AVEC BOBINE ET CONNECTEUR

Solenoid valve 3/2 NC in brass with coil and connector

RÉFÉRENCE Product code	TYPE Type	BOBINE Coil
2007-53AB	131B04-496131C2	24V DC
2007-53AC	131B04-496131P0	24V AC
2007-53AD	131B04-496131S4	48V AC
2007-53AE	131B04-496131P2	115V AC
2007-53AF	131B04-496131P9	230V AC
2007-53AG	131B04-496131C4	48V DC



ELECTRODISTRIBUTEUR MONOSTABLE 3/2 NF - 5/2 NAMUR AVEC BOBINE ET CONNECTEUR

Electrodistributor mono-stable 3/2 NC - 5/2 NAMUR with coil and connector

RÉFÉRENCE Product code	TYPE Type	BOBINE Coil
2007-53XB	341N05-496131C2	24V DC
2007-53XC	341N05-496131P0	24V AC
2007-53XD	341N05-496131S4	48V AC
2007-53XE	341N05-496131P2	115V AC
2007-53XF	341N05-496131P9	230V AC
2007-53XG	341N05-496131C4	48V DC



FILTRE RÉGULATEUR 1/4" EN POLYCARBONATE

Filter regulator 1/4" with polycarbonate bowl

RÉFÉRENCE Product code	TYPE Type	DÉSIGNATION Description
2007-58X	FRL1G14	Filtre régulateur 1/4" en polycarbonate Filter regulator 1/4" with polycarbonate bowl

Nombreuses autres options, n'hésitez pas à nous consulter.
Many other options are available, do not hesitate to contact us.

quotes@tipes.co.uk

ACTIONNEUR PNEUMATIQUE 1/4 TOUR

1/4 turn pneumatic actuator

OPTIONS



N° Fiche produit - Product sheet
TDS-EQUIP-0008



SILENCIEUX ET LIMITEURS D'ÉCHAPPEMENT POUR ÉLECTRODISTRIBUTEUR

Brass silencer and speed regulator for electro distributor

RÉFÉRENCE Product code	TYPE Type	FONCTION Function	DIMENSIONS Dimensions
2007-58S	MV110014	Silencieux Silencer	1/4"
2007-58R	MV110018	Silencieux Silencer	1/8"
2007-53U	MV11VE0014	Silencieux et limiteur Silencer and speed regulator	1/4"
2007-58W	MV11VE0018	Silencieux et limiteur Silencer and speed regulator	1/8"

Nombreuses autres options, n'hésitez pas à nous consulter.
Many other options are available, do not hesitate to contact us.

quotes@tfpes.co.uk

ACTIONNEUR ÉLECTRIQUE

Electric actuator

ELECTRIC



N° Fiche produit - Product sheet
TDS-ACTEL-0001



version ER



Version VS



Version VT1000



Version VT1500



version ER



Version VS

ACTIONNEUR ÉLECTRIQUE STANDARD POUR ROBINET 1/4 DE TOUR

Standard electric actuator for 1/4 turn valve

RÉFÉRENCE		TYPE	CONNEXION ISO 5211	COUPLE NOMINAL	TEMPS DE MANŒUVRE 90°	PROTECTION IP
Product code		Type	ISO 5211 connection	Operating torque	Operating time 90°	IP protection
100-240 VAC 100-350 VDC	15-30 VAC 12-48 VDC			N.m	s	
2907-39A	2907-39B	ER10	F03-F04-F05 / 14	10.0	11.0	66
2907-40C	2907-40A	ER20	F05 / 14	20.0	12.0	66
2907-41R	2907-41N	ER35	F05-F07 / 22	35.0	7.0	66
2907-43B	2907-43F	ER60	F05-F07 / 22	60.0	12.0	66
2907-49B	2907-49D	ER100	F05-F07 / 22	100.0	23.0	66
2907-46A	2907-46C	VS150	F07-F10 / 22	125.0	30.0	68
2907-47A	2907-47C	VS300	F07-F10 / 22	250.0	60.0	68
2907-48A		VT600	F10-F12 / 36	450.0	38.0	68
2907-51A		VT1000	F10-F12 / 36	750.0	38.0	68
2907-52A		VT1500	F12-F16 / 46	1200.0	113.0	68

Encombrements : Voir fiche produit.
Overall dimensions: See product sheet.

Version 400V triphasé : nous consulter.
400V 3 phases: please contact us.

ACTIONNEUR ÉLECTRIQUE FAILSAFE (NF) POUR ROBINET 1/4 DE TOUR

FAILSAFE (NC) electric actuator for 1/4 turn valve

RÉFÉRENCE		TYPE	CONNEXION ISO 5211	COUPLE NOMINAL	TEMPS DE MANŒUVRE 90°	PROTECTION IP
Product code		Type	ISO 5211 connection	Operating torque	Operating time 90°	IP protection
100-240 VAC 100-350 VDC	15-30 VAC 12-48 VDC			N.m	s	
2907-39E	2907-39F	ER10	F03-F04-F05 / 14	10.0	11.0	66
2907-40F	2907-40D	ER20	F05 / 14	20.0	12.0	66
2907-41M	2907-41P	ER35	F05-F07 / 22	35.0	7.0	66
2907-43N	2907-43M	ER60	F05-F07 / 22	60.0	12.0	66
2907-49H	2907-49G	ER100	F05-F07 / 22	100.0	23.0	66
2907-46B	2907-46E	VS150	F07-F10 / 22	125.0	30.0	68
2907-47F	2907-47D	VS300	F07-F10 / 22	250.0	60.0	68

Encombrements : Voir fiche produit.
Overall dimensions: See product sheet.

Nombreuses options disponibles, consultez-nous.
Many options available, please contact us.

ACTIONNEUR ÉLECTRIQUE

Electric actuator

ELECTRIC



N° Fiche produit - Product sheet
TDS-ACTEL-0001



version ER



Version VS

ACTIONNEUR ÉLECTRIQUE POUR ROBINET 1/4 DE TOUR AVEC POSITIONNEUR 4-20 MA INTÉGRÉ

Electric actuator for 1/4 turn valve with 4-20 mA positioner

RÉFÉRENCE		TYPE	CONNEXION ISO 5211	COUPLE NOMINAL	TEMPS DE MANŒUVRE 90°	PROTECTION IP
Product code		Type	ISO 5211 connection	Operating torque	Operating time 90°	IP protection
100-240 VAC	15-30 VAC			N.m	s	
100-350 VDC	12-48 VDC					
2907-40Q	2907-40R	ER20	F03-F04-F05 / 14	20.0	25.0	66
2907-41J	2907-41Q	ER35	F05-F07 / 22	35.0	41.0	66
2907-43D	2907-43J	ER60	F05-F07 / 22	60.0	79.0	66
2907-49I	2907-49E	ER100	F05-F07 / 22	100.0	119.0	66
2907-46G	2907-46F	VS150	F07-F10 / 22	125.0	30.0	68
2907-47G	2907-47E	VS300	F07-F10 / 22	250.0	60.0	68

Encombrements : Voir fiche produit.
Overall dimensions: See product sheet.

Positionneur 0-10V disponible sur demande.
Nombreuses options disponibles, consultez-nous.

0-10V positioner available on demand.
Many options available, please contact us.

quotes@tfpses.co.uk

quotes@tipes.co.uk

GUIDE

Tel: 01626 201092

190

www.safi-valves.com



GUIDE DE MOTORISATION - Actuation guide

GUIDE DE MOTORISATION - Actuation guide

Les tableaux suivants donnent, pour chaque type et DN de robinet, la référence du kit de motorisation et des actionneurs adaptés.

Il convient de rechercher la référence du robinet souhaité dans la page correspondante du catalogue, puis de trouver dans l'un des tableaux ci-après la référence de l'actionneur souhaité et du kit de motorisation correspondant.

Par exemple, pour commander un robinet PVC-U à tournant sphérique 2 voies, d63/DN50, double union, embouts PVC-U femelles métriques, la page 26 du catalogue donne la référence : 3101-05BBE.

Si l'on souhaite le motoriser avec un actionneur pneumatique simple effet normalement fermé, le 1er tableau ci-après donne :

3101-05BBE + KIT0067 + 2007-73N

The following tables give, for every type and diameter of valve, the codes of the actuation kit and possible actuators.

You need to find the code of the requested valve in the corresponding page of the catalogue, then to find the code of the actuation kit and actuator in one of the tables hereafter.

For example, to order a 2-way PVC-U ball valve, d63/DN50, double union with PVC-U metric sockets, the page 26 gives the code of the valve : 3101-05BBE.

If you wish to actuate it with a failsafe normally closed actuator, the first table hereafter gives :

3101-05BBE + KIT0067 + 2007-73N

SERIE 3101 - 3111 - 3150

MOTORISATION DES ROBINETS À TOURNANT SPHÉRIQUE 2 VOIES, DOUBLE UNION, SÉRIES 3150 (PP-H), 3101 (PVC-U), 3111 (PVC-C)
Actuation of 2-way double union ball valve, series 3150 (PP-H), 3101 (PVC-U), 3111 (PVC-C)

MOTORISATION PNEUMATIQUE

Pneumatic actuation

DIMENSIONS Dimensions			Couple du robinet pour motorisation Valve torque for actuation	RÉFÉRENCE DOUBLE EFFET Product code double acting		RÉFÉRENCE SIMPLE EFFET Product code failsafe		
d	DN		N.m	Kit DE	Actionneur DE	Kit SE	Actionneur NF	Actionneur NO
mm	mm	inch.		DA Kit	DA Actuator	Failsafe Kit	NC Actuator	NO Actuator
20	15	1/2"	4,0	KIT0060	2007-73A	KIT0060	2007-73T	2007-75T
25	20	3/4"	4,0	KIT0051	2007-73A	KIT0051	2007-73T	2007-75T
32	25	1"	10,6	KIT0052	2007-73A	KIT0063	2007-73M	2007-75M
40	32	1"1/4	10,6	KIT0064	2007-73B	KIT0064	2007-73M	2007-75M
50	40	1"1/2	10,6	KIT0064	2007-73B	KIT0064	2007-73M	2007-75M
63	50	2"	20,0	KIT0066	2007-73B	KIT0067	2007-73N	2007-75N
75	65	2"1/2	50,0	KIT0068	2007-73C	KIT0069	2007-84G	2007-85G
90	80	3"	70,0	KIT0070	2007-83E	KIT0071	2007-84G	2007-85G
110	100	4"	70,0	KIT0072	2007-83G	KIT0072	2007-84G	2007-85G

DE = Double Effet

SE = Simple Effet

NF = Normalement Fermé

NO = Normalement Ouvert

DA = Double Acting

SE = Single Acting

NC = Normally Closed

NO = Normally Open

MOTORISATION ÉLECTRIQUE

Electric actuation

DIMENSIONS Dimensions			Couple du robinet pour motorisation Valve torque for actuation	RÉFÉRENCE Product code						
d	DN		N.m	Kit	Moteur standard	Moteur standard	Moteur failsafe (NF)	Moteur failsafe (NF)	Moteur posi	Moteur posi
mm	mm	inch.		Kit	100-240VAC / 100-350 VDC	15-30VAC / 12-48 VDC	100-240VAC / 100-350 VDC	15-30VAC / 12-48 VDC	100-240VAC / 100-350 VDC	15-30VAC / 12-48 VDC
20	15	1/2"	4,0	KIT0061	2907-39A	2907-39B	2907-39E	2907-39F	2907-40Q	2907-40R
25	20	3/4"	4,0	KIT0062	2907-39A	2907-39B	2907-39E	2907-39F	2907-40Q	2907-40R
32	25	1"	10,6	KIT0063	2907-40C	2907-40A	2907-40F	2907-40D	2907-40Q	2907-40R
40	32	1"1/4	10,6	KIT0064	2907-40C	2907-40A	2907-40F	2907-40D	2907-40Q	2907-40R
50	40	1"1/2	10,6	KIT0064	2907-40C	2907-40A	2907-40F	2907-40D	2907-40Q	2907-40R
63	50	2"	20,0	KIT0066	2907-40C	2907-40A	2907-40F	2907-40D	2907-40Q	2907-40R
75	65	2"1/2	50,0	KIT0069	2907-43B	2907-43F	2907-43N	2907-43M	2907-43D	2907-43J
90	80	3"	70,0	KIT0071	2907-49B	2907-49D	2907-49H	2907-49G	2907-49I	2907-49E
110	100	4"	70,0	KIT0072	2907-49B	2907-49D	2907-49H	2907-49G	2907-49I	2907-49E

Notes : - Le dimensionnement des actionneurs pneumatiques a été effectué avec une pression d'air de 5.62 bar. Pour d'autres pressions, veuillez nous consulter.
- Le «couple du robinet pour motorisation» est le couple nécessaire pour ouvrir le robinet lorsque dP=PN et tenant compte d'une marge de sécurité.

- The sizing of pneumatic actuators was done with an air pressure of 5.62 bar. For other pressures, please contact us.
- The «valve torque for actuation» is the required torque to open the valve when dP=PN and including a safety coefficient

Tel: 01626 201092

www.safi-valves.com

Série 2008 - 2014 - 2091 - (1003-27/28)

MOTORISATION DES ROBINETS À TOURNANT SPHÉRIQUE 2 VOIES, COMPACT ET SANDWICHES À BRIDES, SÉRIES 2014 (PPGF), 2091 (PP-EL), 1003-27/28 (PPGF), 2008-09 (PPGF)

Actuation of 2-way flanged ball valve, series 2014 (PPGF), 2091 (PP-EL), 1003-27/28 (PPGF), 2008-09 (PPGF)

MOTORISATION PNEUMATIQUE

Pneumatic actuation

DIMENSIONS Dimensions			Couple du robinet pour motorisation Valve torque for actuation	RÉFÉRENCE DOUBLE EFFET Product code double acting		RÉFÉRENCE SIMPLE EFFET Product code failsafe		
d	DN		N.m	Kit DE	Actionneur DE	Kit SE	Actionneur NF	Actionneur NO
mm	mm	inch.		DA Kit	DA Actuator	Failsafe Kit	NC Actuator	NO Actuator
20	15	1/2"	10,0	KIT0130	2007-73A	KIT0131	2007-73M	2007-75M
25	20	3/4"	10,0	KIT0130	2007-73A	KIT0131	2007-73M	2007-75M
32	25	1"	10,0	KIT0171	2007-73A	KIT0133	2007-73M	2007-75M
40	32	1"1/4	10,0	KIT0171	2007-73A	KIT0133	2007-73M	2007-75M
50	40	1"1/2	10,0	KIT0172	2007-73A	KIT0136	2007-73M	2007-75M
63	50	2"	14,0	KIT0172	2007-73A	KIT0137	2007-73N	2007-75N
90	80	3"	40,0	KIT0020	2007-73C	KIT0020	2007-84F	2007-85F
110	100	4"	40,0	KIT0020	2007-73C	KIT0020	2007-84F	2007-85F
160	150	6"	120,0	KIT0152	2007-83F	KIT0154	2007-84I	2007-85I

DE = Double Effet

SE = Simple Effet

NF = Normalement Fermé

NO = Normalement Ouvert

DA = Double Acting

SE = Single Acting

NC = Normally Closed

NO = Normally Open

MOTORISATION ÉLECTRIQUE

Electric actuation

DIMENSIONS Dimensions			Couple du robinet pour motorisation Valve torque for actuation	RÉFÉRENCE Product code						
d	DN		N.m	Kit	Moteur standard	Moteur standard	Moteur failsafe (NF)	Moteur failsafe (NF)	Moteur posi	Moteur posi
mm	mm	inch.		Kit	100-240VAC / 100-350 VDC	15-30VAC / 12-48 VDC	100-240VAC / 100-350 VDC	15-30VAC / 12-48 VDC	100-240VAC / 100-350 VDC	15-30VAC / 12-48 VDC
20	15	1/2"	10,0	KIT0131	2907-39A	2907-39B	2907-39E	2907-39F	2907-40Q	2907-40R
25	20	3/4"	10,0	KIT0131	2907-39A	2907-39B	2907-39E	2907-39F	2907-40Q	2907-40R
32	25	1"	10,0	KIT0133	2907-39A	2907-39B	2907-39E	2907-39F	2907-40Q	2907-40R
40	32	1"1/4	10,0	KIT0133	2907-39A	2907-39B	2907-39E	2907-39F	2907-40Q	2907-40R
50	40	1"1/2	10,0	KIT0136	2907-39A	2907-39B	2907-39E	2907-39F	2907-40Q	2907-40R
63	50	2"	14,0	KIT0136	2907-40C	2907-40A	2907-40F	2907-40D	2907-40Q	2907-40R
90	80	3"	40,0	KIT0022	2907-43B	2907-43F	2907-43N	2907-43M	2907-43D	2907-43J
110	100	4"	40,0	KIT0022	2907-43B	2907-43F	2907-43N	2907-43M	2907-43D	2907-43J
160	150	6"	120,0	KIT0154	2907-46A	2907-46C	2907-46B	2907-46E	2907-46G	2907-46F

Notes : - Le dimensionnement des actionneurs pneumatiques a été effectué avec une pression d'air de 5.62 bar. Pour d'autres pressions, veuillez nous consulter.
- Le «couple du robinet pour motorisation» est le couple nécessaire pour ouvrir le robinet lorsque dP=PN et tenant compte d'une marge de sécurité.

- The sizing of pneumatic actuators was done with an air pressure of 5.62 bar. For other pressures, please contact us.
- The «valve torque for actuation» is the required torque to open the valve when dP=PN and including a safety coefficient

Tel: 01626 201092

193

www.safi-valves.com

SERIE 2029 - (2027-17/18)

MOTORISATION DES ROBINETS À TOURNANT SPHÉRIQUE 2 VOIES, COMPACT ET SANDWICHES À BRIDES,
SÉRIES 2029 (PVDF), 2027-17/18 (PVDF)

Actuation of 2-way flanged ball valve, series 2029 (PVDF), 2027-17/18 (PVDF)

MOTORISATION PNEUMATIQUE

Pneumatic actuation

DIMENSIONS Dimensions			Couple du robinet pour motorisation Valve torque for actuation	RÉFÉRENCE DOUBLE EFFET Product code double acting		RÉFÉRENCE SIMPLE EFFET Product code failsafe		
d	DN		N.m	Kit DE	Actionneur DE	Kit SE	Actionneur NF	Actionneur NO
mm	mm	inch.		DA Kit	DA Actuator	Failsafe Kit	NC Actuator	NO Actuator
20	15	1/2"	8,0	KIT0130	2007-73A	KIT0131	2007-73M	2007-75M
25	20	3/4"	8,0	KIT0130	2007-73A	KIT0131	2007-73M	2007-75M
32	25	1"	10,0	KIT0171	2007-73A	KIT0133	2007-73M	2007-75M
40	32	1"1/4	10,0	KIT0171	2007-73A	KIT0133	2007-73M	2007-75M
50	40	1"1/2	10,0	KIT0172	2007-73A	KIT0136	2007-73M	2007-75M
63	50	2"	16,0	KIT0136	2007-73B	KIT0137	2007-73N	2007-75N
90	80	3"	40,0	KIT0020	2007-73C	KIT0020	2007-84F	2007-85F
110	100	4"	60,0	KIT0020	2007-73C	KIT0153	2007-84G	2007-85G
160	150	6"	100,0	KIT0152	2007-83F	KIT0154	2007-84I	2007-85I

DE = Double Effet

SE = Simple Effet

NF = Normalement Fermé

NO = Normalement Ouvert

DA = Double Acting

SE = Single Acting

NC = Normally Closed

NO = Normally Open

MOTORISATION ÉLECTRIQUE

Electric actuation

DIMENSIONS Dimensions			Couple du robinet pour motorisation Valve torque for actuation	RÉFÉRENCE Product code						
d	DN		N.m	Kit	Moteur standard	Moteur standard	Moteur failsafe (NF)	Moteur failsafe (NF)	Moteur posi	Moteur posi
mm	mm	inch.		Kit	100-240VAC / 100-350 VDC	15-30VAC / 12-48 VDC	100-240VAC / 100-350 VDC	15-30VAC / 12-48 VDC	100-240VAC / 100-350 VDC	15-30VAC / 12-48 VDC
20	15	1/2"	8,0	KIT0131	2907-39A	2907-39B	2907-39E	2907-39F	2907-40Q	2907-40R
25	20	3/4"	8,0	KIT0131	2907-39A	2907-39B	2907-39E	2907-39F	2907-40Q	2907-40R
32	25	1"	10,0	KIT0133	2907-39A	2907-39B	2907-39E	2907-39F	2907-40Q	2907-40R
40	32	1"1/4	10,0	KIT0133	2907-39A	2907-39B	2907-39E	2907-39F	2907-40Q	2907-40R
50	40	1"1/2	10,0	KIT0136	2907-39A	2907-39B	2907-39E	2907-39F	2907-40Q	2907-40R
63	50	2"	16,0	KIT0136	2907-40C	2907-40A	2907-40F	2907-40D	2907-40Q	2907-40R
90	80	3"	40,0	KIT0022	2907-43B	2907-43F	2907-43N	2907-43M	2907-43D	2907-43J
110	100	4"	60,0	KIT0022	2907-43B	2907-43F	2907-43N	2907-43M	2907-43D	2907-43J
160	150	6"	100,0	KIT0154	2907-46A	2907-46C	2907-46B	2907-46E	2907-46G	2907-46F

Notes : - Le dimensionnement des actionneurs pneumatiques a été effectué avec une pression d'air de 5.62 bar. Pour d'autres pressions, veuillez nous consulter.
- Le «couple du robinet pour motorisation» est le couple nécessaire pour ouvrir le robinet lorsque dP=PN et tenant compte d'une marge de sécurité.

- The sizing of pneumatic actuators was done with an air pressure of 5.62 bar. For other pressures, please contact us.
- The «valve torque for actuation» is the required torque to open the valve when dP=PN and including a safety coefficient

Tel: 01626 201092

194

www.safi-valves.com

SERIE 3600 - 3610 - 3700 - 3800

MOTORISATION DES ROBINETS À PAPILLON, SÉRIES 3600 (PVC-U), 3610 (PVC-C), 3700 (PP-H), 3800 (PVDF)
Actuation of butterfly valves, series 3600 (PVC-U), 3610 (PVC-C), 3700 (PP-H), 3800 (PVDF)

MOTORISATION PNEUMATIQUE

Pneumatic actuation

DIMENSIONS Dimensions			Couple du robinet pour motorisation Valve torque for actuation	RÉFÉRENCE DOUBLE EFFET Product code double acting		RÉFÉRENCE SIMPLE EFFET Product code failsafe		
d	DN			Kit DE	Actionneur DE	Kit SE	Actionneur NF	Actionneur NO
mm	mm	inch.	N.m	DA Kit	DA Actuator	Failsafe Kit	NC Actuator	NO Actuator
63	50	2"	30,0	KIT0023	2007-73B	KIT0144	2007-84E	2007-85E
75	65	2"1/2	30,0	KIT0023	2007-73B	KIT0144	2007-84E	2007-85E
90	80	3"	50,0	KIT0162	2007-73C	KIT0164	2007-84G	2007-85G
110	100	4"	110,0	KIT0005	2007-83F	KIT0165	2007-84I	2007-85I
140	125	5"	110,0	KIT0039	2007-83F	KIT0017	2007-84I	2007-85I
160	150	6"	170,0	KIT0083	2007-83G	KIT0148	2007-84J	2007-85J
225	200	8"	360,0	KIT0038	2007-83I	KIT0166	2007-84L	2007-85L
280	250	10"	660,0	KIT0163	2007-83K	KIT0141	2007-84N	2007-85N
315	300	12"	900,0	KIT0032	2007-83L	KIT0140	2007-84N	2007-85N
355	350	14"	1200,0	KIT0032	2007-83M	KIT0140	2007-84O	2007-85O
400	400	16"	1200,0	KIT0142	2007-83M	KIT0167	2007-84O	2007-85O

DE = Double Effet
SE = Simple Effet
NF = Normalement Fermé
NO = Normalement Ouvert

DA = Double Acting
SE = Single Acting
NC = Normally Closed
NO = Normally Open

MOTORISATION ÉLECTRIQUE

Electric actuation

DIMENSIONS Dimensions			Couple du robinet pour motorisation Valve torque for actuation	RÉFÉRENCE Product code						
d	DN			Kit	Moteur standard	Moteur standard	Moteur failsafe (NF)	Moteur failsafe (NF)	Moteur posi	Moteur posi
mm	mm	inch.	N.m	Kit	100-240VAC / 100-350 VDC	15-30VAC / 12-48 VDC	100-240VAC / 100-350 VDC	15-30VAC / 12-48 VDC	100-240VAC / 100-350 VDC	15-30VAC / 12-48 VDC
63	50	2"	30,0	KIT0181	2907-43B	2907-43F	2907-43N	2907-43M	2907-43D	2907-43J
75	65	2"1/2	30,0	KIT0181	2907-43B	2907-43F	2907-43N	2907-43M	2907-43D	2907-43J
90	80	3"	50,0	KIT0164	2907-43B	2907-43F	2907-43N	2907-43M	2907-43D	2907-43J
110	100	4"	110,0	KIT0165	2907-46A	2907-46C	2907-46B	2907-46E	2907-46G	2907-46F
140	125	5"	110,0	KIT0017	2907-46A	2907-46C	2907-46B	2907-46E	2907-46G	2907-46F
160	150	6"	170,0	KIT0083	2907-47A	2907-47C	2907-47F	2907-47D	2907-47G	2907-47E
225	200	8"	360,0	KIT0166	2907-48A	-	-	-	-	-
280	250	10"	660,0	KIT0182	2907-51A	-	-	-	-	-
315	300	12"	900,0	KIT0140	2907-52A	-	-	-	-	-
355	350	14"	1200,0	KIT0140	2907-52A	-	-	-	-	-
400	400	16"	1200,0	KIT0167	2907-52A	-	-	-	-	-

Notes :
- Le dimensionnement des actionneurs pneumatiques a été effectué avec une pression d'air de 5.62 bar. Pour d'autres pressions, veuillez nous consulter.
- Le «couple du robinet pour motorisation» est le couple nécessaire pour ouvrir le robinet lorsque dP=PN et tenant compte d'une marge de sécurité.

- The sizing of pneumatic actuators was done with an air pressure of 5.62 bar. For other pressures, please contact us.
- The «valve torque for actuation» is the required torque to open the valve when dP=PN and including a safety coefficient

Tel: 01626 201092

195

www.safi-valves.com

SERIE 1003

MOTORISATION DES ROBINETS À TOURNANT SPHÉRIQUE 2 VOIES, DOUBLE UNION, SÉRIE 1003 (PPGF)
Actuation of 2-way double union ball valve, serie 1003 (PPGF)

MOTORISATION PNEUMATIQUE

Pneumatic actuation

DIMENSIONS Dimensions			Couple du robinet pour motorisation Valve torque for actuation	RÉFÉRENCE DOUBLE EFFET Product code double acting		RÉFÉRENCE SIMPLE EFFET Product code failsafe		
d	DN			Kit DE	Actionneur DE	Kit SE	Actionneur NF	Actionneur NO
mm	mm	inch.	N.m	DA Kit	DA Actuator	Failsafe Kit	NC Actuator	NO Actuator
20	15	1/2"	8,0	KIT0130	2007-73A	KIT0131	2007-73M	2007-75M
25	20	3/4"	8,0	KIT0130	2007-73A	KIT0131	2007-73M	2007-75M
32	25	1"	8,0	KIT0173	2007-73B	KIT0173	2007-73M	2007-75M
40	32	1"1/4	8,0	KIT0173	2007-73B	KIT0173	2007-73M	2007-75M
50	40	1"1/2	8,0	KIT0176	2007-73B	KIT0176	2007-73M	2007-75M
63	50	2"	8,0	KIT0176	2007-73B	KIT0176	2007-73M	2007-75M

DE = Double Effet
SE = Simple Effet
NF = Normalement Fermé
NO = Normalement Ouvert

DA = Double Acting
SE = Single Acting
NC = Normally Closed
NO = Normally Open

MOTORISATION ÉLECTRIQUE

Electric actuation

DIMENSIONS Dimensions			Couple du robinet pour motorisation Valve torque for actuation	RÉFÉRENCE Product code						
d	DN			Kit	Moteur standard	Moteur standard	Moteur failsafe (NF)	Moteur failsafe (NF)	Moteur posi	Moteur posi
mm	mm	inch.	N.m	Kit	100-240VAC / 100-350 VDC	15-30VAC / 12-48 VDC	100-240VAC / 100-350 VDC	15-30VAC / 12-48 VDC	100-240VAC / 100-350 VDC	15-30VAC / 12-48 VDC
20	15	1/2"	8,0	KIT0131	2907-39A	2907-39B	2907-39E	2907-39F	2907-40Q	2907-40R
25	20	3/4"	8,0	KIT0131	2907-39A	2907-39B	2907-39E	2907-39F	2907-40Q	2907-40R
32	25	1"	8,0	KIT0173	2907-39A	2907-39B	2907-39E	2907-39F	2907-40Q	2907-40R
40	32	1"1/4	8,0	KIT0173	2907-39A	2907-39B	2907-39E	2907-39F	2907-40Q	2907-40R
50	40	1"1/2	8,0	KIT0176	2907-39A	2907-39B	2907-39E	2907-39F	2907-40Q	2907-40R
63	50	2"	8,0	KIT0176	2907-39A	2907-39B	2907-39E	2907-39F	2907-40Q	2907-40R

Notes :
- Le dimensionnement des actionneurs pneumatiques a été effectué avec une pression d'air de 5.62 bar. Pour d'autres pressions, veuillez nous consulter.
- Le «couple du robinet pour motorisation» est le couple nécessaire pour ouvrir le robinet lorsque dP=PN et tenant compte d'une marge de sécurité.

- The sizing of pneumatic actuators was done with an air pressure of 5.62 bar. For other pressures, please contact us.
- The «valve torque for actuation» is the required torque to open the valve when dP=PN and including a safety coefficient

Tel: 01626 201092

196

www.safi-valves.com

SERIE 2027

MOTORISATION DES ROBINETS À TOURNANT SPHÉRIQUE 2 VOIES, DOUBLE UNION, SÉRIE 2027 (PVDF)
Actuation of 2-way double union ball valve, serie 2027 (PVDF)

MOTORISATION PNEUMATIQUE

Pneumatic actuation

DIMENSIONS Dimensions			Couple du robinet pour motorisation Valve torque for actuation	RÉFÉRENCE DOUBLE EFFET Product code double acting		RÉFÉRENCE SIMPLE EFFET Product code failsafe		
d	DN			Kit DE	Actionneur DE	Kit SE	Actionneur NF	Actionneur NO
mm	mm	inch.	N.m	DA Kit	DA Actuator	Failsafe Kit	NC Actuator	NO Actuator
20	15	1/2"	8,0	KIT0130	2007-73A	KIT0131	2007-73M	2007-75M
25	20	3/4"	8,0	KIT0130	2007-73A	KIT0131	2007-73M	2007-75M
32	25	1"	8,0	KIT0173	2007-73B	KIT0173	2007-73M	2007-75M
40	32	1"1/4	8,0	KIT0173	2007-73B	KIT0173	2007-73M	2007-75M
50	40	1"1/2	16,0	KIT0176	2007-73B	KIT0177	2007-73N	2007-75N
63	50	2"	16,0	KIT0176	2007-73B	KIT0177	2007-73N	2007-75N

DE = Double Effet
SE = Simple Effet
NF = Normalement Fermé
NO = Normalement Ouvert

DA = Double Acting
SE = Single Acting
NC = Normally Closed
NO = Normally Open

MOTORISATION ÉLECTRIQUE

Electric actuation

DIMENSIONS Dimensions			Couple du robinet pour motorisation Valve torque for actuation	RÉFÉRENCE Product code						
d	DN			Kit	Moteur standard	Moteur standard	Moteur failsafe (NF)	Moteur failsafe (NF)	Moteur posi	Moteur posi
mm	mm	inch.	N.m	Kit	100-240VAC / 100-350 VDC	15-30VAC / 12-48 VDC	100-240VAC / 100-350 VDC	15-30VAC / 12-48 VDC	100-240VAC / 100-350 VDC	15-30VAC / 12-48 VDC
20	15	1/2"	8,0	KIT0131	2907-39A	2907-39B	2907-39E	2907-39F	2907-40Q	2907-40R
25	20	3/4"	8,0	KIT0131	2907-39A	2907-39B	2907-39E	2907-39F	2907-40Q	2907-40R
32	25	1"	8,0	KIT0173	2907-39A	2907-39B	2907-39E	2907-39F	2907-40Q	2907-40R
40	32	1"1/4	8,0	KIT0173	2907-39A	2907-39B	2907-39E	2907-39F	2907-40Q	2907-40R
50	40	1"1/2	16,0	KIT0176	2907-40C	2907-40A	2907-40F	2907-40D	2907-40Q	2907-40R
63	50	2"	16,0	KIT0176	2907-40C	2907-40A	2907-40F	2907-40D	2907-40Q	2907-40R

Notes :
- Le dimensionnement des actionneurs pneumatiques a été effectué avec une pression d'air de 5.62 bar. Pour d'autres pressions, veuillez nous consulter.
- Le «couple du robinet pour motorisation» est le couple nécessaire pour ouvrir le robinet lorsque dP=PN et tenant compte d'une marge de sécurité.

- The sizing of pneumatic actuators was done with an air pressure of 5.62 bar. For other pressures, please contact us.
- The «valve torque for actuation» is the required torque to open the valve when dP=PN and including a safety coefficient

SERIE 2003

MOTORISATION DES ROBINETS À TOURNANT SPHÉRIQUE 3 VOIES, DOUBLE UNION, SÉRIE 2003 (PPGF)
Actuation of 3-way double union ball valve, serie 2003 (PPGF)

MOTORISATION PNEUMATIQUE

Pneumatic actuation

DIMENSIONS Dimensions			Couple du robinet pour motorisation Valve torque for actuation	RÉFÉRENCE DOUBLE EFFET Product code double acting		RÉFÉRENCE SIMPLE EFFET Product code failsafe		
d	DN			Kit DE	Actionneur DE	Kit SE	Actionneur NF	Actionneur NO
mm	mm	inch.	N.m	DA Kit	DA Actuator	Failsafe Kit	NC Actuator	NO Actuator
20	15	1/2"	7,2	KIT0010	2007-73A	KIT0006	2007-73M	2007-75M
25	20	3/4"	7,2	KIT0010	2007-73A	KIT0006	2007-73M	2007-75M
32	25	1"	16,0	KIT0173	2007-73B	KIT0174	2007-73N	2007-75N
40	32	1"1/4	16,0	KIT0173	2007-73B	KIT0174	2007-73N	2007-75N
50	40	1"1/2	16,0	KIT0176	2007-73B	KIT0177	2007-73N	2007-75N
63	50	2"	16,0	KIT0176	2007-73B	KIT0177	2007-73N	2007-75N

DE = Double Effet
SE = Simple Effet
NF = Normalement Fermé
NO = Normalement Ouvert

DA = Double Acting
SE = Single Acting
NC = Normally Closed
NO = Normally Open

MOTORISATION ÉLECTRIQUE

Electric actuation

DIMENSIONS Dimensions			Couple du robinet pour motorisation Valve torque for actuation	RÉFÉRENCE Product code						
d	DN			Kit	Moteur standard	Moteur standard	Moteur failsafe (NF)	Moteur failsafe (NF)	Moteur posi	Moteur posi
mm	mm	inch.	N.m	Kit	100-240VAC / 100-350 VDC	15-30VAC / 12-48 VDC	100-240VAC / 100-350 VDC	15-30VAC / 12-48 VDC	100-240VAC / 100-350 VDC	15-30VAC / 12-48 VDC
20	15	1/2"	7,2	KIT0006	2907-39A	2907-39B	2907-39E	2907-39F	2907-40Q	2907-40R
25	20	3/4"	7,2	KIT0006	2907-39A	2907-39B	2907-39E	2907-39F	2907-40Q	2907-40R
32	25	1"	16,0	KIT0173	2907-40C	2907-40A	2907-40F	2907-40D	2907-40Q	2907-40R
40	32	1"1/4	16,0	KIT0173	2907-40C	2907-40A	2907-40F	2907-40D	2907-40Q	2907-40R
50	40	1"1/2	16,0	KIT0176	2907-40C	2907-40A	2907-40F	2907-40D	2907-40Q	2907-40R
63	50	2"	16,0	KIT0176	2907-40C	2907-40A	2907-40F	2907-40D	2907-40Q	2907-40R

Notes : - Le dimensionnement des actionneurs pneumatiques a été effectué avec une pression d'air de 5.62 bar. Pour d'autres pressions, veuillez nous consulter.
- Le «couple du robinet pour motorisation» est le couple nécessaire pour ouvrir le robinet lorsque dP=PN et tenant compte d'une marge de sécurité.

- The sizing of pneumatic actuators was done with an air pressure of 5.62 bar. For other pressures, please contact us.
- The «valve torque for actuation» is the required torque to open the valve when dP=PN and including a safety coefficient

Tel: 01626 201092

198

www.safi-valves.com

SERIE 2035

MOTORISATION DES ROBINETS À TOURNANT SPHÉRIQUE 3 VOIES, DOUBLE UNION, SÉRIES 2035 (PVDF)
Actuation of 3-way double union ball valve, serie 2035 (PVDF)

MOTORISATION PNEUMATIQUE

Pneumatic actuation

DIMENSIONS Dimensions			Couple du robinet pour motorisation Valve torque for actuation	RÉFÉRENCE DOUBLE EFFET Product code double acting		RÉFÉRENCE SIMPLE EFFET Product code failsafe		
d	DN			Kit DE	Actionneur DE	Kit SE	Actionneur NF	Actionneur NO
mm	mm	inch.	N.m	DA Kit	DA Actuator	Failsafe Kit	NC Actuator	NO Actuator
20	15	1/2"	9,0	KIT0010	2007-73A	KIT0006	2007-73M	2007-75M
25	20	3/4"	9,0	KIT0010	2007-73A	KIT0006	2007-73M	2007-75M
32	25	1"	40,0	KIT0174	2007-73C	KIT0174	2007-84F	2007-85F
40	32	1"1/4	40,0	KIT0174	2007-73C	KIT0174	2007-84F	2007-85F
50	40	1"1/2	40,0	KIT0177	2007-73C	KIT0177	2007-84F	2007-85F
63	50	2"	48,0	KIT0177	2007-73C	KIT0177	2007-84F	2007-85F

DE = Double Effet
SE = Simple Effet
NF = Normalement Fermé
NO = Normalement Ouvert

DA = Double Acting
SE = Single Acting
NC = Normally Closed
NO = Normally Open

MOTORISATION ÉLECTRIQUE

Electric actuation

DIMENSIONS Dimensions			Couple du robinet pour motorisation Valve torque for actuation	RÉFÉRENCE Product code						
d	DN			Kit	Moteur standard	Moteur standard	Moteur failsafe (NF)	Moteur failsafe (NF)	Moteur posi	Moteur posi
mm	mm	inch.	N.m	Kit	100-240VAC / 100-350 VDC	15-30VAC / 12-48 VDC	100-240VAC / 100-350 VDC	15-30VAC / 12-48 VDC	100-240VAC / 100-350 VDC	15-30VAC / 12-48 VDC
20	15	1/2"	9,0	KIT0006	2907-40C	2907-40A	2907-40F	2907-40D	2907-40Q	2907-40R
25	20	3/4"	9,0	KIT0006	2907-40C	2907-40A	2907-40F	2907-40D	2907-40Q	2907-40R
32	25	1"	40,0	KIT0175	2907-43B	2907-43F	2907-43N	2907-43M	2907-43D	2907-43J
40	32	1"1/4	40,0	KIT0175	2907-43B	2907-43F	2907-43N	2907-43M	2907-43D	2907-43J
50	40	1"1/2	40,0	KIT0178	2907-43B	2907-43F	2907-43N	2907-43M	2907-43D	2907-43J
63	50	2"	48,0	KIT0178	2907-43B	2907-43F	2907-43N	2907-43M	2907-43D	2907-43J

Notes :
- Le dimensionnement des actionneurs pneumatiques a été effectué avec une pression d'air de 5.62 bar. Pour d'autres pressions, veuillez nous consulter.
- Le «couple du robinet pour motorisation» est le couple nécessaire pour ouvrir le robinet lorsque dP=PN et tenant compte d'une marge de sécurité.
- The sizing of pneumatic actuators was done with an air pressure of 5.62 bar. For other pressures, please contact us.
- The «valve torque for actuation» is the required torque to open the valve when dP=PN and including a safety coefficient

Tel: 01626 201092

www.safi-valves.com

quotes@tfpes.co.uk

CGV

Tel: 01626 201092

200

www.safi-valves.com

CONDITIONS GÉNÉRALES DE VENTE

General terms of sales

§1 - Application and Assertibility of the General Terms of Sale

These general terms of sale are sent or given to each Buyer to enable it to place its order.

Placement of an order entails the Buyer's full and unconditional acceptance of these general terms. The Seller's other documents such as flyers and catalogues are for information only and may not be pleaded against it by the Buyer.

No special terms may prevail over the general terms of sale unless the Seller expressly agrees otherwise in writing. No contrary term pleaded by the Buyer shall accordingly be assertible against the Seller, except as otherwise expressly agreed, regardless of when it may have been brought to its attention.

The Seller's failure to enforce these general terms of sale at any time shall not be construed as a waiver of its right to enforce any of said terms thereafter.

§2 - Orders

The orders are definitive only after they are confirmed in writing. The sales take effect only after express written acceptance of the Buyer's order in the form of an acknowledgment of receipt by the Seller.

An amendment or rescission by the Buyer of its order is allowable only if the Seller expressly accepts it and is notified thereof in writing on a date which is in its opinion far enough before the requested delivery date.

If the Seller does not agree to the amendment or rescission, the payments on account if any are non-refundable. If no payment on account is made, the Buyer will be billed an amount equivalent to 30% of the order as a cancellation penalty.

The Seller may at any time make any change in its products which it deems advisable, and alter the models shown in its flyers and catalogues without notice.

§3 - Prices

The products are supplied at the prices in effect on the date of confirmation of the Buyer's order, as quoted to it before the order was placed.

Specific orders by the Buyer are conditional on its acceptance of a preliminary estimate.

The prices are net, ex works and before VAT.

The Seller renders an invoice to the Buyer when each delivery is made. The amount of no invoice may be less than €50 excluding VAT and transportation costs.

§4 - Terms of Payment

4.1. Payment Times: Unless otherwise expressly agreed, the payments are made, within thirty days of the tenth day of the month following the month in which the delivery was made, by bank transfer.

The Seller may require the customer to make a 30% down payment with the order if the buyer's creditworthiness is impaired or if the order requires the seller to incur large expenses.

Payment as the word is used in this section means not the mere delivery of the draft but payment thereof on the agreed date payable.

4.2. Late Charges: Late charges on payments, including VAT, overdue by the Buyer shall accrue automatically to the Seller without formality or prior notice of default at the annual rate being equal to the European central bank refinancing rate increased by 10 points, namely a rate of 10% as at 1st July 2016. Default in payment shall accelerate the maturity of all sums due by the Buyer to the Seller without prejudice to any and all other action which the Seller is entitled to take against the Buyer on that account.

In addition the buyer will be automatically charged an amount of € 40 for late payment as per French commercial law n° L441-6.

In event of breach of the foregoing terms of payment, the Seller may without prejudice to any other action also suspend or cancel the delivery of the pending orders and/or suspend the discharge of its obligations and/or reduce or cancel any allowances made to the Buyer.

If a default in payment is not remedied within 48 hours of notice thereof, the Seller may rescind the sale and file a summary petition for return of the products without prejudice to recovery of any and all damages. Not only shall the order in question be rescinded but also all prior orders not paid for, whether or not delivered or in process of delivery and whether or not the price is overdue.

If payment is made by negotiable instrument, failure to return the instrument shall be deemed to be a refusal of acceptance equated with a default in payment. If the payment is made in installments, default in payment of a single installment shall accelerate the maturity of the entirety of the debt without prior notice of default.

In all of the foregoing events, the maturity of the sums due for other deliveries or for any other reason shall be accelerated if the Seller does not elect to rescind the covering orders.

The Buyer shall reimburse all the expenses of litigation incurred to recover the sums due, including attorney's fees.

Payments may be suspended or set off in no case without the Seller's prior written consent. Partial payments shall be applied to the amounts due in chronological order.

4.3. Set-Off: Penalties for late delivery or non-compliance of the products with the order may be set off against the price of the products purchased from the Seller only with its express prior written consent and only if the amounts receivable and payable set off are all accrued, due and payable.

4.4. Conditional Sale Clause: The Seller retains title to the products sold until they are paid for in full, and may repossess them in case of default in payment. Payments on account by the Buyer accrue to the Seller as liquidated damages without prejudice to any and all other actions which it may be thereby entitled to bring against the Buyer.

§5 - Deliveries

5.1. Methods: Delivery is made at the Seller's option by direct delivery of the product to the Buyer, by notice of readiness for pick-up, or by delivery to a shipper or carrier on the Seller's premises.

The Buyer shall take delivery within eight days of the notice of readiness for pick-up. Otherwise the Seller may bill it for custodial charges of €100 per diem thereafter.

5.2. Times: The deliveries depend on the availability of the products and are made in order of receipt of the orders. The Seller may make deliveries in whole or in part.

The delivery times are estimated as accurately as possible but depend on the Seller's procurement and transport potential.

Late delivery does not entitle the Buyer to damages, to withhold payments due or to cancel pending orders.

However, if the product is not delivered within one month of the estimated delivery date for any reason other than force majeure, the sale may be rescinded on either party's demand; the buyer is entitled to refund of its down payment but to no indemnity or damages.

Events of force majeure releasing the Seller from its delivery obligation include war, riot, fire, strikes, accidents and procurement difficulties.

The Seller shall promptly notify the Buyer of such events.

In any event, timely delivery may be made only if the Buyer is not in breach of its obligations to the Seller for any reason.

The costs entailed by the Buyer's special requests concerning the packing or carriage of the products which are duly agreed to in writing by the Seller will be billed extra on estimate previously accepted by the Buyer.

5.3. Receipt: The Buyer shall check the condition of the products on delivery. If it does not expressly enter reservations or make complaints in writing concerning patent defects or non-compliance of the delivered products with the order within five business days of the delivery, the products delivered by the Seller shall be deemed to be compliant with the order in quantity and quality.

The Buyer shall have the burden of proof of the defects or imperfections complained of. It shall afford the Seller every facility to ascertain and remedy such defects. It shall not remedy them itself or have them remedied.

No complaint will be entertained if the Buyer breaches its obligations under this subsection 5.3.

The Seller will at its expense promptly replace all products the patent defects in or non-compliance of which are duly proved by the Buyer.

§6 - Transfer of Title and Risks

Title to the products shall be transferred from the Seller to the Buyer only after payment of the price by the Buyer in full, regardless of the date of delivery of such products.

The risks of loss of or damage to the Seller's products shall be transferred when the products leave its premises. The products

travel at the risk of the Buyer which may, in event of damage, assert all claims against the carrier as provided by law.

The Buyer shall until the transfer of title accordingly insure such products under an ad hoc policy for the Seller's benefit against the risks of loss and damage due to fortuitous event or otherwise, and supply the Seller with proof of such insurance at its request.

§7 - The Seller's Liability - Warranty

The products delivered by the Seller are, all applicable legal provisions to the contrary notwithstanding, warranted for 12 months from the date of delivery against all latent defects and defects in materials, design or manufacture affecting the products which make them unfit for use. Said warranty period is not extended by services rendered by the Seller pursuant to the warranty.

All warranties are avoided in case of improper use, negligence or faulty maintenance or storage by the Buyer, any alteration of or work on the original product, disregard of the installation, use and maintenance instructions, normal wear or force majeure.

The Purchaser must ensure compatibility of the product with the use that it intends to make of it, including, this list not being exhaustive, conditions of temperature, flow, pressure, and the nature and composition of the liquids transported, and such use must be in accordance with the technical specifications provided with the sales offer. Any doubts by the Purchaser concerning the compatibility of the product ordered and the use that it intends to make of it after reading the technical specifications must be addressed to the Vendor within twenty four hours of receipt of the technical specifications.

Where the Vendor provides the Purchaser with a product subject to specific conditions for use that the Purchaser has pre-defined and where these specific conditions have been fully set out either in the Vendor's sales offer or in its order confirmation, the Vendor cannot be held liable if the information provided is incomplete and/or inaccurate.

In order to exercise its rights, the Buyer must, on pain of loss of all rights of action related thereto, inform the Seller in writing of the defects and supply it with proof thereof within 15 days of the discovery thereof.

The Seller may either replace the warranted products which are found to be defective or have them repaired.

In connection with the supply of separate parts relating to the products delivered, the Vendor undertakes to ensure the availability of such separate parts for a period of two years with effect from the initial date of delivery of the products. For separate parts being purchased to a third company, the Vendor will not be responsible for lack of availability.

The available separate parts shall then be delivered to the Purchaser within a maximum time limit of 2 months with effect from the receipt of the order. These parts shall be invoiced in accordance with the prices in force as at the date of delivery.

In case of return of product for technical expertise, fees of € 150 without VAT will be invoiced to the purchaser if the concerned product was initially sold more than 2 years ago.

§8 - Industrial and Intellectual Property Rights

The Seller retains title to all of the intellectual and/or industrial rights and know-how to which the Buyer may have access in connection with the execution of the order.

The expenses entailed by studies made at the Buyer's request not followed by an order are incumbent on it. The media shall be returned to the Seller.

§9 - Litigation

All litigation to which this contract may give risk concerning its validity, interpretation, performance or cancellation, or the consequences thereof or of transactions and proceedings appurtenant thereto, shall be subject to the exclusive jurisdiction of the ROMANS commercial court.

§10 - Language of the Contract - Governing Law

This contract is governed by and subject to French law.

A translation into English has been made. However, in case of conflict, the French-language version shall prevail.

RETROUVEZ-NOUS SUR NOTRE SITE WEB FIND US ON OUR OUR WEBSITE

CATALOGUE EN LIGNE

Online catalogue



Trouvez votre produit dans notre catalogue et obtenez votre devis en quelques clics.

Find your product in our catalog and get your quote in a few clicks.

PARCOUREZ NOTRE CATALOGUE
Browse our catalog

SERVICES ET SUPPORT

Services and support

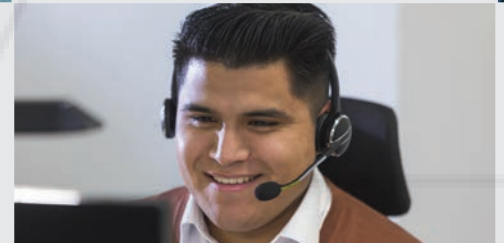

Notre service client est à votre écoute quelle que soit votre demande.

Our customer service is at your disposal whatever your request.

EXPLIQUEZ-NOUS VOTRE BESOIN
Explain your need

INFORMATIONS & SALONS

News and exhibitions



Retrouvez ici toutes nos actualités et les salons où vous pouvez nous rencontrer.

Find here all our news and the exhibitions where can meet us.

PARCOUREZ NOS ACTUALITÉS
Browse our news

RÉSEAU & CONTACTS

Network and contacts



Découvrez notre réseau commercial et comment nous contacter.

Discover our commercial network and how to contact us.

CONTACTEZ-NOUS
Contact us

SAFI France (HQ)

13, av. Jacques Moison - BP 1
26770 TAULIGNAN CEDEX
FRANCE
Tél. : (+33) 4 75 53 56 29
Fax : (+33) 4 75 53 62 78
info@safi-valves.com

SAFI UK

35 Holton Road
Holton Heath Trading Park
POOLE Dorset - BH16 6LT
UNITED KINGDOM
Tél. : (+44) 1202 624618
Fax : (+44) 1202 628500
sales@safi-valves.com

SAFI Deutschland

Kunststoffarmaturen
Vertriebs GmbH
Jahnstrasse 29
64319 PFUNGSTADT
DEUTSCHLAND
Tél. : (+49) 61 57 81 919
Fax : (+49) 61 57 82 025
info-deutschland@safi-valves.com

SAFI Fabrica de valvulas

C/ Carboners, 35
Pol. Ind. La Cometa
43700 EL VENDRELL
TARRAGONA-ESPAÑA
Tel. : (+34) 977 665 147
Fax : (+34) 977 664 989
info@safi-valvulas.com

SAFI América

Las Garzas Trade Center
Las Garzas #950
Quilicura
SANTIAGO - CHILE
Tfno. : (+56 2) 2 510 3500
info@safi-america.com

SAFI América Perú

Av. José Pardo #601
Oficina 1301
Miraflores
LIMA - PERÚ
Tfno. : (+51) 1 699 8100
peru@safi-america.com

VOTRE CONTACT
Your contact



Thermoplastic Valve Solutions

Tel: 01626 201092